

---

# Health and environmental impacts in the Norwegian border area related to local Russian industrial emissions

Knowledge status

Authors:

Torkjel M. Sandanger (UiT/NILU), Erik Anda (UiT), Tore F. Berglen (NILU),  
Anita Evenset (Akvaplan-niva), Guttorm Christensen (Akvaplan-niva) and  
Eldbjørg S. Heimstad (NILU)



**Scientific report**



## Preface

*NILU - Norwegian Institute for Air Research has in collaboration with the University of Tromsø (Institute of Community Medicine) and Akvaplan-niva, performed a literature review of impacts from local industrial pollution on ecosystem and human health in the Norwegian border region to Russia.*

During the last decades several studies addressing the state of the environment in the Norwegian-Russian border region have been conducted. There has been a need to assess and clarify whether the pollution from Nikel and Zapoljarny has negative effects on human health and the environment, both in Norway and in Russia. These investigations have partly been conducted through Norwegian or Russian monitoring programs, bilateral (Norwegian-Russian) or trilateral (Norwegian-Finnish-Russian) cooperation. However, the results from the studies are scattered and not easily accessible, and some of the studies are outdated.

At present there is a need to compile updated knowledge concerning the state of the environment, potential impacts on human health as well as the food security situation. The requirement includes a literature survey of the severity of exposure from pollution, the geographic distribution of the pollution (including time trends) and newly acquired exposure - effect relationships between pollution and human health, independent of the maximum exposure levels set forth by local governments.

The aim is to identify important knowledge gaps in relation to environmental and health effects so that stakeholders, scientists and governmental institutions together can decide on the appropriate future cause of action.

This report is first and foremost a summary of knowledge status, based on literature and ongoing studies on environmental and health impacts, in the Norwegian-Russian border area. The state of the environment, as described in this report, is largely based on information from the Pasvik Programme and additional data (e.g. data post 2007) has been added when available. Concerning human health impacts, we have chosen a broader perspective exploring total impact (air- and food exposure) from local Norwegian and Russian sources and long range transported pollution. The human health risks and food security assessments are related and linked to the ongoing Kolarctic KO467 project “Food and health security in the Norwegian, Finnish and Russia border region: linking local industries, communities and socio-economic impacts”.



# Contents

	Side
<b>Preface</b> .....	<b>1</b>
<b>Summary</b> .....	<b>5</b>
<b>1 Introduction</b> .....	<b>9</b>
<b>2 Air and precipitation quality</b> .....	<b>11</b>
2.1 Main sources in the border areas .....	11
2.2 Threshold values and air quality standards.....	12
2.3 Meteorology .....	13
2.4 Monitoring network.....	13
2.5 Updated results .....	19
2.6 Other topics, knowledge gaps.....	25
<b>3 Freshwater ecosystems</b> .....	<b>26</b>
3.1 Pollution sources .....	27
3.2 Lakes and rivers.....	27
3.2.1 Surface water quality .....	28
3.2.2 Lake sediment.....	33
3.2.3 Fish in lakes and rivers .....	41
3.3 Pasvik watercourse .....	43
3.3.1 Water quality .....	44
3.3.2 Sediment.....	45
3.3.3 Fish.....	46
<b>4 Marine ecosystems</b> .....	<b>49</b>
4.1 Sediment.....	49
4.2 Fish and invertebrates.....	50
<b>5 The Terrestrial environment</b> .....	<b>55</b>
5.1 Soil .....	55
5.2 Plants .....	56
5.3 Edible berries.....	58
5.4 Birds and mammals .....	58
<b>6 Human health risks and food security</b> .....	<b>60</b>
6.1 The Norwegian Russian Health Study 1994-1995 .....	60
6.2 Allergic disease and asthma .....	61
6.3 Cardiovascular disease .....	63
6.4 Cancer.....	64
6.5 Food security .....	64
<b>7 Conclusions/knowledge gaps</b> .....	<b>65</b>
<b>8 References</b> .....	<b>70</b>
<b>Appendix A</b> .....	<b>81</b>



## Summary

The industrial facilities at Zapolyarny and Nikel in Russia are approximately 30 km apart and approximately 15 and 5 km from the Norwegian border, respectively. The main pollutants emitted into air are sulphur dioxide (SO<sub>2</sub>) and toxic elements, such as nickel (Ni) and copper (Cu), often attached to dust particles. Additionally, large quantities of metals are discharged into local water bodies through wastewater. The Norwegian-Russian border area has received considerable attention during the last decades because of local industrial pollution, and in this report impacts from local industrial pollution on ecosystem and human health in the Norwegian border region to Russia are presented.

**Air:** Although annual industrial emissions of SO<sub>2</sub> from the Russian smelters near the Norwegian border have declined over the past 30 years, there are still episodes where air concentrations exceed Norwegian threshold values at Svanvik and in Karpdalen. Air concentrations of toxic elements such as Ni and Cu do not exceed European and Norwegian target values. However, it is worth noting that concentrations of Ni, Cu and Co (cobalt) in precipitation have increased considerably after year 2004. This increase is also observed in freshwater systems in the area. The trends in concentrations of toxic elements do not correspond with emission estimates provided by Kola Mining and Metallurgical Company (Kola MMC).

**Lakes and rivers:** Acidification of smaller and larger lakes, resulting in serious effects on fish populations, was reported in studies from the mid 1980-ties. But since 1987 all the Norwegian lakes have shown significant decreasing trends in sulphate and hence an improvement in pH-status.

In three Norwegian lakes (Bårsjarvi, St. Valvatnet and Langvatnet) in the border region, water concentrations of Ni have increased from 2005 and until today. Average concentrations of Ni and Cu in water from lakes on Jarfjord Mountain are currently (2010-2012) the highest ever measured. A study from 2010 showed that the concentrations of Cu and Ni in lake sediments were high to extremely high in Norwegian lakes up to 20 km from the Russian smelters. Elevated concentrations were also found for lead (Pb), Co, mercury (Hg), arsenic (As) and cadmium (Cd). Increasing Ni, Cu, As and Hg concentrations from sub-surface to surface sediments were found for lakes at intermediate distances (20-60 km). This may reflect recent changes in atmospheric depositions, as shown in nearby Norwegian areas. The regional lake surveys from 2004 - 2006 also showed a sharp increase of Ni and Cu in the upper part of the sediment profile. New studies (Rognerud *et al* 2013) indicate an escalation in Hg emission from the smelters. No

measurements of contaminants have been carried out in fish from lakes, except from the Pasvik watercourse.

Even though Kola MMC report annual reductions in surface water discharge, no effect of this reduction in Ni and Cu concentrations has been observed in the Pasvik watercourse over the past 9 years. Elevated Ni- and Cu-levels have been documented in fish from lakes in the lower part of the Pasvik watercourse, in Lake Vaggatem and Lake Skrukkebukta. Analyses of sediments and fish from the Pasvik watercourse for polyaromatic hydrocarbons (PAHs) and persistent organic pollutants (POPs) have shown elevated levels downstream the smelters compared to upstream. This indicates that emissions and runoff from the industrial activities associated with the Nickel smelters are the main source for these contaminants.

**Terrestrial environment:** In soil samples elevated heavy metal concentrations extend up to a distance of 30 - 40 km from the smelters. Accumulation of metals in the litter and organic layer is reflected in heavy metal concentrations in plants, such as grasses and dwarf shrubs, as well as in the needles and leaves of trees. National surveys of mosses reveal a steady increase from year 1997 to 2010 of Ni and Cu levels in the Norwegian part of the border area. Even though the area close to the smelters receives acidic precipitation and deposition, the soil in the immediate vicinity of the smelters is not suffering from acidification, due to calcareous bedrock.

Samples of edible berries on the Finnish, Russian and Norwegian side of the border show elevated Ni and Cu concentrations and highest levels near the smelters. A study from 2008 analysed samples of cloudberries from Sør-Varanger for metals. Concentrations of Cu, Ni, Cd and particularly manganese (Mn) were notably higher in the areas close to Nickel than more distant areas, showing that the emissions from the smelting industry still were affecting the surroundings. Metal levels in cloudberries were lower in 2008 than in 1992. However, new analysis are recommended to check the present status and if there is year to year variations.

Studies from Finland and Russia have shown that there are high metal levels in birds residing close to non-ferrous smelters. This may in turn affect bird population densities; however, data on bird densities from the Norwegian border to Russia area is not available.

The high levels of metals in the terrestrial environment have so far not been reflected in reindeer meat. Elevated dioxin levels have been reported in one sample of reindeer meat from the Svanvik area and new dioxin analyses of a representative amount of samples are recommended in order to conclude.

**Human health:** A large health study carried out on the Norwegian and the Russian side of the border in 1994-95 concluded that no major health effects



could be ascribed to Ni and SO<sub>2</sub> pollution on either sides of the border. It was also concluded in a similar way that Ni allergy is not associated with Ni exposure from the Russian smelters and that short term increase in SO<sub>2</sub> exposure was not significantly associated with lung function decrements. However, in light of recent studies, new available information on causative relationships and modern scientific methods, it is clear that episodes of SO<sub>2</sub> (and particulate matter) on the Norwegian side of the border have the potential to affect both the incidence and the severity of existing respiratory diseases, especially in particularly vulnerable groups, such as the elderly and children. There is, however, little information about the proportion of the local population that is affected by these SO<sub>2</sub> episodes, both in terms of actual exposure and the number of persons that are particularly vulnerable (the true prevalence of asthma/allergy/other lung disease and cardiovascular disease).

It seems evident that concentrations in the Norwegian environment of certain toxic elements have been increasing lately, but at the same time local foods like reindeer meat has not shown the same increase.

**Marin environment:** The marine ecosystem can be affected by pollution from the Russian smelters through the Pasvik watercourse. However, there are many other potential sources for contaminants in the marine ecosystem of the Barents Sea, and it is therefore difficult to assign any contaminants in marine sediment, invertebrates, fish, seabirds or mammals directly to emissions/discharges from the smelters on the Kola Peninsula. Generally, contaminant levels are low in sediment, invertebrates and fish from the marine sector of the border area. However, elevated levels of metals and organic contaminants are found in harbour areas and close to major settlements.

### **Gaps of knowledge:**

#### *Air measurements*

- Particulate matter (PM 2.5 and 10) measurements should be conducted in Kirkenes and Svanvik/Karpdalen
- Measurements of SO<sub>2</sub>, using passive samplers, should be performed in Kirkenes/Hesseng.

#### *Freshwater environment*

- Lake sediment cores should be dated and analysed for metals and POPs to reveal historical trends. This is the best method for demonstrating time trends.
- Freshwater fish from the Pasvik watercourse should be analysed for organic contaminants.
- Fish from lakes outside the Pasvik watercourse (Jarfjord area) should be analysed for toxic elements.

- A monitoring program for Hg in lake sediment and fish (perch) should be established.

#### *Terrestrial environment*

- The risk related to intake of edible berries and mushrooms collected in the border area should be estimated.
- A representative number of reindeer meat samples should be analysed for dioxins.

#### *Human health and food security*

- Updated information on what local food is used and to what extent should be acquired through questionnaire based studies.
- Dioxin concentrations in humans should be determined over time
- Human health risk related to local SO<sub>2</sub>, PM and nickel sulphate exposure should be assessed:
  - Identify and quantify population exposed
  - Identify and quantify population at risk
- There is a clear need to repeat the Norwegian Russian Health study from 1994-95.

Independent Norwegian monitoring programs on air/precipitation (Berglen *et al.*, 2011), freshwater lakes (Schartau *et al.*, 2011) and mosses (Steinnes *et al.*, 2011a, 2011b) reveal all an increased deposition of metals to the Norwegian border area. We therefore recommend that this knowledge is reflected in a near future study with a broad investigation of metals and other pollutants in local food items such as freshwater fish, birds, reindeer, edible berries and mushrooms.

It is recommended that an interactive web based tool/map is developed, where all the information from the different studies in the border region can be gathered and presented. This will be a valuable tool when risk assessments are to be performed, and can be an asset both for policy makers, the local population and the research community.

## 1 Introduction

The Norwegian-Russian border area has received considerable attention during the last decades because of local industrial pollution. The industrial facilities at Zapolyarny and Nickel in Russia are approximately 30 km apart and approximately 15 and 5 km from the Norwegian border, respectively. The main pollutants emitted into air are sulphur dioxide and toxic metals, such as nickel and copper, often attached to dust particles. Additionally, large quantities of metals are discharged into local water bodies through wastewater.

The area covered by this report is the border regions between Norway, Finland and Russia (Figure 1) with special emphasis on knowledge status in the Norwegian part of the region. The study area comprises the region where the north-western corner of the Euro- Siberian taiga meets the barren, tundra coast of the Barents Sea. Two principal freshwater bodies dominate the region: the River Pasvik and Lake Inari. The region also contains several smaller river systems as well as many tiny streams and lakes scattered through the upland forests and vegetation-free mountainous areas.

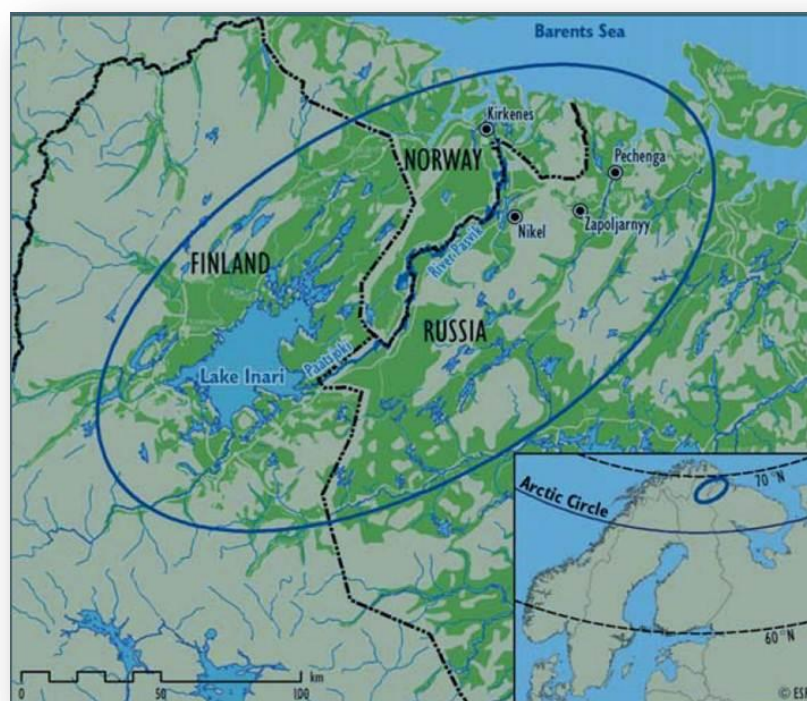


Figure 1 Border area between Norway, Finland and Russia. (Map from Pasvik Programme – Summary report).

Traditionally this border area has been home to the Saami people and reindeer herders. Fishing and farming activities are still important in the area, but in the major settlements of the region (Kirkenes, Pechenga, Nickel and Zapoljarny) most people are employed by the mining or metallurgic industry.

It is a well known fact that the area is heavily affected by emissions from the metallurgic industry. In addition, deposition of long-range transported contaminants occur in the region, just as elsewhere in the Arctic, but this contribution is minor compared with the pollution from local sources. The environmental status in the Norwegian-Finnish-Russian border area has recently been evaluated and described through the "Pasvik Programme". This program was a cooperative effort between more than twenty research institutes and environmental authorities from Norway, Finland and Russia. The project was funded mainly as an Interreg IIIA Kolarctic program and was initiated in 2003. The aim of the Pasvik Programme was to develop and implement a trilateral environmental monitoring and assessment programme related to emissions from the Pechenga -Nickel industrial complex. In 2007, a status report that describes the state of the environment in the Pasvik-Inari area and observed changes during the last ten years (in the wake of decreasing emissions from the Pechenganikel combined enterprises) was published. The environmental status descriptions of terrestrial and freshwater ecosystems in this report are largely based on information from the Pasvik Programme. However, additional data (e.g. data post 2007) has been added when available.

Traditionally, the population in the region has been concerned about possible health effects related to pollution. People ask for instance if it is safe to eat berries, game and fish, drink water from small streams and if there are potential health risks associated to the air pollution (pers. comm. with County Governor of Finnmark). The main contributor to this contamination is the Russian nickel industry, but also the Norwegian metallurgical industry and other mining activities are potential contributors.

The aim of the present report is to give an overview of the pollution status on the Norwegian side of the border (eastern Finnmark), with special emphasis on potential risk elements for environment and humans living in the region.

The study is first and foremost a summary of knowledge status, based on literature and ongoing studies on environmental and health impacts, in the Norwegian-Russian border area. The state of the environment, as described in this report, is largely based on information from the Pasvik Programme and additional data (e.g. data post 2007) has been added when available. Concerning human health impacts, we have chosen a broader perspective exploring total impact (air- and food exposure) from local Norwegian and Russian sources and long range transported pollution. The human health risks and food security assessments are

related and linked to the ongoing Kolarctic KO467 project “Food and health security in the Norwegian, Finnish and Russia border region: linking local industries, communities and socio-economic impacts”.

## **2 Air and precipitation quality**

Although the focus in this report is the state of the environment in the Norwegian part of the border areas between Russia and Norway, this chapter and the additional information given in Appendix A will also bring information about the Russian and Finnish part. There are two reasons for this:

- The Pasvik report from 2007 showed results from monitoring stations from the North Calotte, i.e. Finnish Lapland, Finnmark and Murmansk oblast. The same stations have been chosen here so that the updated results can be compared to the 2007 report.
- There exist national monitoring programs in all three countries where the results are published in reports written in Finnish, Norwegian and Russian respectively. These results are often difficult to assess for colleagues in the two other countries. Here we refer to some of these studies.

### **2.1 Main sources in the border areas**

Concerning emissions to air there are two important sources in the border areas, the briquetting facility in Zapolyarny and the smelting facility in Nikel. Both are owned and operated by Kola MMC. The facilities emit SO<sub>2</sub> and toxic elements like Ni and Cu, but also components like particulate matter (PM), water vapour, Hg and NO<sub>x</sub>. The emissions of SO<sub>2</sub> have decreased during the past 30 years. One obvious reason for this decrease is the use of local ore rather than ores from Siberia. In the 1980's ore was transported from Norilsk to Kola for processing. This Siberian ore had a much higher content of sulphur (up to ~24%). As a result the total emissions from Nikel and Zapolyarny were more than 400 000 tonnes SO<sub>2</sub> per year in the 1980's. Now the emissions have been reduced to about 100 000 tonnes SO<sub>2</sub> per year (i.e. to ¼). There are about 40 000 tonnes SO<sub>2</sub> emitted annually from Zapolyarny and 60 000 tonnes from Nikel, see Appendix A, Figure A.1 for more information. There is a technical upgrade taking place in Zapolyarny with installation of a new production line. In the future there will be a process of drying the briquettes rather than roasting. Hence the emissions from Zapolyarny will be reduced to 1'000 tonnes SO<sub>2</sub> per year. However the emissions from Nikel will increase, so in total there will hardly be any reduction.

The official reported emissions of Ni and Cu add up to 330 tonnes and 158 tonnes per year respectively (numbers from Kola MMC, year 2009, see Appendix A, Figure A.1.)

## 2.2 Threshold values and air quality standards

*Table 1 Limit values and national target values for SO<sub>2</sub> concentration to protect human health and ecosystems in the EU/EEA, Norway and Russia.*

Type	Effects on	Valid within	Hourly avg. (µg/m <sup>3</sup> )	Daily avg. (µg/m <sup>3</sup> )	October-March (µg/m <sup>3</sup> )	Yearly avg. (µg/m <sup>3</sup> )	Number of allowed exceedances per calendar year	
Limit value	Health	EU / EEA	350				24	
Limit value	Health	EU / EEA		125			3	
Target value	Health	Norway		90			0	
Limit value	Ecosystems	EU / EEA			20	20	0	
WMO guidelines	Health	World	500 (10 min. avg.)					
Maximum permissible concentration	Health	Russia	500 (hr avg.)					

*Table 2 EU/EEA target values for Arsenic, Cadmium, and Nickel, in the PM<sub>10</sub> fraction.*<sup>1</sup>

Pollutant	Yearly average (ng/m <sup>3</sup> )
Arsenic	6
Cadmium	5
Nickel	20

In Russia the allowable norm for toxic elements is 1000 ng/m<sup>3</sup> for Ni and 2000 ng/m<sup>3</sup> for Cu respectively on a weekly basis.

It should also be mentioned that in Russia the air quality in cities is evaluated according to an air quality standard including several different parameters. One important parameter is the highest allowable concentration (PDK). Then three other parameters are compared to PDK;

- Standard index (SI), the highest maximum concentration divided by PDK
- NP, i.e. the exceedance rate of PDK (in percent) and finally
- IZA<sub>(5)</sub> that is a complex index that shows the total load of pollution in the city based on the five components with highest concentration.

<sup>1</sup> <http://www.lovddata.no/for/sf/md/xd-20040601-0931.html#map018> [ACCESSED 01-02-2013]

## 2.3 Meteorology

Meteorology, especially wind speed, wind direction and atmospheric stability is important for the dispersion of the pollution from the smelter facilities. Concerning wind direction there is a distinct seasonal difference between summer and winter. In summertime the wind direction will vary (“coming from all directions”), although the frequency of wind from south and from north-east is somewhat more pronounced. In wintertime the prevailing wind direction is from the south, more than 50% of the time. In this situation the wind brings the pollution from the Nickel smelter away from the city and northwards towards Jarfjord Mountains and the Barents Sea. As for wind speed there are more calm conditions in winter time, typically 20% calm conditions in winter vs. typically 10% in summertime. There are also more stable conditions in winter time. Radiative cooling of the ground sets up a temperature profile ( $\Delta T = T_{10m} - T_{2m}$ ) where the temperature increases with height. This gives very stable conditions with slow vertical mixing. Hence the emissions from the smelter are transported horizontally, mostly towards the north, but there is hardly any vertical mixing. Appendix A, Figure A.2 shows wind roses for Svanvik for summer 2011 and winter 2011/12.

## 2.4 Monitoring network

Contact person: Tore Flatlandsmo Berglen, NILU (tfb@nilu.no)

Both Norway, Finland and Russia have monitoring stations in the area studied in this report. These stations are either part of the national system, or they are part of international networks like The European Monitoring and Evaluation Programme (EMEP), The Global Atmosphere Watch (GAW) etc. The most relevant stations for this study are listed in Table 3.

### Norway

In Norway the monitoring program in the border areas is performed by NILU and is currently funded by the Ministry of Environment (MD) and the Norwegian Environment Agency. NILU has been monitoring air pollutants in Sør-Varanger municipality since 1974 and has long time series of data. At the moment there are four stations in operation, two well equipped stations at Svanvik and Karpdalen (SO<sub>2</sub> monitors, meteorology, toxic elements) in addition to Karpbukt (main components in precipitation) and Viksjøfjell (SO<sub>2</sub> passive samplers), see Figure 2 for more details and geographical location of the stations.

Data from Svanvik and Karpdalen are published online in near real time (NRT) through the [luftkvalitet.info](http://luftkvalitet.info) web portal<sup>2</sup>. At present no particulate matter (PM) data are reported.

Stations with high time resolution (monitors) also do measurements of meteorology (wind direction, wind speed, temperature, relative humidity, stability (only Svanvik) and atmospheric pressure (only Karpdalen)). The reason for monitoring meteorology is to better describe the meteorological conditions in the area and thereby quantify and understand the dispersion of pollution from the nickel smelters. The Norwegian Met Office ([met.no](http://met.no)) also distributes meteorological data online (see [www.yr.no](http://www.yr.no) and [eKlima.met.no](http://eKlima.met.no)).



*Figure 2 Norwegian monitoring stations for air and precipitation quality in the border areas. The stations SOV 1, SOV 2 and SOV 3 were former Soviet/Russian stations funded by Norwegian authorities.*

<sup>2</sup> <http://www.luftkvalitet.info/> ACCESSED [31-01-2013]



Data from the former EMEP station in Karasjok (NO55) is also reported here. This station was earlier located at Jergul, and was moved to Karasjok in 1997. Then finally the Karasjok station was closed down in 2010 (last year of data) and will probably not be reopened. In Norway NILU is responsible both for the EMEP air quality monitoring and the monitoring program in the border areas.

In Norway the results from the monitoring project funded by the Norwegian Environment Agency and the Ministry is published every year, containing data from 1. April – 31. March the following year. The latest report covers the period 1. April 2011 – 31. March 2012 (Berglen *et al.*, 2012). To make the results available for those unfamiliar with the Norwegian language the summary is translated into the Russian, Finnish and English.

Between 1988 and 1991 there was an extensive baseline study performed in the border areas with both Norwegian and Soviet scientists. The results from this monitoring were published in several Norwegian status reports (Sivertsen *et al.*, 1991) In addition there are a long range of annual reports with data from the monitoring project that can be found at the NILU web page.

## **Finland**

Contact person: Jussi Paatero ([Jussi.Paatero@fmi.fi](mailto:Jussi.Paatero@fmi.fi))

In Finland the Finnish Meteorological Institute, FMI (<http://en.ilmatieteenlaitos.fi/>) is responsible for the monitoring network, both the EMEP stations and the national network. There are 5 stations in Northern Finland relevant for this study, the EMEP stations Kevo (FI08), Oulanka (FI22R), Pallas Matorova (FI36R) and Pallas Sammaltunturi (FI96G) in addition to the station in Raja-Jooseppi (Enare municipality). The stations in the EMEP network report data to the Chemical Coordinating Centre (CCC, located at NILU, data for 2010 are now open to the public), while data from Raja-Joseppi can be found at the portal Air Quality in Finland (“Ilmanlaatuportaali”, available in Finnish, Swedish and English)<sup>3</sup>. The Sevetijärvi station ceased operation some years ago and will most probably not be reopened.

Results concerning Lapland from the Finnish national monitoring program are published in annual reports. These reports are in Finnish, but the figure captions and table captions have been translated to English. The latest report (Peltola and Sarala, 2012) contain data up to 2010 and can be downloaded at the Arctic

---

<sup>3</sup> <http://www.ilmanlaatu.fi/> and <http://www.ilmanlaatu.fi/ilmanynt/nyt/ilmanynt.php> [ACCESSED 31-01-2013]

Research Society web page<sup>4</sup>. The topics discussed and analyzed cover not only air quality in Lapland, but also natural geochemical characteristics of soil, environmental radioactive surveillance, bioindicators, etc.

The Pallas station is also part of the GAW (Global Atmospheric Watch) and TCCON (Total Carbon Column Observing Network) networks, see Appendix A for more information.

---

<sup>4</sup> <http://www.lapintutkimusseura.fi/files/Acta%20Lapponica%20Fenniae%2024.pdf> [ACCESSED 31-01-2013]

Table 3: Monitoring stations in the border areas, air quality and precipitation

Station		Air									Precipitation				
		continuous			Daily			weekly	monthly		Daily	weekly		monthly	
		Meteo	O <sub>3</sub>	SO <sub>2</sub>	SO <sub>2</sub> CO HCHO	particles	NO <sub>2</sub>	heavy metals	heavy metals	Ben- zap- yren(e)	main comp.	main comp.	heavy metals	heavy metals	main comp.
Norway															
Svanvik	69°27'N, 30°02'E	X		x									x <sup>a</sup>		
Karpbukt	69°40'N, 30°22'E											x			
Karpdalen		X		X											
Viksjøfjell															
Karasjok	69°28'N, 25°13'E		X				x				X		x <sup>b</sup>		
Finland															
Raja-Joseppi	68°29'N, 28°18'E	X		x											
Kevo	69°45'N, 27°00'E	X		x									x <sup>a</sup>	x	
Oulanka															
Matorova (Pallas)	68° 00'N, 24°15'E	X							x <sup>d</sup>				x <sup>d</sup>		
Sammaltunturi	67°58'N, 24°07'E			x											
Russia															
Nikel (MUGMS)	69°24'N, 30°20'E	X P5,P6		XNILU		X P5,P6	X P5,P6	X <sup>c</sup> P5		X <sub>P6</sub>					
Zapolyarny	69°25'N, 30°12'E				x	x	x								
Jäniskoski	69°00'N, 28°80'E	X													x

## Russia

Contact persons: Tatyana Korotkova (MUGMS) and Olga Mokrotovarova (Director MUGMS), [cms@mtaskro.ru](mailto:cms@mtaskro.ru)

Murmansk HydroMeteorological Institute (MUGMS) in Murmansk<sup>5</sup> is responsible for the regional monitoring network aimed at monitoring air pollution in cities. Within Murmansk oblast/county, MUGMS has monitoring stations in Murmansk (6 stations), Kola (meteorological station), Apatity (2 stations), Kirovsk, Kandalaksha (2 stations), Monchegorsk (2 stations), Olenegorsk, Nickel (2 stations) and Zapolyarny (Polar), in all 18 stations in 9 cities<sup>6</sup> (see Figure 3). Some results from these stations are published on the web on a monthly basis<sup>7</sup>. In the same manner they also publish a warning to the public in case of expected severe air pollution episodes.

For air pollution and deposition in the border areas, the meteorological data, SO<sub>2</sub> and heavy metals are the ones that receive most attention. But MUGMS also monitor various other components like Particulate Matter (PM), formaldehyde (CH<sub>2</sub>O), benz(a)pyrene, NO<sub>x</sub> and others. As described in chapter 2.2 the air quality in Russian cities is compared to an air quality standard composed of 5 different pollutants.



Figure 3 The MUGMS monitoring network in Murmansk oblast.

<sup>5</sup> <http://www.kolgimet.ru/> [ACCESSED 31-01-2013]

<sup>6</sup> [http://www.kolgimet.ru/index.php?option=com\\_content&view=article&id=65&Itemid=72](http://www.kolgimet.ru/index.php?option=com_content&view=article&id=65&Itemid=72) [Accessed 31-01-2013]

<sup>7</sup> [http://www.kolgimet.ru/index.php?option=com\\_content&view=article&id=54&Itemid=86](http://www.kolgimet.ru/index.php?option=com_content&view=article&id=54&Itemid=86) [ACCESSED 31-01-2013]

Reports on the state of the environment in Murmansk oblast are published annually by the local government. These reports cover not only air, but fresh water, sea water, waste water, emissions of toxic substances, etc.

In addition, there is one Russian EMEP station in the border areas, Jäniskoski located along the Pasvik river close to the Finnish border, not far downstream the outflow of Lake Inari. This station is operated by Institute of Global Climate and Ecology. Data from Jäniskoski is reported in the annual EMEP reports (see Ch 8 Reference list).

## 2.5 Updated results

The Pasvik report in 2007 gave a broad overview of the environmental situation in the border areas. Since then there has been no coordinated effort to gather coherent information from all three countries. Nevertheless there are national reports published regularly with updated results. The purpose of these reports is often to inform national authorities and the public, i.e. domestic use only. Hence they are mostly written in Norwegian, Finnish and Russian, respectively, rather than English. This makes these reports difficult to assess for foreign colleagues.

### SO<sub>2</sub> in air

The most important results from the two Norwegian stations Svanvik and Karpdalen are given in Table 4. At both stations short term concentrations of SO<sub>2</sub> (i.e. 10 minutes average) higher than 1000 µg/m<sup>3</sup> may be observed. In addition, maximum hourly mean concentrations exceeded 800 µg/m<sup>3</sup> compared to the threshold value of 350 µg/m<sup>3</sup>. Please note that during the last two years Karpdalen have experienced the highest concentrations, even though Karpdalen is located further away from Nikel than Svanvik. This is due to the prevailing wind direction from south during wintertime (ch. 2.3) that brings the pollution towards Jarfjord north of Nikel.

During the winter 2010/11 there was an extraordinary situation in Karpdalen with 102 hourly mean values of SO<sub>2</sub> above 350 µg/m<sup>3</sup> (24 allowed exceedances per calendar year, see Table 4). This also implies that the air quality standards valid for Norway were violated both for the calendar years 2010 and 2011 in Karpdalen.

Table 4: Key values for SO<sub>2</sub> measurements taken from 01 April 2010 – 31 March 2011 and 01 April 2011 – 31 March 2012 (Berglen et al., 2011 and 2012 respectively).

<b>01 April 2010 – 31 March 2011</b>	<b>Svanvik</b>	<b>Karpdalen</b>
Highest 10 minute value µg/m <sup>3</sup>	620	917
Highest hourly average value µg/m <sup>3</sup>	433	854
# Hourly average values > 350 µg/m <sup>3</sup> summer	6	4
# Hourly average values > 350 µg/m <sup>3</sup> winter	0	102
Highest daily average µg/m <sup>3</sup> summer	156	94.9
Highest daily average µg/m <sup>3</sup> winter	96	507
# Daily averages > 125 µg/m <sup>3</sup>	1	15
# Daily averages > 90 µg/m <sup>3</sup>	6	20
Average value µg/m <sup>3</sup> summer	7.4	9.4
Average value µg/m <sup>3</sup> winter	8.5	39.1
<b>01 April 2011 – 31 March 2012</b>		
Highest 10 minute value µg/m <sup>3</sup>	1099	1732
Highest hourly average value µg/m <sup>3</sup>	858	838
# Hourly average values > 350 µg/m <sup>3</sup> summer	6	3
# Hourly average values > 350 µg/m <sup>3</sup> winter	4	3
Highest daily average µg/m <sup>3</sup> summer	88	112
Highest daily average µg/m <sup>3</sup> winter	110	139
# Daily averages > 125 µg/m <sup>3</sup>	0	3
# Daily averages > 90 µg/m <sup>3</sup>	2	5
Average value µg/m <sup>3</sup> summer	7.2	12.0
Average value µg/m <sup>3</sup> winter	6.1	18.3

Annual mean concentrations of SO<sub>2</sub> for 4 EMEP stations and the two Norwegian stations Svanvik and Karpdalen are shown in Figure 4. The two Norwegian stations Svanvik and Karpdalen are most affected by the emissions from the smelter complex and clearly show enhanced values. Also the Russian EMEP station Jäniskoski have enhanced concentrations, although this station is located south of Nickel, and hence upwind of prevailing wind direction in winter. The Finnish stations and Karasjok have very low concentrations (background levels), these are all located several hundred kilometers away from Nickel and Zapolyarny.

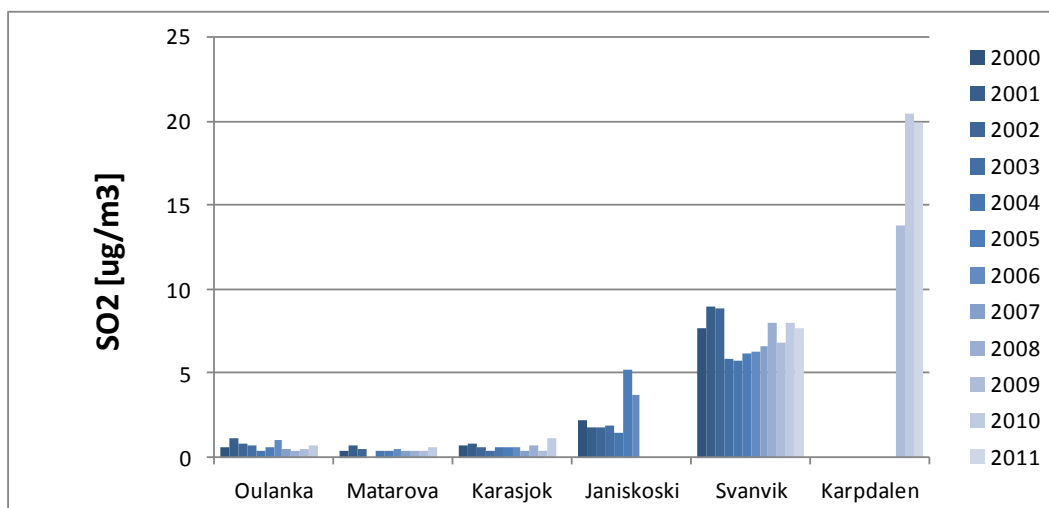


Figure 4: SO<sub>2</sub> in air, annual mean concentrations at 4 EMEP stations and the 2 Norwegian stations Svanvik and Karpdalen.

The station at Viksjøfjell, using passive samplers shows annual mean concentrations around 30 µg/m<sup>3</sup> for SO<sub>2</sub> (Berglen *et al.*, 2012). Viksjøfjell is located just north of Zapolyarny and is influenced by the emissions from the briquetting facility.

According to Russian reports (Murmansk oblast, 2011), the highest 20-minutes concentration of SO<sub>2</sub> in Nikel and Zapolyarny in 2011 were 6410 µg/m<sup>3</sup> and 3400 µg/m<sup>3</sup> respectively (data from January through August). The annual mean concentrations of SO<sub>2</sub> in Nikel have been approximately 65, 100 and 110 µg/m<sup>3</sup> for 2009, 2010 and 2011 respectively. In Zapolyarny the annual mean concentrations have been between 80 and 90 µg/m<sup>3</sup> during the last three years..

### Toxic elements in air

There are now sampling of toxic elements in air both at Svanvik (since autumn 2008) and Karpdalen (since autumn 2011). Prior to November 2011 the station at Svanvik did daily samples and only the filters exposed during easterly wind were analyzed. In autumn 2011 the sampling frequency was changed. Now the filters are exposed for one week and all filters are analyzed to get an annual mean value (Norwegian and EU/EEA target values are given as annual means, Table 1).

The winter mean values for toxic elements at Svanvik and Karpdalen are given in Table 5 (winter 2011/12, although there are only five valid months for Karpdalen). All these values are lower than the target values (given for one calendar year though, then these values cannot be compared directly, 20 ng/m<sup>3</sup> for Ni and 6 ng/m<sup>3</sup> for As).

*Table 5: Average values of elements found in air at Svanvik and in Karpdalen during winter 2011/2012 (Berglen et al., 2012).*

Station	From date	To date	Ni ng/m <sup>3</sup>	As ng/m <sup>3</sup>	Cu ng/m <sup>3</sup>	Co ng/m <sup>3</sup>
<b>Svanvik</b>	<b>01.10.2011</b>	<b>31.03.2012</b>	<b>4.51</b>	<b>1.92</b>	<b>5.03</b>	<b>0.18</b>
<b>Karpdalen</b>	<b>01.11.2011</b>	<b>31.03.2012</b>	<b>7.20</b>	<b>3.85</b>	<b>7.55</b>	<b>0.28</b>

FMI also does sampling of toxic elements in air at the EMEP station in Matarova. The annual mean value here is between 0,35 and 0,55 ng Ni /m<sup>3</sup> (Figure A.3 in Appendix A). This shows that Matarova is a background station (see Peltola and Sarala, 2012 for more information).

MUGMS also analyse samples from Nikel and Zapolyarny for toxic elements on a weekly basis. Concerning Ni, the maximum weekly mean value have been 700 ng/m<sup>3</sup> in Nikel and 950 ng/m<sup>3</sup> in Zapolyarny, respectively, for the period 2007 - 2012. This is not a violation of Russian air quality standard since the allowable norm for nickel is 1000 ng/m<sup>3</sup> (ch. 2.2). Concerning Cu, the maximum weekly mean value have been 960 ng/m<sup>3</sup> in Nikel and 600 ng/m<sup>3</sup> in Zapolyarny, respectively, for the period 2007 - 2012. Again this is not a violation of Russian air quality standard since the allowable norm for copper is 2000 ng/m<sup>3</sup>.

### **Toxic elements in precipitation**

Samples of precipitation are taken at Svanvik and analyzed for 10 different toxic elements (Pb, Cd, Zn, Ni, As, Cu, Co, Cr, V and Al)<sup>8</sup>. In the same manner there is sampling of precipitation at three different Finnish EMEP stations (Kevo, Matarova and Oulanka). Annual mean precipitation for Svanvik and the 3 Finnish EMEP stations is given in Figure 5. The northern areas are relatively dry with annual precipitation between 250 and 700 mm. At Svanvik the annual mean precipitation is about 300 - 400 mm. Most of this comes during the summer season (when also there is midnight sun and hence the vegetation can grow).

---

<sup>8</sup>Pb:lead, Cd: cadmium, Zn: zink, Ni: nickel, As: arsenic, Cu: copper, Co: cobalt, Cr: chromium, V: vanadium, Al: aluminium.



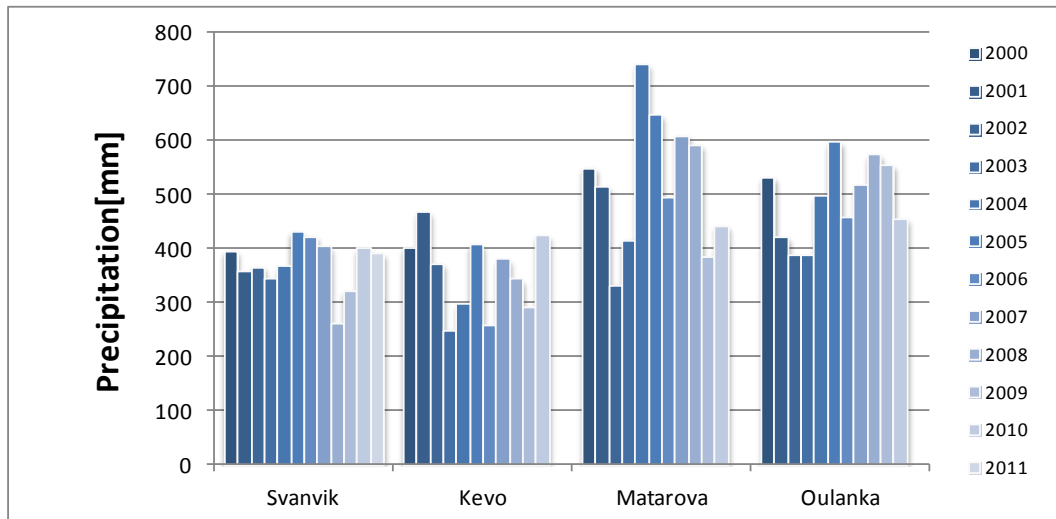
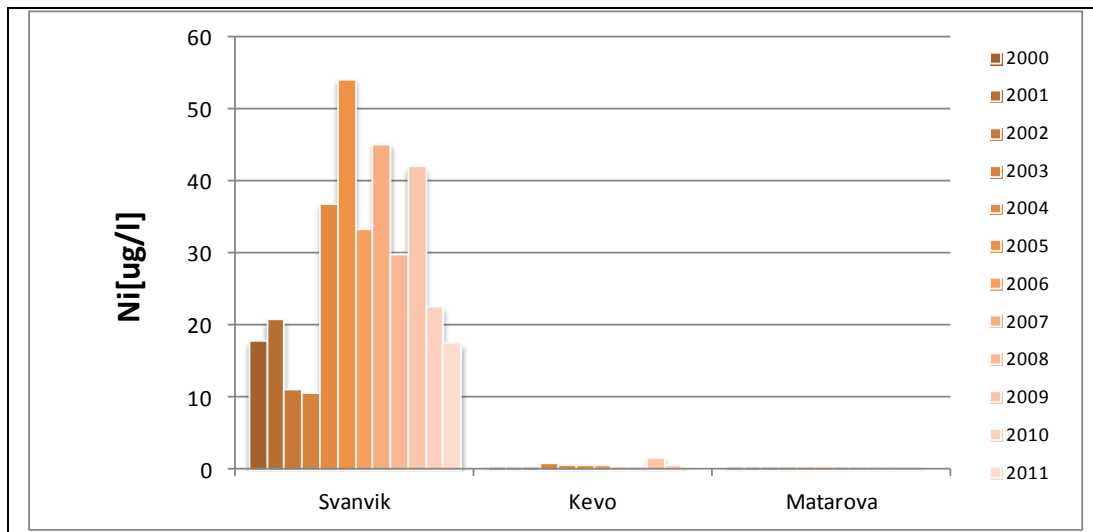


Figure 5: Annual mean precipitation for Svanvik and three Finnish EMEP stations. Unit: mm per year.

Ni, Cu, Co and As are considered trace metals from smelter activity. Results for these four elements are shown in Figure 6. There are two different ways of showing results for elements in precipitation, they may be shown as concentrations ( $\mu\text{g/l}$ ) or as deposition ( $\text{mg/m}^2$ ). Deposition is calculated as concentration  $\times$  amount of precipitation ( $\mu\text{g/litre} \times \text{litre/m}^2 = \text{mass/m}^2$ , given that 1 mm rain is equal to 1 litre per  $\text{m}^2$ ).



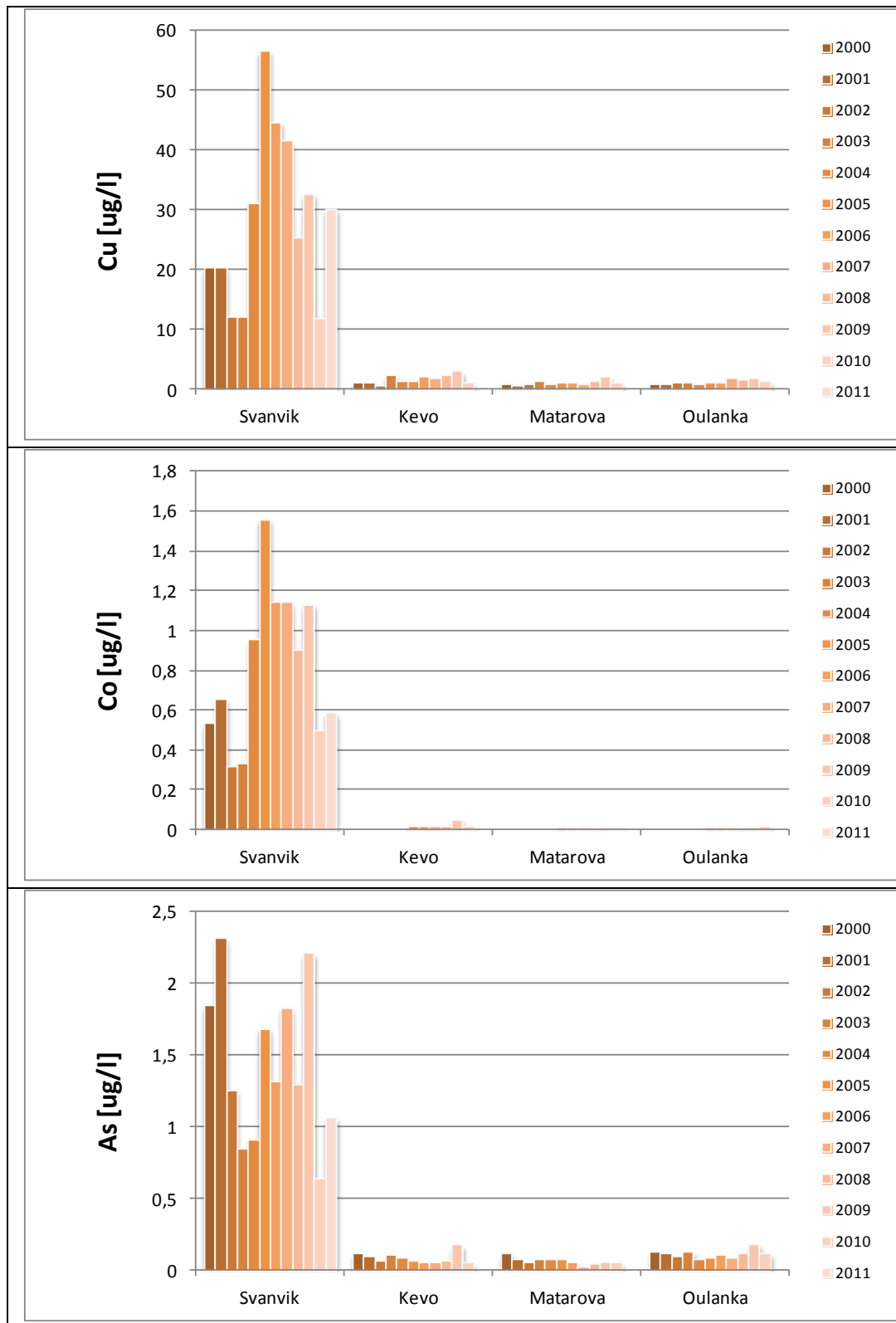


Figure 6: Annual mean concentrations of toxic elements in precipitation for Svanvik and three Finnish EMEP stations. Ni, Cu, Co and As are considered trace metals from smelter activity. Unit µg/l.

These results clearly shows that Svanvik is very much affected by elements emitted by the Russian smelter facilities. The other stations show low values of these elements. Also note that the concentrations of Ni, Cu and Co increased considerably in 2004 compared to the years prior to 2004. This pattern is also seen in other studies in the border areas, e.g. the lake water monitoring program at Jarfjord performed by NIVA (Schartau *et al.*, 2011). It should also be mentioned that the trends in concentrations found at Svanvik and in lakes at Jarfjord do not correspond with the emissions numbers given by the Kola MMC (Appendix A, Figure A.1). Our hypothesis is that there is information missing in the emission figures and that the numbers should be revised.

Results for Pb, Cd, Zn, Cr, V and Al are shown in Figure A.4, Appendix A. These results show that the concentrations at Svanvik are significantly higher than at the other stations, except for Zn.

## **2.6 Other topics, knowledge gaps**

### **Are there other components emitted from Russian smelter activity?**

There are officially reported emission numbers for SO<sub>2</sub>, Ni and Cu (ch. 2.1 and 0). However, it should be investigated whether there are emissions of other components from the smelters. As we know, there are emissions of Hg from Zapolyarny (Sigurd Rognerud, personal communication). We should also ask whether there are possible emissions of e.g. dioxins, PCB, PAH, trace metals other than the 10 analyzed at present, VOCs, H<sub>2</sub>S and others.

### **Do the plumes from Nikel and Zapolyarny reach populated areas like Kirkenes?**

As outlined here there are today two monitoring stations at Svanvik and Karpdalen at the Norwegian side of the border. These are located so that they capture the plumes coming from Nikel and Zapolyarny. However, there are not many people living at Svanvik and in Karpdalen/Jarfjord. One should also ask whether people living at Bjørnevatn, Sandnes, Hesseng and in Kirkenes may be exposed to the plume from Nikel (and from Zapolyarny). During the baseline survey in 1988-1991 there was sampling of SO<sub>2</sub> in Kirkenes on a daily basis (Hagen *et al.*, Sivertsen *et al.*, 1991). In summer 1990 the average concentration in Kirkenes was higher than in Karpdalen, while in winter 1990/91 the concentration in Karpdalen was highest of the two. Although the total emissions are lower now than during the 1980's and 1990's these numbers show that also Kirkenes may experience episodes with elevated concentrations.

During the baseline study there were episodes with very high concentrations at several stations in the border areas. A common feature about these episodes was

that most often there was a high pressure system to the east (in Soviet/Russia) and a low pressure system to the west or north west. This pattern will induce winds from the south or south east bringing the pollution into Norwegian territory. When the low pressure system passes from the west towards east, the wind will be more from the south and eventually from the south-west.

It is difficult to assess the probability for these episodes to happen, i.e. quantify the risk for exposure to the population in Kirkenes. But such episodes may occur, and additional measurements should be conducted (see knowledge gaps).

#### *Additional knowledge gaps*

- Today we analyze for total mass of heavy metals, there is a need to understand the form of these metals (e.g. ions) and salts such as nickel sulphate and nickel sulphite
- Concentration of PM at Svanvik and in Kirkenes/Hesseng
- Concentration of SO<sub>2</sub> in Kirkenes/Hesseng by use of passive samplers.
- Modelling of dispersion from Nikel and Zapolyarny smelters
- Concentration of Hg in air and precipitation (need special equipment)

### **3 Freshwater ecosystems**

The watercourses in the Russian, Norwegian and Finish border area comprise two contrasting types of system: the large-sized Inari-Pasvik watercourse, and numerous small-sized lakes and streams (Figure 7).

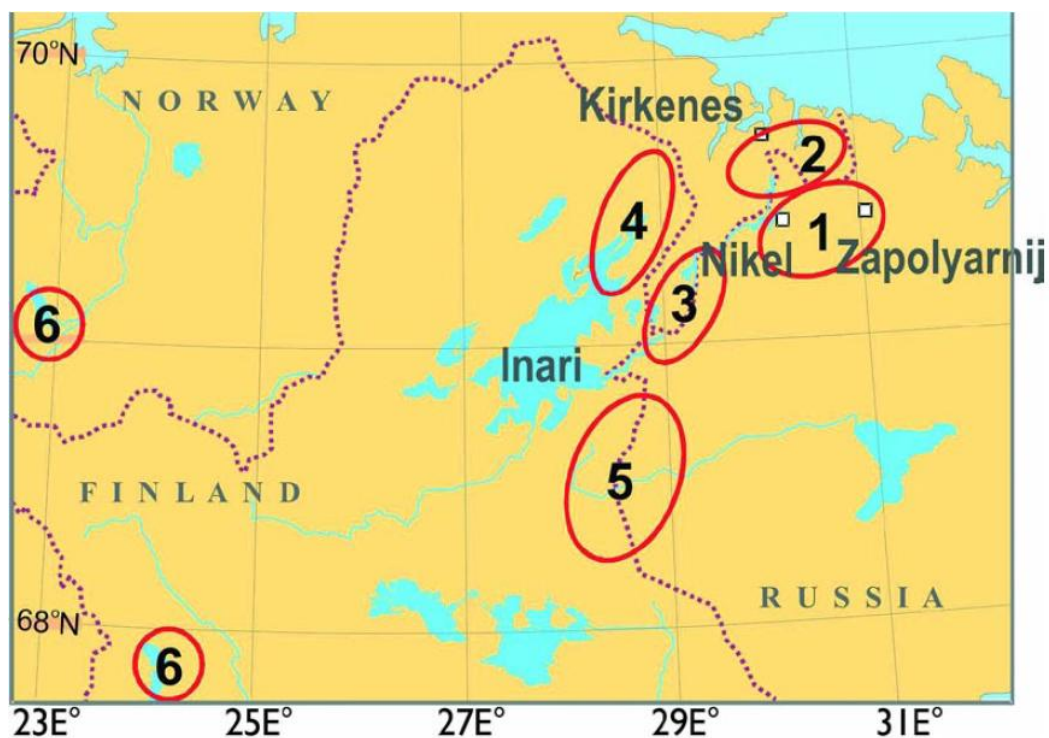


Figure 7. Map of the region showing the main areas, where small lakes and rivers have been investigated. 1 = Pechenganikel, 2 = Jarfjord + Sor-Varanger (= area between Jardfjord and Vatsari), 3 = upstream Pavik watercourse, 4 = Vatsari, 5 = Raja-Jooseppi, 6 = reference sites (Pallas in Finland and Stuorajavri in Norway).(From Stebel *et al.* 2007).

### 3.1 Pollution sources

Airborne long range transport is one of the sources for pollution in the area (Figure 7). However it is the local pollution that so far has got most attention.

The area is subject to severe anthropogenic influence from the Pechenganikel mining and metallurgical industry (Puro-Yahvanainen *et al.* 2011). Production at the smelters is associated with emissions of pollutants into the air (airborne pollutants) and runoff from the mining activities and the Nickel smelter complex (waste water from the mines, smelters, slime pits and tailing dumps). Wastewater is discharged directly into the lower part of the watercourse through Lake Kuetsjärvi. The Pasvik watercourse is impacted by a direct input of pollutants into the watercourses and by atmospheric pollutants, while the lakes and streams in the headwater areas of the Pasvik watercourse only receive atmospheric pollutants.

### 3.2 Lakes and rivers

Joint investigations from the early 1990's revealed numerous acidified and heavy metal polluted lakes in the border areas (e.g. Traaen 1987; Traaen *et al.*, 1991; Traaen *et al.*, 1992; Moiseenko *et al.*, 1994; Moiseenko *et al.* 1995, Moiseenko,

1996; Dauvalter and Rognerud, 2001; Nøst *et al.* 1991; 1997; Langeland 1993; Traaen and Rognerud 1996; Skotvold *et al.* 2001; Christensen *et al.* 2010; Puro-Yahvanainen *et al.* 2011; Skjelkvåle *et al.* 2013). Negative impacts on acid-sensitive biota have particularly been recorded in small-sized lakes and streams (Nøst *et al.* 1991; 1997; Langeland 1993; Kashulin *et al.* 1999). The impact is largest in Russian and Norwegian localities in the vicinity of the smelters, but effects are also seen on the Finnish side of the border (Lappalainen *et al.*, 1995; Yakovlev 1999; Mannio, 2001). The impacts are most obvious in the areas closest to the smelters, but surveys have shown impacts at large distances from the emission sources.

### 3.2.1 Surface water quality

#### Acidification

In 1986 studies of lakes in the eastern part of Finnmark indicated that the concentration of sulphate had more than doubled since 1966 (Traaen 1987). Further these studies showed that a high number of small mountain lakes in the area were chronically acid ( $\text{pH} < 5$ ). Even larger lakes in the area had little buffer capacity due to acidification. It was shown that small lakes at Jarfjordfjellet were so acidified that the fish populations died. Results from lake surveys in Finland, Norway and Sweden between the years 1986 to 1990 (Henriksen *et al.* 1992) showed that acidification, from high levels of sulphur in precipitation and deposition, were mainly limited to a distance of about 50 km from the large pollution sources in Russia.

Acidification of lakes were also reported on the Kola Peninsula around the industrial areas, but also in the northern and eastern part of Kola Peninsula. Monitoring of lakes in the Jarfjord area (Figure 8) confirms the results from the other lakes used for trend analysis. The small lakes in this area shown a stable and positive water chemical development since the monitoring began in 1987. Sulphate has shown a marked decline through the monitoring period.

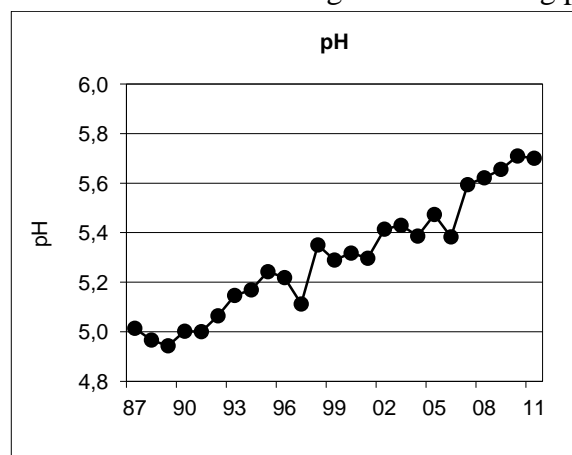


Figure 8. Trends in pH in six small lakes at Jarfjordfjellet 1987 to 2010. (Median values). Skjelkvåle *et al.* 2013.

Skjelkvåle *et al.* 2013 selected 19 Norwegian and 10 Russian lakes with sufficient data to perform a statistical trend analysis. The results showed that all the Norwegian lakes had a significant decreasing trends in sulphate for the monitoring period from 1986. Only one of the 10 Russian lakes with sufficient data for trend analysis, showed a significant decreasing trend. The reason for this may be larger year-to-year variation in chemistry, combined with fewer data points and shorter series than the Norwegian lakes (Skjelkvåle *et al.* 2013).

### **Cu and Ni in lake water**

The levels of trace metals in surface water is mainly dependent upon geological input (trace metal content of bedrock) and atmospheric input (long range and local sources).

Detailed studies of metals in lakes in eastern Finnmark (Traaen and Rognerud 1996) showed that the geographical distribution of elevated nickel (Ni) and copper (Cu) concentrations largely followed the same pattern as sulfate, but the concentrations of Ni and Cu declined more rapidly from the source. Concentrations were estimated to be at background levels about 50 km from the smelter.

Six small lakes in the Jarfjordfjell area have since 1990 been monitored for metals on a yearly basis. The concentrations of Ni and Cu in surface water showed no change between 1990 and 2003. Results of the investigations of water and sediments in 1995 (Traaen and Rognerud 1996) showed that the concentration of metals in lake sediments in the area had increased in the 90s, and that enrichment of Ni and Cu in the catchments continued. Leaching of heavy metals from the catchment areas was significantly lower than the deposition inputs (for Ni approx 50 %, for Cu approx 10 % of the deposition input).

The smelter in Nikel has in recent years used a local ore with a lower sulfur content than the ore from Norilsk that was previously used. This has however not reduced the metal emissions. At the air monitoring station in Svanvik it has been registered higher wet deposition of Cu and Ni after 2004 than before (Berglen *et al.*, 2011). The same pattern is evident for concentrations of Cu and Ni in the lakes on Jarfjord Mountain. Average concentration of Cu in the lakes is now (2010-2012) the highest measured since the monitoring started.

Levels of Cu and Ni in lakes from the border region are elevated compared to areas in Norway not affected by point sources. The median concentration value for Ni in 297 lakes monitored in Norway in the period 2004 - 2006 was 0.28 µg/l (Skjelkvåle *et al.* 2008). Skjelkvåle *et al.* (2013) collected samples from 25 Russian lakes and 29 Norwegian lakes. The median Ni concentration in water from the Russian and Norwegian lakes were 39 µg/l, and 6.4 µg/l respectively. For Cu the median concentration values were 0.31 µg/l for the 297 Norwegian

lakes (Skjelkvåle *et al.* 2008), and 5.8  $\mu\text{g/l}$  and 2.4  $\mu\text{g/l}$  for the Russian and Norwegian lakes in this survey, respectively.

The Cu and Ni concentrations in lakes in the border area show that there is clear gradients in concentration levels, with decreasing levels away from the point sources (Figure 9 and Figure 10). This is in line with earlier investigations on surface water (Skjelkvåle *et al.* 2007), lake sediments (Rognerud *et al.* 2013), terrestrial moss (Steinnes *et al.* 2001), and soil humus layer (Nygård 2000). The maps show that at a distance about 40-50 km away from the smelters the lakes have concentrations of Cu and Ni that are more comparable with expected values in lakes not influenced by air pollution or other pollution sources (Figure 9 and Figure 10).

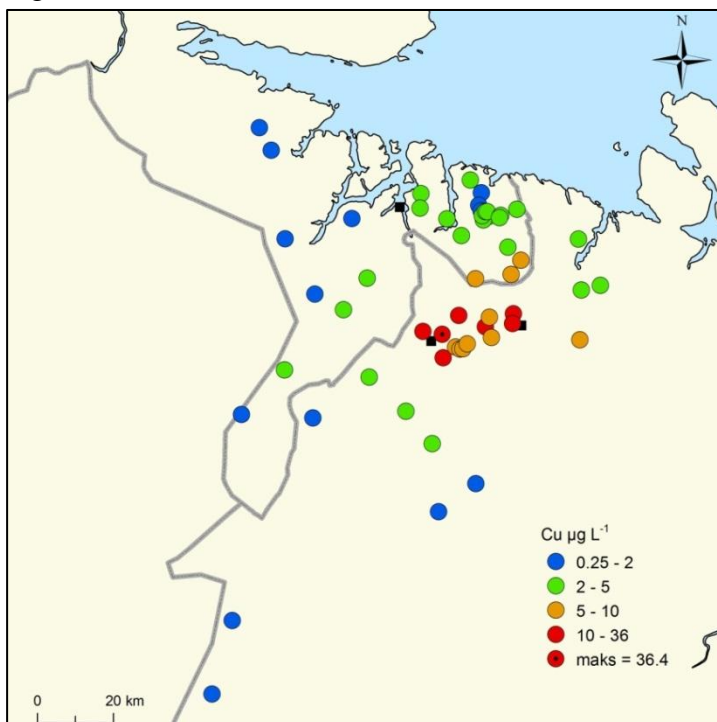


Figure 9. Levels of Cu in water from border lakes , autumn 2010 (From Skjelkvåle *et al.* 2013).



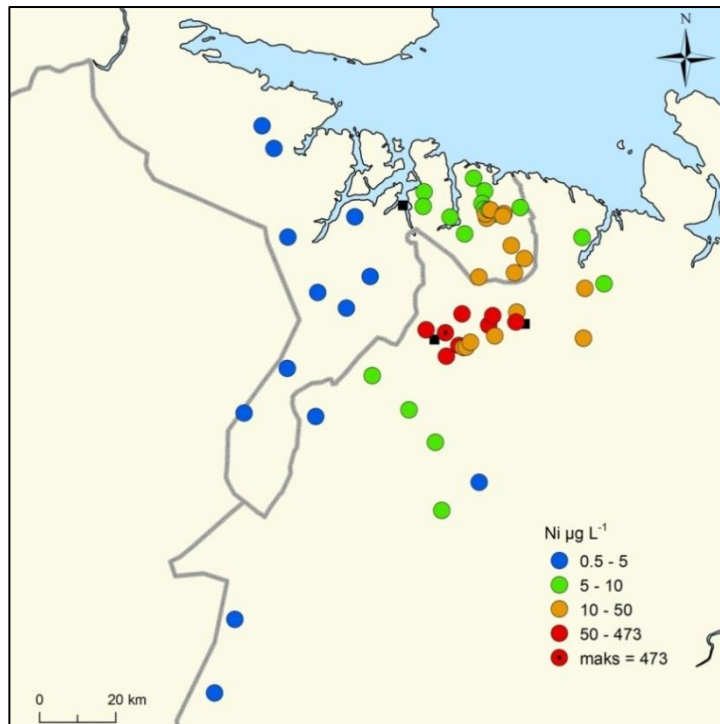
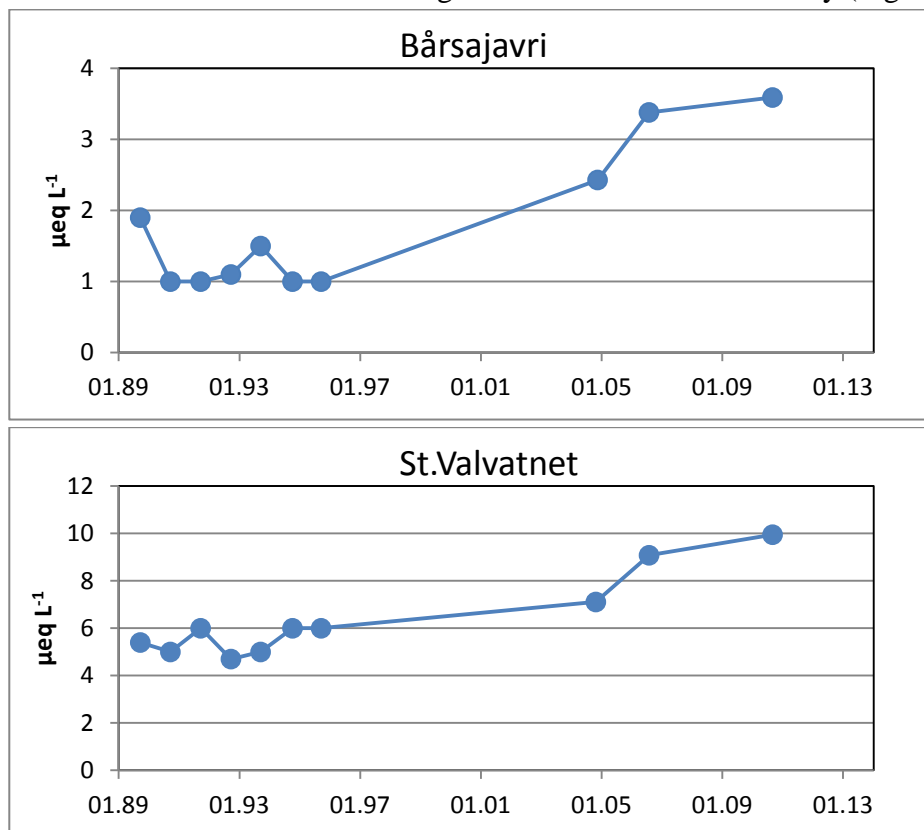


Figure 10. Levels of Ni in water from border lakes, autumn 2010 (From Skjelkvåle et al. 2013).

There are relatively few lakes with good long-term data for trends in Cu and Ni. However, in 3 Norwegian lakes the data set is very good and the data clearly show that the levels of Ni are increasing from 2005 and towards today (Figure 11).



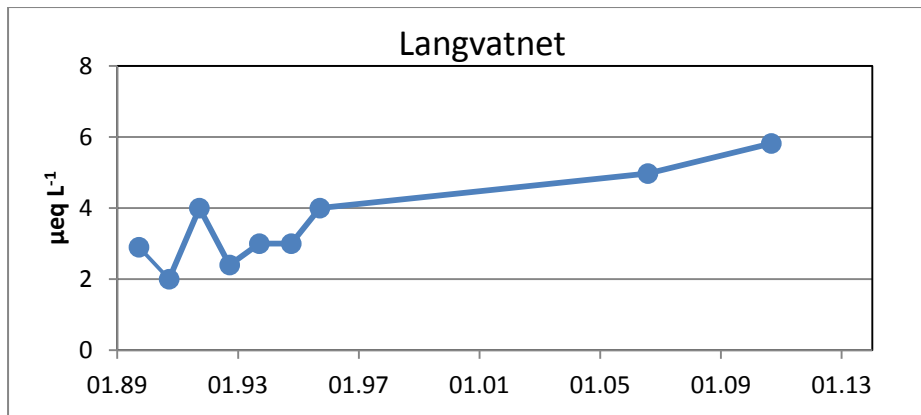


Figure 11. Trends in Ni in 3 Norwegian lakes (From Skjelkvåle *et al* 2013).

Also in a yearly monitoring of metals in water from six small lakes at Jarfjordfjellet there was an increasing trend in concentrations of Ni between 2004 and 2005 (Skjelkvåle *et al.* 2013) (Figure 12). The levels of Ni has been high since 2004.

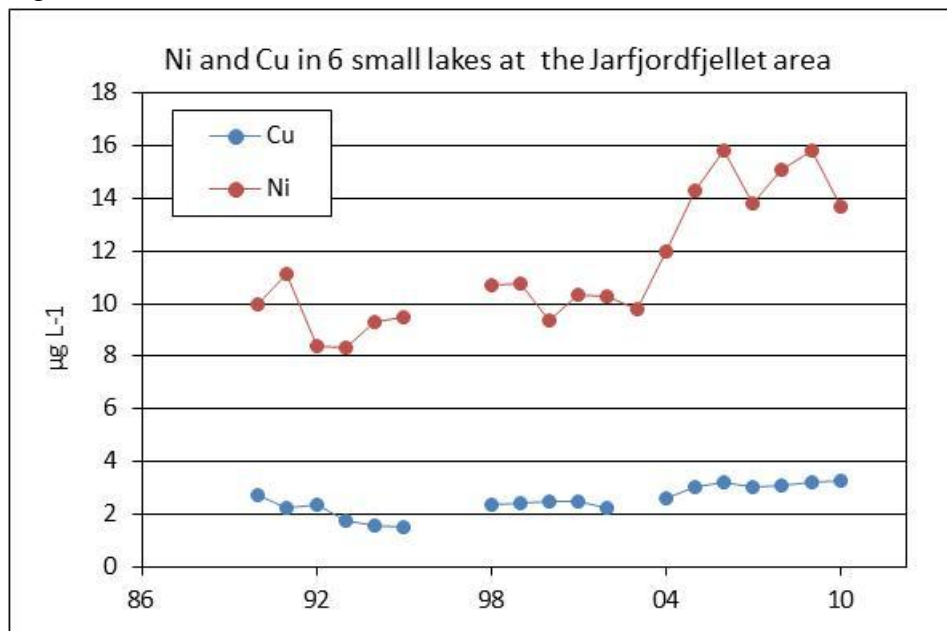


Figure 12. Yearly average mean for Cu and Ni in water from 6 small lakes at the Jarfjordfjellet area (From Skjelkvåle *et al.* 2013).

### Other metals in surface water

The water in lakes from the border region is insignificantly polluted with regard to Zn, Pb, Co, Cd, Cr and As, according to the Norwegian classification system (Skjelkvåle *et al.* 2013). However, there is indications of decreasing trends in concentrations away from the smelter, indicating that the smelters may be a source also for these metals.

### 3.2.2 Lake sediment

Sediment samples from the small (and several larger) lakes provide a good opportunity to determine the dispersal area of emissions from the smelters.

The regional lake surveys from 2004 - 2006 also showed a sharp increase in Ni and Cu in the upper part of the sediment profile (Christensen *et al.* 2008; Rognerud *et al.* 2008), and this has been confirmed again in a recent survey of lake sediment samples (Rognerud *et al.* 2013). Rognerud *et al.* (2013) analysed trace element concentrations in surface sediments (0 - 0.5 cm) and pre-industrial sediments (Figure 13) from 45 lakes in the region to uncover spatial deposition patterns and contamination factors for sediment.

Rognerud *et al.* 2013 showed that the concentrations of Cu and Ni were high (> 200 µg/g) to extremely high (>1 mg/g, 6 lakes). Elevated concentrations were also found for Pb, Co, Hg, As and Cd. The contamination factors (Cf) (ratio between concentrations of trace-elements in surface and reference sediments) showed that surface sediments close to the emission sources were heavily polluted by Ni and Cu, with a mean contamination factor of 63 and 50, respectively, and in decreasing order from 18.8 to 2.4 for Pb, Co, Hg, Cd, As, Cr and Zn.

Rognerud *et al.* 2013 found that the highest concentrations of metals in lake sediments were found up to 20 km from the smelter, but the concentrations decreased exponentially with distance from the smelter (Figure 14). The prevailing south-westerly winds carry the emission plume mainly in a north-easterly and southerly direction, and therefore bottom sediments in lakes located 50 km and more to the south of Nikel are only slightly polluted. Increasing Ni, Cu, As and Hg concentrations from sub-surface to surface sediments were found for lakes at intermediate distances (20-60 km). This may reflect recent changes in atmospheric depositions, as shown in nearby Norwegian areas. The results described by Rognerud *et al.* 2013 is also supported by other studies in the area (Dauvalter 1994; Rognerud *et al.* 1998, Rognerud and Fjeld 2001, Stebel *et al.* 2007, Kashulin *et al.* 2012).

The smelter complex at Nikel and Zapoljarnij, Kola Peninsula, is one the most important point sources for pollution of metals and sulfur dioxide for this part of the arctic/sub-arctic region. An escalation in mercury emission from the smelters is especially worrisome in the light of the general increase of mercury pollution in the vulnerable arctic environment - as emphasized in the recent mercury assessment report of AMAP (2011).

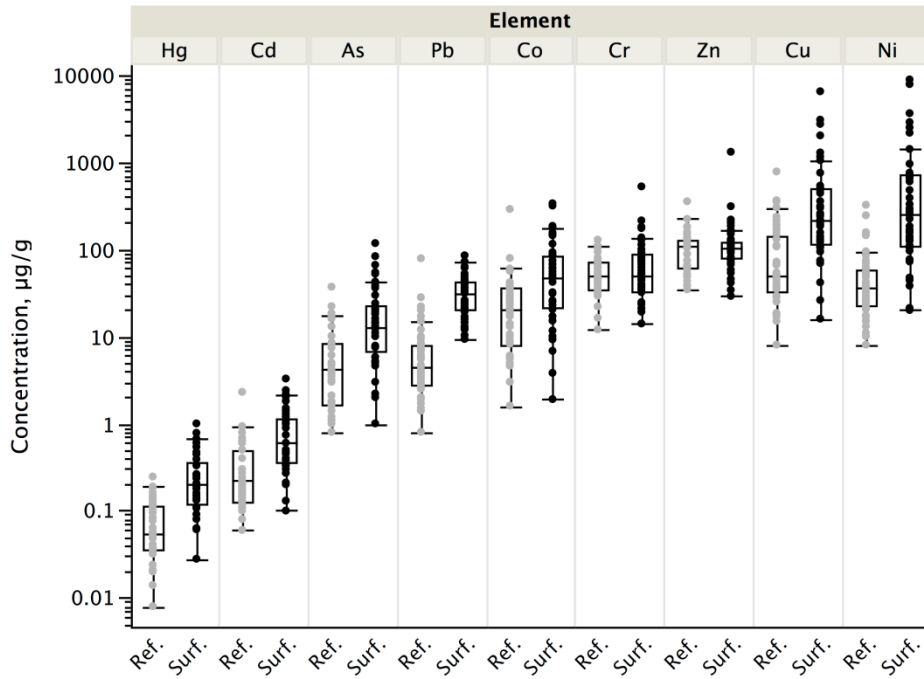


Figure 13. Box-and-whisker plots showing metal concentrations in surface (0–0.5 cm) and reference sediments (30±5 cm). The median (50th percentile) is marked as a horizontal line across the interquartile box (25th and 75th percentiles), and the 10th and 90th percentiles are shown as horizontal lines outside the box ( $n = 45$ ). From Rognerud et al. (2013).

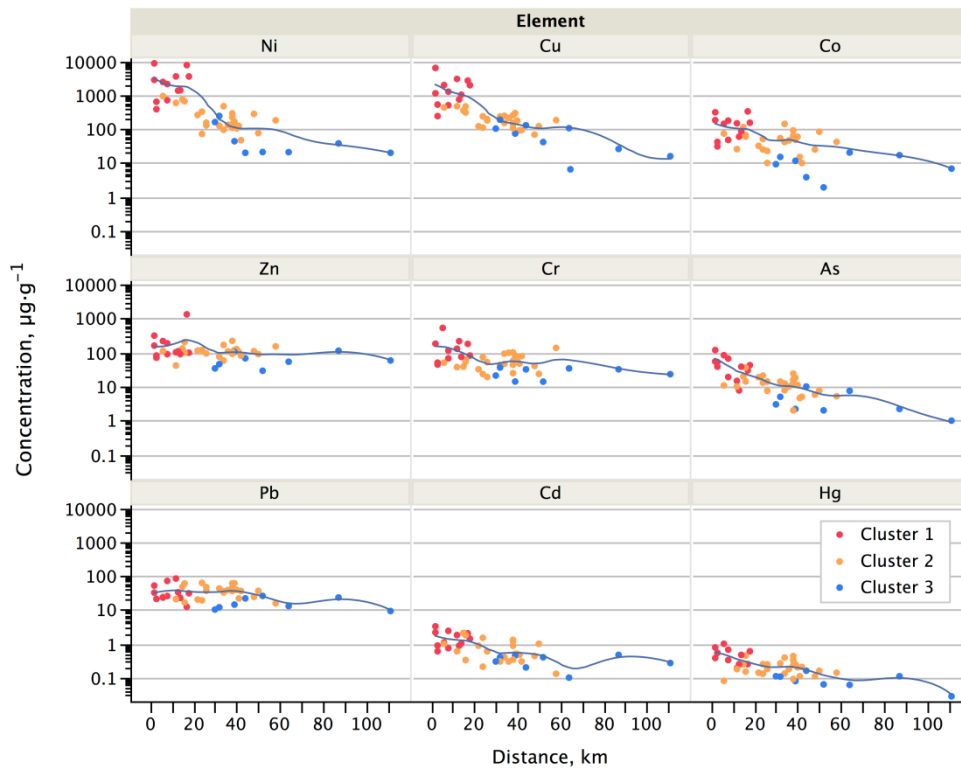


Figure 14. Trace-element concentrations in surface sediments (0–0.5 cm) in the study lakes ( $n = 45$ ) and their distance from the Nikel smelter. The

*lakes are grouped according to a cluster analysis – red dots 0 – 20 km from smelters, orange dots 20 – 60 km from smelter and blue dots more than 60 km from smelters. From Rognerud et al. (2013).*

### **Arctic assessment and monitoring program (AMAP)**

An important monitoring program for the Norwegian Arctic is the Arctic Monitoring and Assessment Program (AMAP). The AMAP region in Norway is defined as the area north of the Polar circle. In the latest AMAP lake survey (Christensen *et al.* 2008) sediment from 123 lakes were sampled, of which 115 are located on the mainland of Norway and 8 on Svalbard. Sediment from 122 lakes were analysed for metals, while PAHs and POPs were investigated in sediments from a subset of the lakes. Fish samples were collected from 8 lakes (1 in Nordland, 1 in Troms, 2 in Finnmark, 2 on Bjørnøya and 2 on Svalbard).

The AMAP study showed very interesting results for Ni, Cu and Hg for the lakes the border region. The highest concentrations of Ni in surface sediments were recorded in the lakes in eastern Finnmark on the Sør-Varanger Peninsula (Figure 15). The concentrations in the 14 lakes in this area ranged from 61.2 - 456.1 µg/g dw, with an average concentration of 143.4 µg/g dw. The median value for all the lakes in this study was 30.3 µg/g dw. The levels of Ni is also elevated in the sediments from Lake Ellasjøen on Bjørnøya. In a recent study from this lake, Evenset *et al.* (2007a) studied time trends of heavy metal in the sediment. They indicated that the recorded levels of Ni in the lake had been affected by emissions from the smelters in Northwest Russia (Nikel and Zapolyarny) since the time trends in the concentration of Ni follow the same trends as the emissions from the smelter.

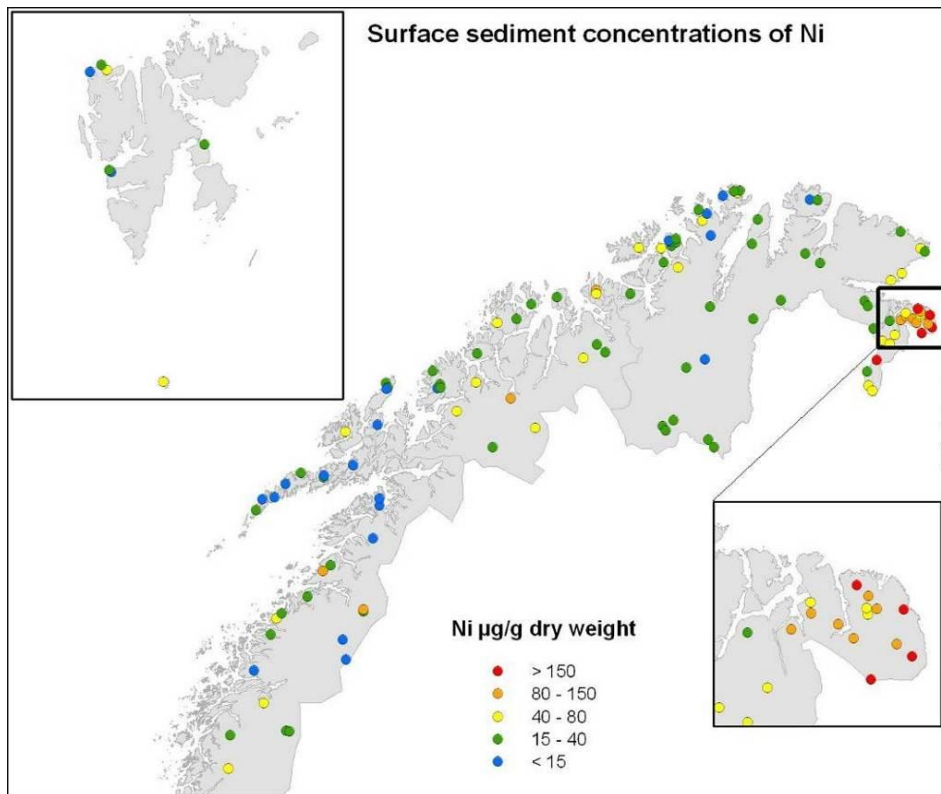


Figure 15. Concentrations ( $\mu\text{g/g dw}$ ) of nickel (Ni) in surface sediments from lakes on the mainland of Northern Norway and on Svalbard (Christensen et al. 2008).

Most of the lakes in this study can be categorised as slightly to moderately enriched with Ni (Figure 16). However many of the lakes in the eastern part of Finnmark County are categorised as severely to extremely enriched. The plot of changes in concentrations in recent time, indicated by the difference between surface sediment (0 - 0.5 cm) and subsurface sediment (0.5 - 1.0 cm), reveals a severe increase in the concentrations of Ni in sediments in the eastern part of Finnmark (Figure 16).

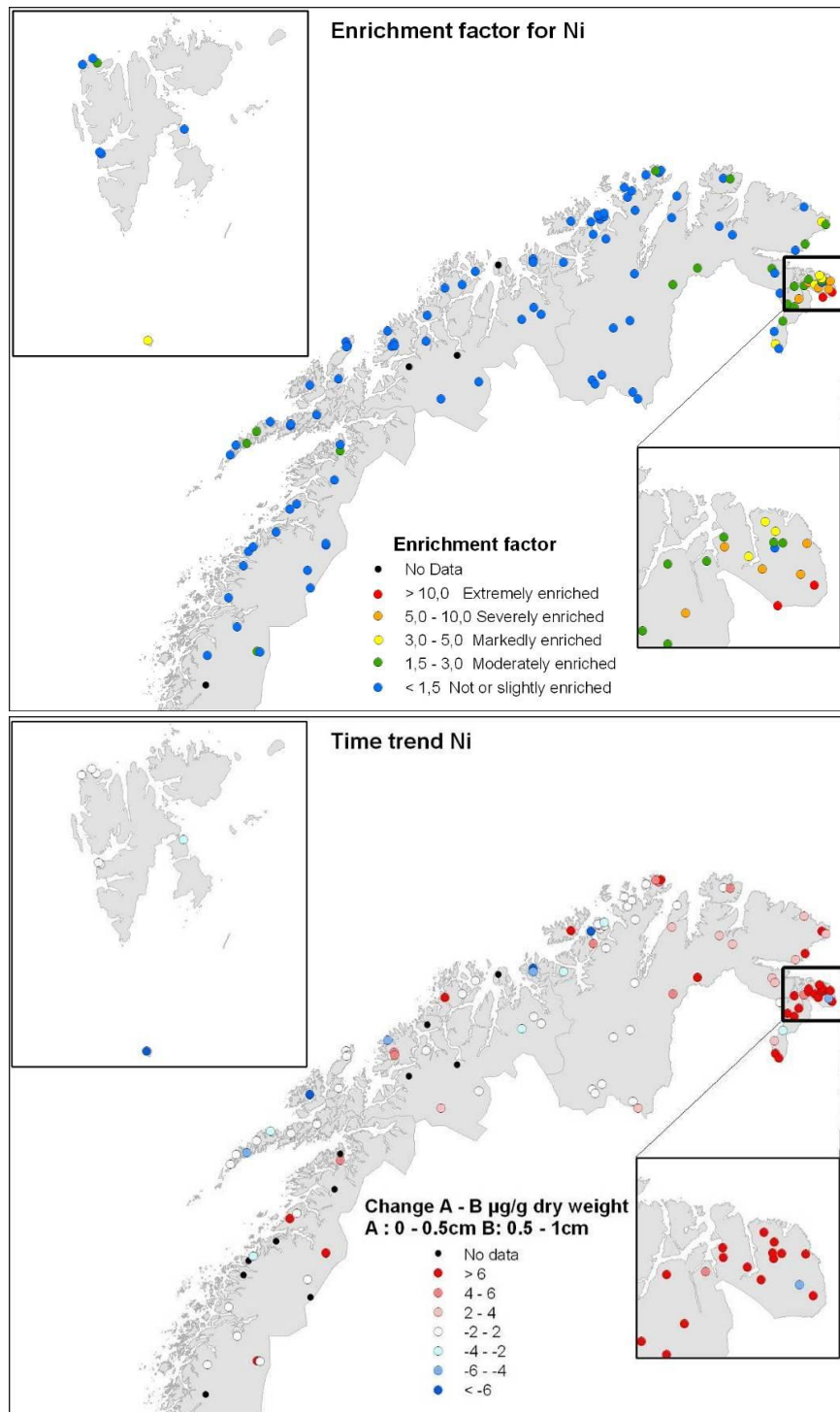


Figure 16. Enrichment factor for nickel (Ni) in surface sediments (upper figure) and differences in concentrations ( $\mu\text{g/g}$  dw) of Ni between surface layer (0 - 0.5 cm) and subsurface layer (0.5 - 1.0 cm) (lower figure) (Christensen et al. 2008).

In the AMAP study the median measured concentrations of Cu in surface sediment for all the lakes was 46.2  $\mu\text{g/g dw}$ . However higher levels were observed in the coastal lakes in Troms County and especially in eastern Finnmark (levels up to 346  $\mu\text{g/g dw}$ ) (Figure 17).

Almost all the lakes in the region are categorised as slightly enriched with Cu, except some of the lakes in eastern Finnmark which are categorised as markedly to extremely enriched (Figure 18). The plot of changes in concentrations in recent time, indicated by the difference between surface sediment (0 - 0.5 cm) and subsurface sediment (0.5 - 1.0 cm), reveals that there have been small changes in the Cu concentrations during the last decades (Figure 18). However, there has been a quite high increase in the levels of Cu in the sediments in the lakes in eastern Finnmark.

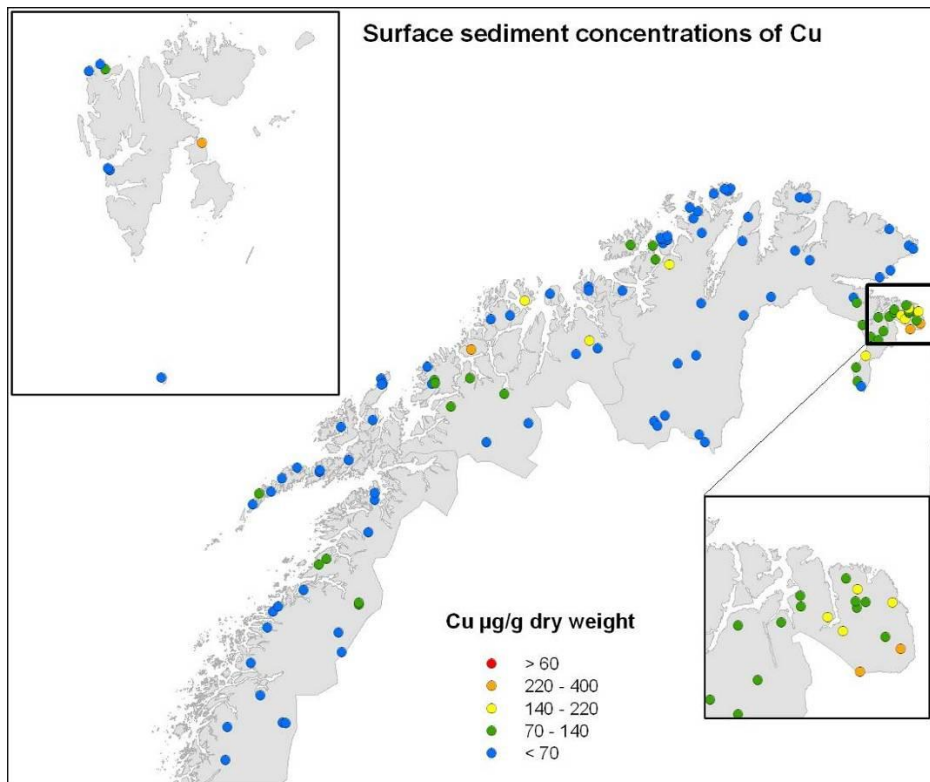


Figure 17. Concentrations ( $\mu\text{g/g dw}$ ) of copper (Cu) in surface sediments from lakes on the mainland of Northern Norway and on Svalbard (Christensen et al. 2008).



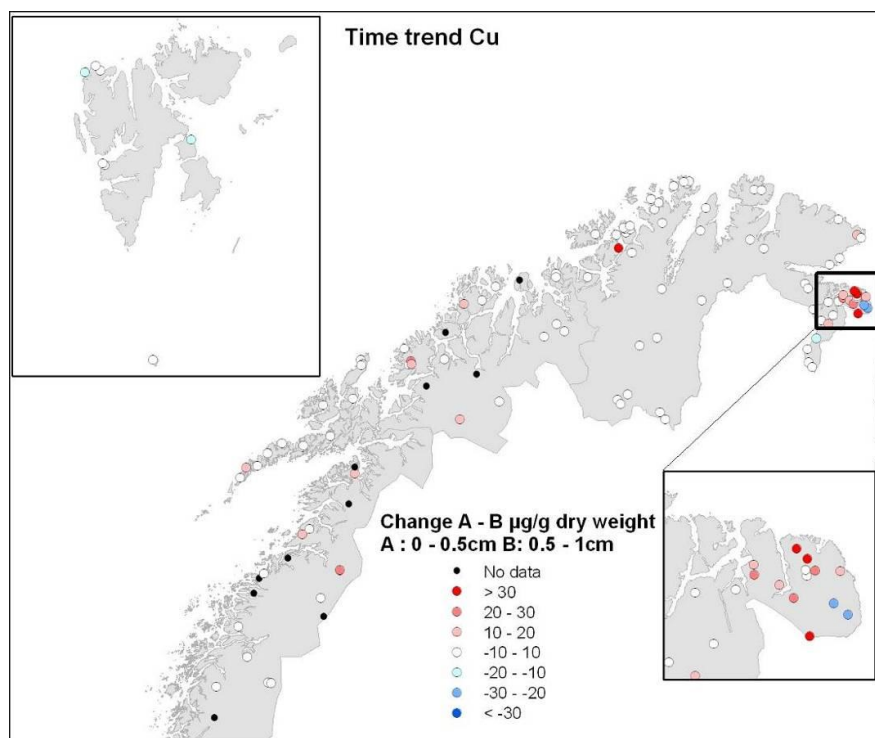


Figure 18. Differences in concentrations ( $\mu\text{g/g dw}$ ) of Cu between surface layer (0 - 0.5 cm) and subsurface layer (0.5 - 1.0 cm) (lower figure) (Christensen et al. 2008).

Generally the highest concentration of mercury (Hg) in the sediment surface layer (0-0.5 cm) was recorded in the lakes along the coast. In addition, elevated levels were recorded in lakes in the eastern part of Finnmark County (Sør-Varanger municipality). Enrichment factors for Hg indicate that most of the lakes are moderately to markedly enriched with mercury (Figure 19). The highest enrichment factors were observed in some of the lakes in eastern Finnmark County (severely to extremely enriched).

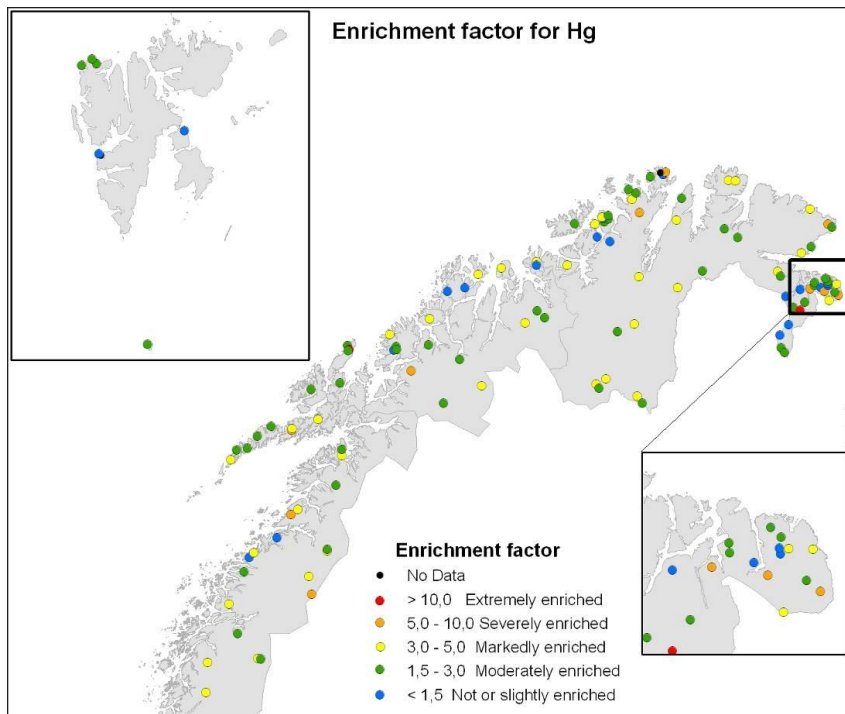


Figure 19. Enrichment factor for mercury (Hg) in surface sediment in lakes on the mainland of Northern Norway and on Svalbard (Christensen *et al.* 2008).

### Persistent organic pollutants (POPs) in sediment

There are few studies of levels of persistent organic pollutants (POPs) in lakes from eastern Finnmark. However, some POPs were included in the AMAP lake survey (Christensen *et al.* 2008).

**Polychlorinated biphenyls (PCBs):** The levels of PCBs in lake sediment were generally low, with a few notable exceptions. In the Pasvik-region levels were low to moderate. Other studies from the Pasvik watercourse have shown higher levels of PCB in sediments downstream the Russian smelter compared to the levels upstream (Christensen *et al.* 2007a, Christensen *et al.* 2007b).

**Polybrominated diphenyl ethers (PBDEs):** Generally PBDE-levels were low in sediment from the lakes in Nordland (average 84 ng/kg dw), higher in lakes from Troms (average 96 ng/g dw) and highest in lakes from Svalbard and Finnmark (average 817 and 881 ng/kg dw, respectively). The levels in some of the lakes, especially in Finnmark (up to 9 625 ng/kg dw) are high compared to levels found in much more industrialised areas. The reason for the elevated levels in the Finnmark lakes is unknown.

**Dioxins;** Dioxins and furans have been included in a few studies in the area (Schlabach and Skotvold 1996; Skotvold *et al.* 1997; Enge *et al.* 2003; Christensen *et al.* 2007; Christensen *et al.* 2011). The main studies have been

carried out close to Kirkenes, due to past emissions of dioxins from Sydvaranger Pellet industry.

In the AMAP study only sediment from 12 lakes (1 in Nordland, 1 in Troms and 10 in Finnmark) were analysed for dioxins. The levels were generally low, ranging from 1.0 ng TEQ/kg dw to 33.5 ng TEQ/kg dw. However, high concentrations of dioxins have been reported from other lakes located in the dominant wind-direction from this industrial complex (Schlabach & Skotvold 1996).

### 3.2.3 *Fish in lakes and rivers*

#### **Effects of acidification**

Several lakes in the Jarfjord Mountains have suffered from serious acidification due to SO<sub>2</sub> emissions from the smelters. This was especially the case in smaller lakes located at a relatively high altitude and with a geology associated with a low resistance to acidic inputs. In 2004 – 2006 a number of studies were performed on the response of populations of brown trout and Arctic char to the recent improvement in water quality in four acid-sensitive lakes in the Jarfjord Mountains in eastern Finnmark (Hestehagen *et al.* 2007). The allopatric population of brown trout in Lake Otervatn recovered almost completely in recent years. There has also been an increase in the catches of brown trout in two other lakes, which also contain Arctic charr. The age-frequency distribution of brown trout in the lakes indicate that a higher number of age groups have been present in recent years, and the recruitment rate has also increased. In contrast, the Arctic charr populations have decreased in abundance in recent years.

#### **Contaminants and dioxin-levels**

In 1994 it was discovered that Sydvaranger Pellet industry had high emissions of dioxins (PCDD/PCDF). In 1995 sediment and fish from some of the lakes close to the factory were analysed for dioxins (Schlabach og Skotvold 1996). The results from the study showed high levels of dioxins in fish from lakes close to the factory. Based upon the elevated concentrations of dioxins Norwegian Food Safe Control Authority (NFSA) issued dietary advices that discouraged fish consumption from lakes close to Kirkenes. In two following investigations (2003 and 2009) elevated dioxin concentrations in fish were measured, but levels were decreasing (Figure 20) and in 2009 levels in all lakes were below the level for safe human consumption (Schlabach og Skotvold 1997, Enge *et al.* 2003, Christensen *et al.* 2009). Despite this the dietary advice has not been revoked.

No studies has been carried out to investigate levels of contaminants (metal, mercury and POPs) in fish from lakes and rivers outside the Pasvik watercourse.

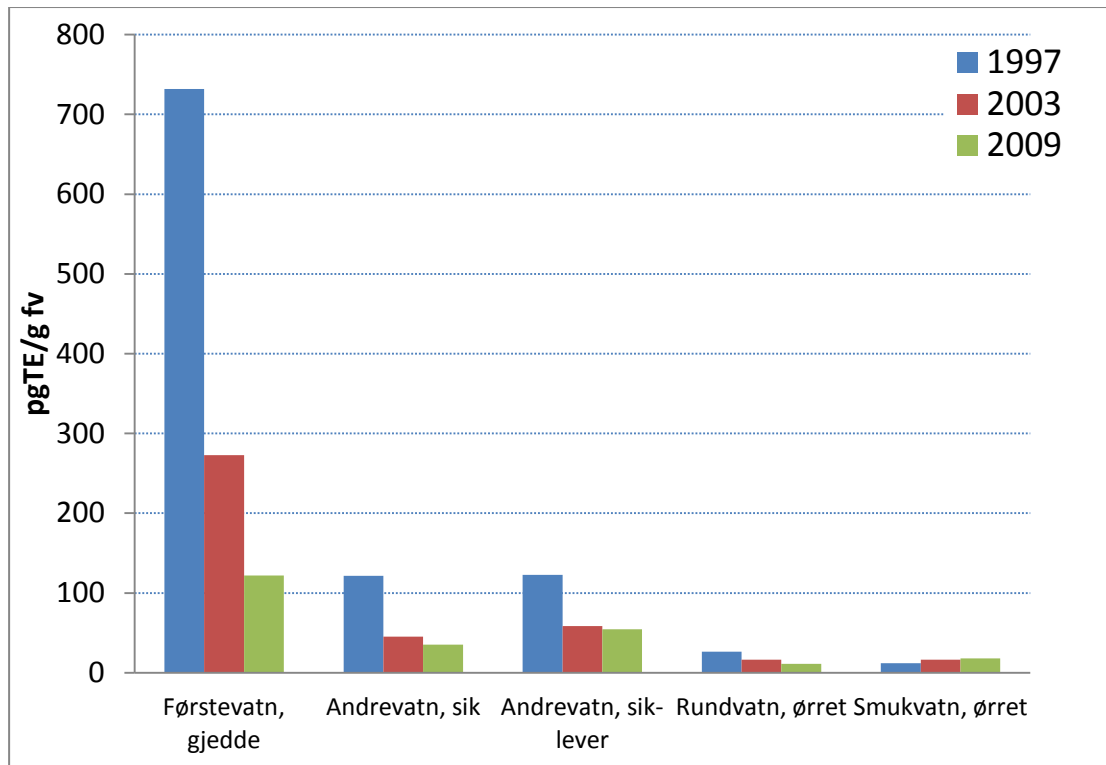


Figure 20. Levels (pg TE/g vv) of dioxins (PCDD/PCDF) in different fish species from lakes close to Kirkenes from 1997, 2003 and 2009. WF = White fish (From Christensen et al. 2009).



Figure 21. Whitefish from Førstevatn close to Kirkenes.

### 3.3 Pasvik watercourse

The Inari-Pasvik watershed is the main freshwater system in the region, covering an area of approximately 1250 km<sup>2</sup>. It has a catchment area of 18 404 km<sup>2</sup>, of which approximately 70 % belongs to Finland, 25 % to Russia and 5 % to Norway. The watercourse has important environmental qualities and rich natural resources, constituting a subarctic system with high biodiversity and production of fish and other aquatic organisms.

The Pasvik watercourse is located in the vicinity of the Pechenganikel smelters, which release complex mixtures of pollutants into the environment (Stebel *et al.* 2007; Puro-Yahvanainen *et al.* 2011). The pollutants enter the Pasvik watercourse either directly from the industrial activities associated with the smelters via runoff (waste water from the mines, smelters, slime pits and tailing dumps), or from the air (dry and wet deposition).

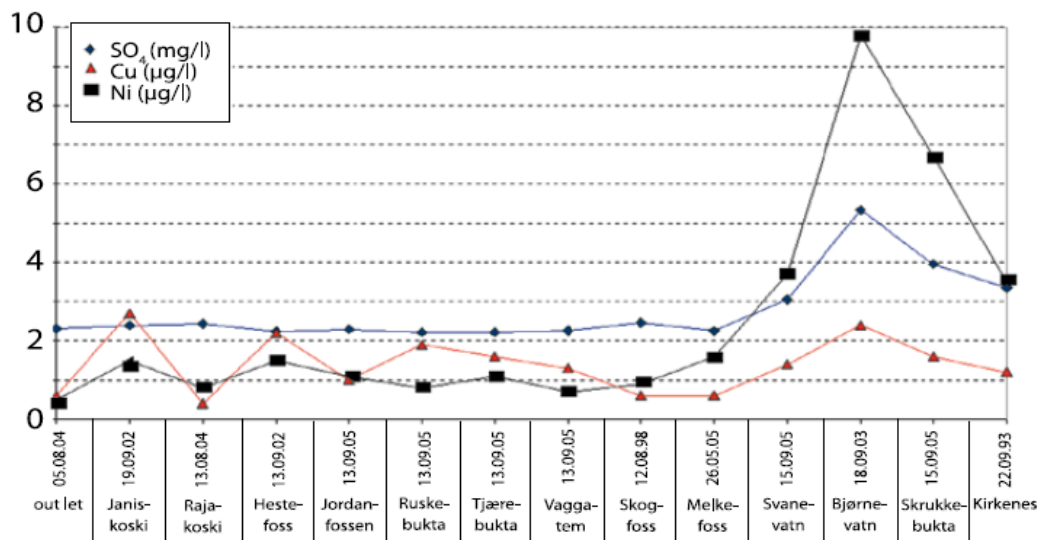


Figure 22. Map showing the locations of the main monitoring stations in the Pasvik watercourse. Lake Inari in Finland, Rajakoski (R), Hestefoss (N), Ruskebukta (N) and Vaggatem (N) are located upstream the smelter.

*Kolosjoki (R), Lake Kuetsjarvi (R), Bjørnvatn (N) and Boris Gleb (R) are located downstream the smelters (From Stebel et al 2007).*

### 3.3.1 Water quality

Monitoring results from the Pasvik programme (2000 – 2009, Stebel *et al.* 2007; Puro-Yahvanainen *et al.* 2011) confirm that the river and water system of the basin still is affected by pollutants originating from sewage, as well as from Pechenganickel's emissions transferred by air. Cu, Ni and sulphates (Figure 23) are the main pollution components. The highest levels were found close to the smelters.



*Figure 23. Distribution of Cu, Ni (µg/l) and sulphate (mg/l) concentrations in the Pasvik watercourse (From Stebel et al. 2007).*

Metals, especially copper and nickel (Figure 24), together with sulphates serve as indicators of the smelter's negative impact and distribution of loading in the river basin. Loading coming from the Kolosjoki River polluted with the smelter's discharge eventually pollute the water of River Pasvik. Pollutant concentrations in the mouth cross-sections of the River Pasvik, although considerably lower than those in the polluted water sources, are still some-what higher than those in the background cross-section of the Kolosjoki River and at the stations upstream in the Pasvik watercourse.

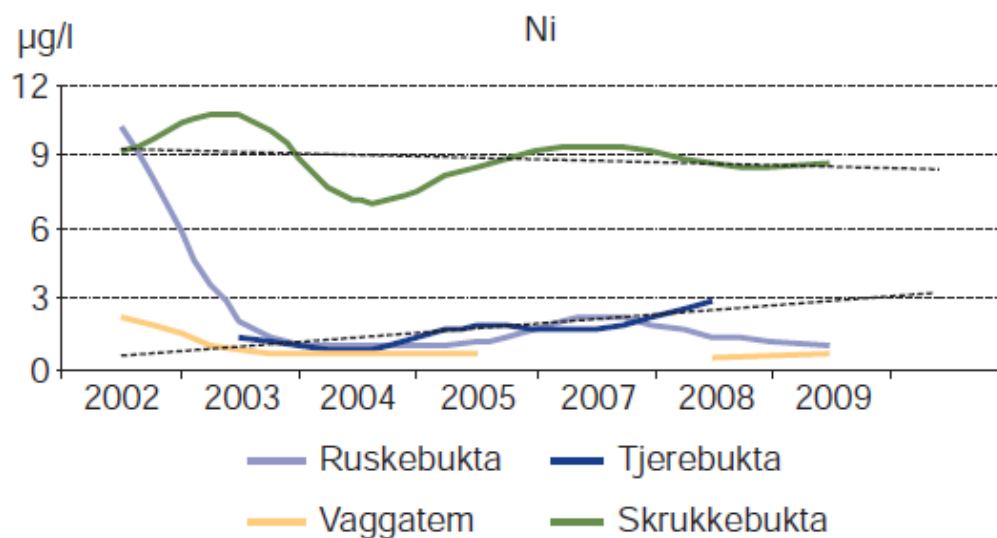


Figure 24. Levels and time trends for nickel (Ni) in water samples from different part of the Pasvik Watercourse (From Puro-Yahvanainen *et al.* 2011).

Even though Kola GMK report that they reduce sewage discharges into surface waters every year, there has been no decrease in the concentrations of Cu and Ni in water in the Pasvik watercourse during the past 9 years (Puro-Yahvanainen *et al.* 2011).

### 3.3.2 Sediment

In surface sediments the concentrations of most of the metals, PAHs and POPs were highest downstream (Lake Kuetsjarvi) from the Pechenganikel smelters (Figure 25). The concentrations upstream from Lake Kuetsjarvi were considerably lower than those downstream (Skrukkebukta and Bjørnevatn) (Figure 25). However, this was not the case for Pb and Hg. The reason for this is not clear, but it seems that long range transport of Hg is important in the area. The Ni concentrations in surface sediment in Lake Kuetsjarvi were approximately 100 times higher than the background levels.

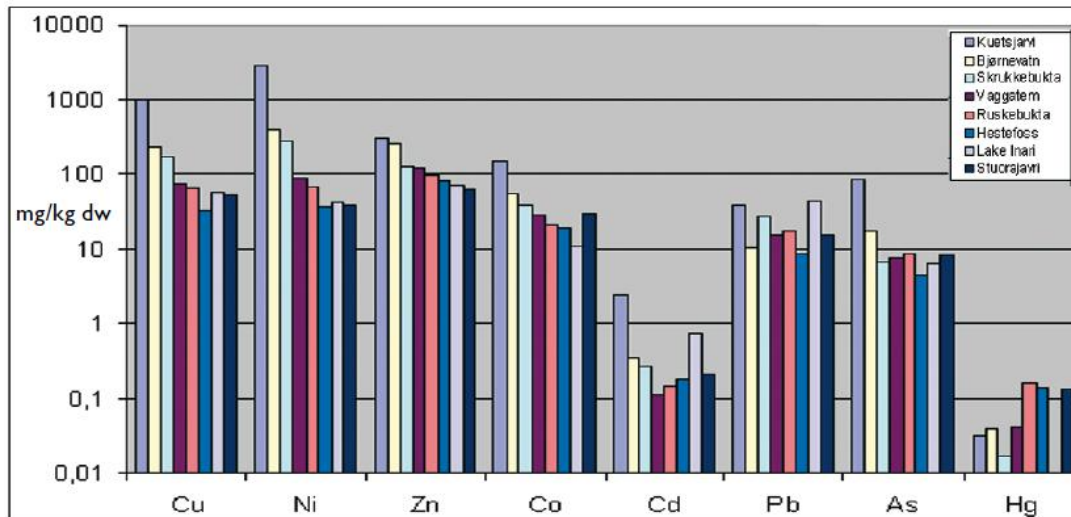


Figure 25. Distribution of element concentrations (mg/kg dw) in the upper layer (0–1 cm) of sediment cores in the Pasvik watercourse. Bjørnevatn and Skrukkebukta are located downstream, while Hestefoss, Ruskebukt and Vaggetem are located upstream from the Pechenganikel industrial complex (From Stabel et al. 2007).

The highest  $\Sigma$ PAH-erylene concentrations (2.1–12.9 mg/kg dry weight) were found in sediment samples collected in Lake Kuetsjarvi (3 stations), in the immediate vicinity of the Nickel smelters. The PAH concentrations were considerably lower both in Bjørnevatn and Skrukkebukta (downstream from the smelters), and also at the stations upstream from the smelters.

The concentrations of  $\Sigma_{64}$ PCB in the Pasvik watercourse varied from 10.5 to 36.4 ng/g dw. The highest PCB concentrations occurred in the bottom sediments from Lake Kuetsjarvi (36.4 ng/g d.w.). There was a decreasing trend also in PCB concentrations with increasing distance from the smelter. The PCB concentrations in the Pasvik watercourse are high compared to those reported for surface sediments in other lakes in Northern Norway.

### 3.3.3 Fish

Fish from the Pasvik watercourse is an important food source for the people in the area. There are more than 15 species of freshwater fishes in the Lake Inari – Pasvik watercourse. The fish community is a mixture of eastern, western and man introduced species. The most important fish species for food consumption are whitefish (*Coregonus lavaretus*), trout (*Salmo trutta*), perch (*Perca fluviatilis*) and pike (*Esox lucius*). The fish resources are utilised commercially, in household and for recreational purposes, but the utilisation varies between the three countries (Aspholm, 2004).

Several studies of effects of acidification and metal emissions on fish and other freshwater biota have been carried out in the border area during the last decade



(e.g. Lukin & Kashulin 1991; Nøst *et al.* 1991; 1997; Amundsen *et al.* 1993; 1997; Kashulin *et al.* 1999; Lukin *et al.* 2003). Also studies of ecology and food web structure in the aquatic communities (e.g. Bøhn and Amundsen 1998, 2001, Amundsen *et al.*, 1999, 2003), fisheries and environmental management and conservation (Mutenia & Salonen 1994, Salonen 1998, Amundsen *et al.*, 1999, Bøhn 2002) have been performed.

Elevated metal levels have been documented in fish from lake localities in the lower part of the Pasvik watercourse (Amundsen *et al.* 1993; 1997; Kashulin *et al.* 1999; Lukin *et al.* 2003). In this area, and particularly in Lake Kuetsjärvi nearby the smelters, a number of pathological modifications have been found in fish organs and tissue (including nephrocalcosis, liver cirrhosis, spleen and gill haemorrhages and skin de-pigmentation) (Lukin & Kashulin 1991; Nøst *et al.* 1991; 1997; Langeland 1993; Kashulin *et al.* 1997; 1999; Lukin *et al.* 2003). The prevalence and severity of these problems increase with decreasing distance to the smelters, and the abnormalities have therefore been related to metal pollution (Lukin & Kashulin 1991; Nøst *et al.* 1991; 1997; Langeland 1993; Kashulin *et al.* 1997; 1999; Lukin *et al.* 2003).

A screening study on PAH and POP concentrations in fish was performed in fish from six lakes located at increasing distance from the smelters: Lake Inari in Finland, Rajakoski and Kuetsjarvi in Russia, and Vaggatem and Skrukkebukta in Norway, as well as a reference lake (Stuorajavri) in the Kautokeino-Alta watercourse, Norway (Christensen *et al.* 2007). The Pechenganikel combine appeared to have a major influence on heavy metal concentrations in freshwater fish in the vicinity of the industrial areas. The highest concentrations of most of the metals, PAHs and POPs occurred in fish from Kuetsjarvi. (Figure 26). The levels of POPs in fish and sediments were higher from lakes downstream the smelters compared to the fish upstream the smelters. This is also confirmed by a new screening study made on perch, whitefish, pike and trout (Christensen 2011). This indicates that emissions and runoff from the industrial activities associated with the Nickel smelters are the main source for these contaminants.

The highest concentrations of most of the metals were measured in internal organs, including liver, kidney and gills, and the lowest concentrations in muscle tissue. Metal concentrations were of a similar magnitude in the individual fish species. However, the Ni and Cd concentrations were generally highest in whitefish, while Hg-concentrations were highest in muscle tissue from perch and pike (Christensen *et al.* 2007). Hg concentrations in muscle of trout, perch and pike were between 0,4 and 0,5 mg/kg wet weight which is very close to the maximum allowed limit of 0,5 mg/kg wet weight for fish (Christensen 2011).

The concentrations of PAHs and POPs in the analysed fish did not exceed the maximum permissible concentration (MPC) for fish (Hygienic norms, 2003).

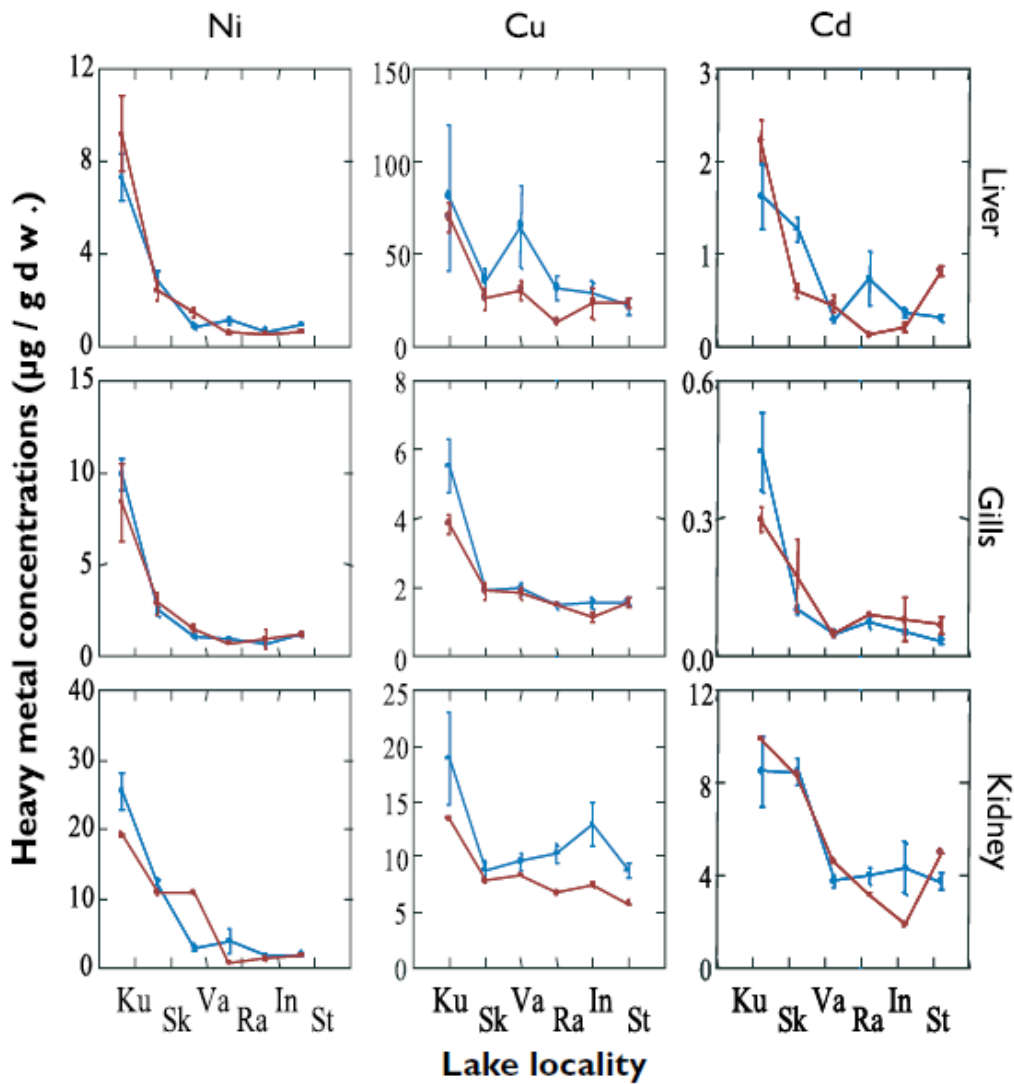


Figure 26. Concentrations of Ni, Cu and Cd in different organs of SR (sparsely raked) and DR (densely raked) whitefish (blue and red lines, respectively) in lakes with increasing distance to the Pechenganickel smelters. Ku = Kuetsjarvi, Sk = Skrukkebukta, Va = Vaggatem, Ra = Rajakoski, In = Lake Inari, and St = Stuorajavri. Vertical bars indicate S.E.

## 4 Marine ecosystems

The marine ecosystem can be affected by pollution from the Russian smelters through the Pasvik watercourse. However, there are many other potential sources for contaminants in the marine ecosystem of the Barents Sea, and it is therefore difficult to assign any contaminants in marine sediment, invertebrates, fish, seabirds or mammals directly to emissions/discharges from the smelters on the Kola Peninsula. The Kola industrial complex is one of many sources for the contaminants measured in the marine ecosystem. In the following sub-chapters an overview of the contaminant status in the marine environment close to the Norwegian- Russian border area is given. Some information about sediment levels is given, but the main focus is on fish and invertebrates that are used for human consumption.

### 4.1 Sediment

The marine environment on the Norwegian side of the border is usually perceived as relatively clean. Generally levels of contaminants are low in open sea areas. However, in harbour areas elevated levels of PAH, PCB, TBT and metals occur. The sources for these contaminants are mainly local harbor activities or runoff from cities. Close to the Russian border it is to our knowledge only harbor sediment from Kirkenes that has been studied. In a study conducted by Norconsult (2008) high levels of Cu, PAH and TBT were measured in the harbor area of Kirkenes. The highest levels were measured close to a local shipyard and Norconsult conclude that the shipyard is the most important source for the measured contaminants. Risk analyses conducted according to the Norwegian Environment Agency's risk assessment tool for contaminated sediment (Bakke *et al.* 2007, TA- 2230/2007) indicate that consumption of seafood caught in the inner harbor area should be avoided. However, no official dietary advices on this has been issued by Norwegian food authorities.

Also the sediment outside the quay of AS Sydvaranger has high levels of PAH, PCB and TBT. Levels of metals were low to moderate in the same area, but relatively high levels of Cd was measured in sediment from one station (Evenset & Birkely 2007). The source for the contaminants in this area is mainly the local industrial activities (AS Sydvaranger).

There are few published studies from the marine environment on the Russian side of the border. However, Savinov *et al.* (2003) analysed sediment from Guba Pechenga for PCB, chlorinated pesticides (DDT, HCB, HCH) and PAH. The study also included stations from Varangerfjord, Guba Malaya Volokovaya and Guba Bol'shaya Volokovaya (south-western Barents Sea). Levels of PCB, DDT and PAH were relatively high in sediment from Guba Pechenga compared to

levels in northern Norwegian fjords or the open Barents Sea (Savinov *et al.* 2003). In the Varangerfjord contaminant levels were generally low. This indicates that the main source for contaminants in Guba Pechenga is local harbour activities rather than transport from the industrial plants on the Kola Peninsula.

#### 4.2 Fish and invertebrates

Fish and blue mussels from one station in the Varangerfjord has been monitored from 1993 until today through the Coordinated Environmental Monitoring Program (CEMP). Samples of blue mussel, plaice and cod have been analysed for a range of persistent organic contaminants and metals. In addition dogwhelk has been analysed for TBT. In general metal levels are low in the samples from Varangerfjorden. For most metals levels are stable or show a decreasing trend from 1993 – 2011 (Green *et al.* 2012).

Only cadmium in plaice liver from Skogerøy in the Varangerfjord shows a significant upward trend and was over acceptable levels. However the cause of the upward trend in plaice from the Varangerfjord is uncertain and could indicate a local impact on plaice (Green *et al.* 2012). Levels of Hg in plaice- and cod-fillet and in blue mussels from Varangerfjorden are low and well below EUs limit for human consumption (0.5 mg/kg ww) (Green *et al.* 2012). Also levels of TBT in blue mussel and dog whelk are low and show a significant downward trend. The same trend is manifested for levels of organic contaminants (PCB, DDT, HCB, HCH) in cod, plaice and blue mussel (Green *et al.* 2012).

The Norwegian National Institute of Nutrition and Seafood Research (NIFES) has monitored the content of pollutants in Northeast Arctic cod from the Barents Sea each year since 2006, and more sporadically back to 1994. The Institute of Marine Research (IMR) has monitored the content of organic pollutants in cod from the Barents Sea since 2000. Liver and fillets from fish caught in different areas of the Barents Sea have been analysed for PCBs, dioxins, PBDEs, PAHs, PFCs, DDT, HCB, HCH, chlordan, toxaphene and metals. The levels reported from these programs are probably representative of levels in the open areas of the Barents Sea, and for the fish that is relevant as food source for the Finnmark population.

The results show that contaminant levels generally are low in cod from the Barents Sea. Levels of Hg (Figure 27) have been low and stable since 1994, and levels of Pb and Cd are low. All metals are present in levels that are below EUs limits for human consumption.

Levels of dioxins and dioxin-like PCBs in cod liver have been relatively stable from 2006 – 2010 (Figure 28). In 2010 levels in 21 of a total of 94 samples of cod liver exceeded EU maximum level for human consumption (25 ng TE / kg wet

weight). But in contrast to the fatrich liver, the lean cod filet has low levels of dioxins and dioxine-like PCBs.

Also concentrations of PCB7 and PBDEs are generally much higher in cod liver than in fillets. There is no set limit for food safety for PCB7 and PBDEs, but the Norwegian Environment Agency has developed a classification system for PCBs. According to their system levels of PCB7 in the fillet have always been well within class I – Insignificant pollution/background. In 2010 also all liver samples corresponded to class I (NIFES 2011).

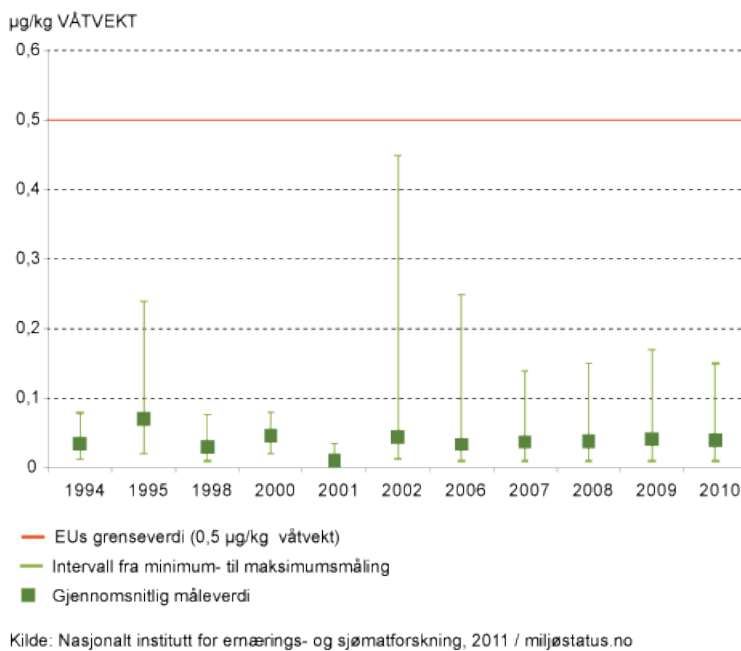


Figure 27. Levels of mercury (Hg, µg/kg wet weight) in cod filet from the Barents Sea in the period 1994 – 2010 (Source: National Institute of Nutrition and Seafood Research, NIFES 2011/miljostatus.no). EU limit for human consumption shown as red line.



Figure 28. Levels of PCDD/F + dioxin like PCBs (µg/kg wet weight) in cod liver from the Barents Sea in the period 1994 – 2010 (Source: National Institute of Nutrition and Seafood Research, NIFES 2011/miljøstatus.no). EU limit for human consumption shown as red line.

The levels of cesium-137 (Cs-137) in cod shows a downward trend (Figure 29), and are far below the EU limit for human consumption (600 Bq/kg wet weight). The Chernobyl accident in 1986 is still the main source of Cs-137 in cod.

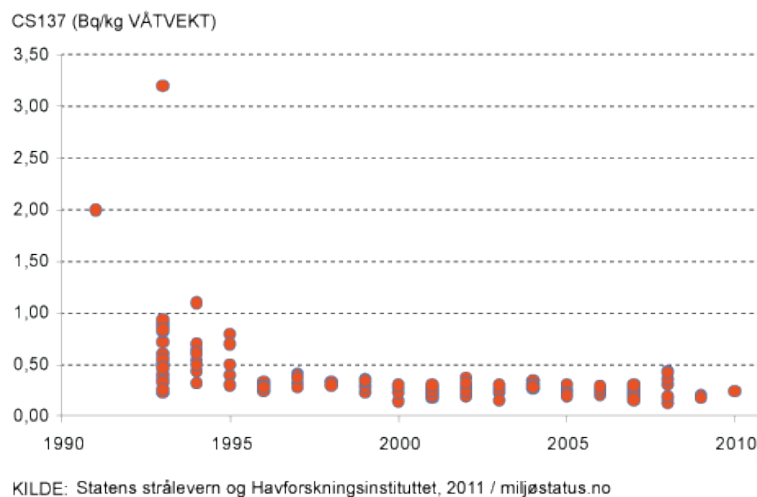


Figure 29. Cs137 (Bq/kg wet weight) in cod from Finnmark (Source: Norwegian Radiation and Protection Authority and Institute of Marine Research 2011).

Most data on contaminant levels in fish are available for cod, since this is the commercially most important species. However, also other species have a commercial interest and some of these may be more vulnerable for contaminants than cod. This is the case for e.g. Greenland halibut. This is a long-lived species that can reach large sizes and have a high lipid content. NIFES has recently collected 1288 samples of Greenland halibut from different Norwegian sea areas (Figure 30). One of the investigated areas was off the coast of eastern Finnmark. The samples were analysed for a range of organic contaminants and metals. The results from the analyses showed that 7.7 % of the samples had Hg-levels that exceeded EUs limit for human consumption (0.5 mg/kg ww). However, none of the halibuts caught in East Finnmark had Hg-levels that exceeded this limit. In 25 % of the samples EUs limit for human consumption was exceeded for dioxins and dioxin-like PCBs<sup>9</sup> (8 TE/kg ww). In general also levels of dioxins and dioxin-like PCBs were low in Greenland halibut from Eastern Finnmark, and the EU-limit was only exceeded in one fish from this area (Nilsen *et al.* 2010). The results from this study indicate that the marine environment in general is little affected by industrial activities in Russia and Norway. However, certain areas close to cities or industrial harbours have significantly higher contaminant levels than the open sea areas.

---

<sup>9</sup> Analytical uncertainty not subtracted. As a general rule the analytical uncertainty must be subtracted from the determined level before dietary advices are issued. When this was done the EU-limit was exceeded for fewer fish samples (Nilsen *et al.* 2010).

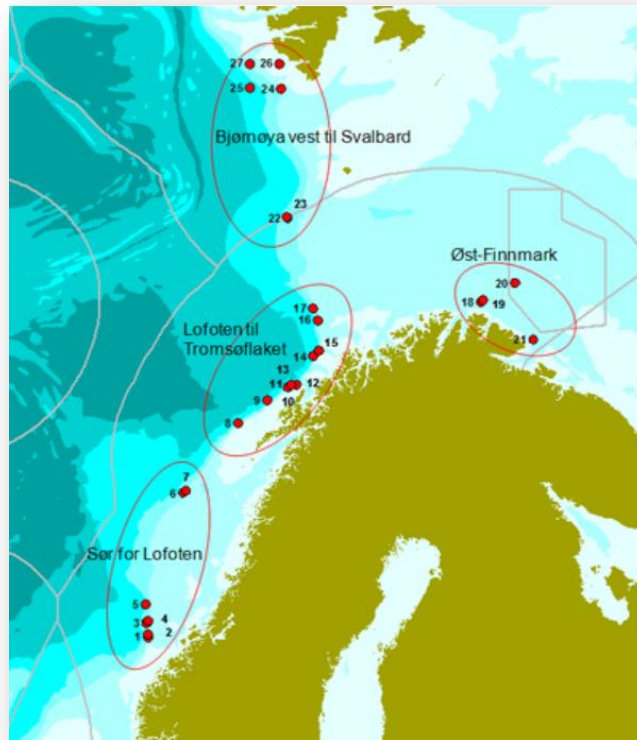


Figure 30. Stations where samples of Greenland halibut (*Reinhardtius hippoglossoides*) were collected for analyses of contaminants (Figure from Nilsen *et al.* 2010).

However, more stationary species living in shallow areas close to the shore may be more exposed to industrial contaminants than more migratory species living in deeper sea areas. One species that has gradually become more and more important as a food source for humans is the king crab. No studies of metals or organic pollutants in this species have to our knowledge been performed. Recent studies along the coast of Nordland show that edible crab/brown crab has levels of Cd that are higher than EUs limit for human consumption (Anon 2012; 2011). The reason for this is currently unknown (Falk *et al.* 2012). Samples of king crab should be analysed in order to investigate if enrichment of Cd and other metals occur in this species.



## 5 The Terrestrial environment

The soil close to the smelters contains extremely high concentrations of a wide range of heavy metals, representing accumulation over the lifetime of the smelters. Elevated heavy metal concentrations extend up to a distance of 30 - 40 km from the smelters (Derome *et al.* 2008). However, there are indications that also areas further away from the Kola Peninsula, such as Bjørnøya, receives input of metals from the smelter industry (Evenset *et al.* 2007). Even though the area close to the smelters receives acid rain (caused by SO<sub>2</sub> emissions from smelter), the soil in the immediate vicinity of the smelters is not suffering from soil acidification. In the border region the bedrock is mostly calcareous and except in small patches the soils are relatively resistant to acidification by depositing pollutants (Derome *et al.* 2008).

### 5.1 Soil

Although a relatively high proportion of the metals that are present in soil are in an immobilized form, the concentrations of bioavailable metals are still high. Accumulation of metals in the litter and organic layer is reflected in heavy metal concentrations in plants, such as grasses and dwarf shrubs, as well as in the needles and leaves of trees. In a study conducted by Lyanguzova (2011) it was shown that seeds from areas close to the smelters had elevated metal concentrations, and that this was limiting seed propagation. Transboundary air pollution from industries in Nikel and Zapolyarnij has caused severe damage to the environment in Southern-Varanger in Norway and in Pechenga municipality in Russia (Tømmervik *et al.* 1998). During the period 1973 - 1999, the effects of air pollution on the terrestrial ecosystems in the border areas was investigated by the use of satellite remote sensing (Tømmervik *et al.* 2003). Satellite data in combination with field work data collected in the period 1970 - 2000, were applied to produce land cover maps for seven different years, with an overall accuracy of 75 – 83 %. The conclusion from the monitoring was that the main effect of air pollution was that the areas of lichen (*Cladina* spp.)-dominated forests and mountain heaths were reduced from 37 % in 1973 to 10 % in 1994, followed by a slight increase to 12 % in 1999 (Tømmervik *et al.* 2003).

## 5.2 Plants

Epiphytic lichens growing on the surface of the tree trunks and branches are sensitive indicators of atmospheric pollution, especially that with sulphur compounds. Close to the industrial works in the heavily contaminated territories epiphytic lichens are absolutely absent. Their amount grows gradually eastwards from the smelters, but in the northern and southern directions epiphytic lichens can only be found at distances of 30 - 50 kilometers away from the industrial facilities.

Today there are signs of a slight recovery in the condition of terrestrial ecosystems in the area around the emission source, e.g. the reappearance of pioneer species of bryophytes and lichens, and the marked recolonization of epiphytic lichens on the least polluted areas to the west of the smelters (Stebel *et al.* 2007). Satellite imagery indicates that there has been an increase in lichen coverage in the area from 1994 to 2004, which is related to the reduction in emissions during the past 10 years. Furthermore, there has been an increase in the vitality of birch and bilberry (measured as photosynthetic efficiency) south of the smelters, as well as a smaller increase towards the north (Symon 2008).

Mosses may be used as bioindicators for metal deposition from the atmosphere to terrestrial systems. The continuing emission of heavy metals is clearly reflected in the metal concentrations in mosses up to a distance of ca. 30 – 50 km from the smelters (Ayras *et al.* 1997). However, elevated levels of Cu and Ni are also found in mosses over a larger area (Figure 31) (Harmens *et al.* 2007). The affected area seems to have decreased from 1990 to 2005. However, this conclusion is the opposite of that drawn by Derome *et al.* (2008), who claims that the accumulation of heavy metals (especially Ni) in mosses has increased during the past 15 years. National surveys of mosses reveal a steady increase of Ni and Cu levels in East Finnmark during the period 1977-2005 and no decrease in levels was observed in data from a survey in 2010 (Steinnes *et al.*, 2011a; Steinnes *et al.* 2011b).

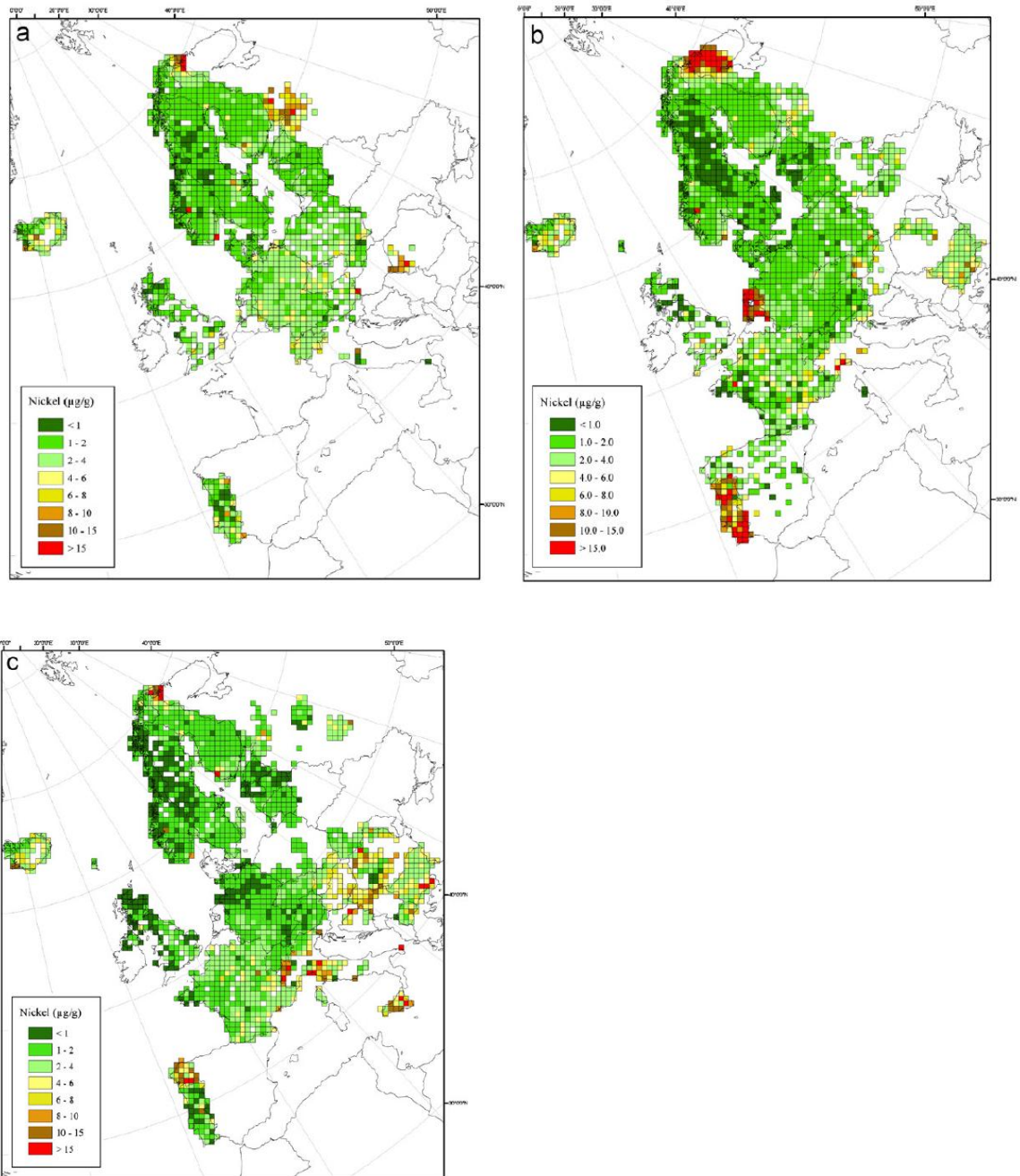


Figure 31. The mean concentration of nickel in moss per EMEP grid square (50km x 50km) for 1990 (a), 1995 (b) and 2000 (c). Source Harmens et al. 2007).

### 5.3 Edible berries

In 1992 the content of heavy metals in cloudberries and bilberries was studied in Sør-Varanger, Norway (Aamlid and Skogheim 1993), and much higher concentrations of Cu, Ni, and partly As, were reported closest to the smelter in Nikel than in reference areas. A more recent project involving Russia, Finland and Norway (Stebel *et al.* 2007) also showed strongly elevated levels of heavy metals in the vegetation in the vicinity of Nikel. The heavy metal concentrations in berries exceeded Russian maximum concentration limits for heavy metals in vegetables. However, the berry samples were not rinsed with water before analyses so it is unclear if the metals are present in the berries or in particulate matter on the surface of the berries (Stebel *et al.* 2007). In a more recent study Myking (2008) analysed samples of cloudberries from Sør-Varanger for metals. Concentrations of Cu, Ni, Cd and particularly manganese (Mn) were notably higher in the areas close to Nikel than more distant areas, showing that the emissions from the smelting industry still were affecting the surroundings. There were small geographic differences in the concentrations of iron (Fe), and the concentrations of As and Co were below the limit of quantification. However, metal levels in cloudberries were significantly lower in 2008 than in 1992.

As part of a KolArctic-funded project (CEEPR -Collaboration Network on EuroArctic Environmental Radiation Protection and Research) mushrooms, berries, soil and vegetation was collected on the Norwegian side in August 2012. These samples are currently being analysed for radionuclides, but as far as we know metal analyses are not included in this project.

### 5.4 Birds and mammals

Several studies around non-ferrous smelters have shown that metal levels are elevated in birds residing close to the smelters (Berglund *et al.* 2011; Eeva *et al.* 2012). This has been shown to have an effect on bird population densities, species diversity and bird biomass (Eeva *et al.* 2012). It has also been shown the energy expenditure for reproduction is higher for passerine birds in areas affected by emissions from smelters than in unaffected areas (Bel'skii & Bezel 2012). Studies from Finland have shown that metal levels in passerine birds decrease relatively rapidly with distance from smelters and as emissions are reduced. Levels of the individual metals decreases relatively rapidly to levels that are below those associated with subclinical effects. However, it is important to be aware of the fact that even though single-element concentrations are below critical levels, the mixture of toxic elements may indirectly affected health and reproduction (Berglund *et al.* 2012).

Passarine birds need extra calcium during their breeding for developing egg shells and proper growth of nestling skeleton. Eeva *et al.* (2010) have shown that

pollution from smelters may affect the diversity, abundance (available shell mass) and individual quality of land snails that is an important calcium source for birds. This effect is posing reproductive problems for birds that rely on snails as calcium sources during breeding. According to Eeva *et al.* (2010) there are probably both direct pollution-related (heavy metal and calcium levels) and indirect (habitat change) effects behind the observed changes in snail populations.

In Pasvik there are ongoing studies that aim at looking at reproductive success in pied flycatchers residing in different distances from the smelters in Nikel (Oddmund Kleven, NINA pers. comm.).

When it comes to mammals, many of the studies performed are relatively old, and changes may have occurred during recent years as emissions has been reduced. Kalas *et al.* (1995) showed that kidney and/or liver samples from capercaillie (*Tetrao urogallus*), willow ptarmigan (*Lagopus lagopus*), hares (*Lepus timidus*), common shrews (*Sorex araneus*) and grey-sided voles (*Clethrionomus rufocanus*) from the Norwegian areas most heavily contaminated by pollutants from the Russian smelters had higher levels of Cu and Ni than samples from a reference area further south in Norway. Also the concentration of Cr was somewhat elevated close to the smelters. Relatively high concentration of Hg and slight increases in Pb was also documented, but regional differences within Sør-Varanger indicated no direct relationship to the Russian smelters. No samples showed concentrations of any metals in excess of the limits where negative effects on animals can be measured (Kalas *et al.* 1995).

The ratio between the species and population sizes of small mammals demonstrate changes in the vicinity of the smelters. The density of populations of the gray-sided vole, the northern red-backed vole, and the common shrew is lower at a distance of 7 km from the smelters than that at a distance of 13 km from the smelters. Besides, gray-sided voles in these areas are five times more numerous than northern red-backed voles. In the background areas, by contrast, northern red-backed voles usually prevail (Symon, 2008).

Contaminants and in particular toxic elements in liver from game such as reindeer and moose have been of special concern due to selective accumulation in the liver. On this basis toxic elements in game have generally been assessed in the liver. At the same time very few people eat the liver from these animals and from a human risk assessment perspective meat values would be more useful. In a recently published PhD thesis (Hassan, 2012), poor correlation was obtained between meat and liver values indicating that liver values are not very useful for assessing human exposure from reindeer and moose. Further assessment in reindeer meat samples showed no increase in concentrations of the elements Cd, Pb, Cu, Ni and V towards the Russian border. Thus the increasing concentrations of toxic elements in air, soil and lichen are not reflected in reindeer meat concentrations. The only exception to this was for As where elevated concentrations were

detected closer to the Russian border (The Svanvik and Jarfjord districts). The reason for this was however concluded to be the composition of soil rather than the emissions from the Russian smelters. There was no information on the concentrations of Hg.

All estimated intake values on the basis of the reported concentrations were however well below provisional tolerable monthly intake (PTMI) and guideline values and thus indicate that reindeer meat is not a significant source of toxic elements for humans in this region either (Hassan, 2012).

Elevated concentrations of dioxins have however previously been reported in reindeer meat from the Svanvik area (Kvalem, 2005), where both dioxins and dioxin-like PCBs were determined. On this basis the Norwegian Food authority issued a dietary advice to reduced intake of reindeer meat. The original link has been removed as the dietary advice is no longer valid. The rationale for posting the advice or removing it is not clear, especially considering that the assessment in meat was for only one meat sample from the Svanvik area in 2003. The sources of these dioxins have originally been indicated to be local mining and metallurgical industry on the Norwegian side of the border.

Thus, there is a clear need to assess dioxins in reindeer meat from the area in a larger number of animals (pooled samples).

## **6 Human health risks and food security**

### **6.1 The Norwegian Russian Health Study 1994-1995**

A large health study was carried out on the Norwegian and the Russian side of the border in 1994-95. Results from the study are presented in one large report, one PhD thesis and a number of scientific papers (Smith-Sivertsen *et al.*, 1997; Smith-Sivertsen, 2000). It was a cross-sectional population based study and the aim was to investigate possible health effects from Ni and SO<sub>2</sub> pollution. 3671 adults between the ages of 18 and 69 years participated. The study was questionnaire-based with additional blood and urine samples collected for exposure measurements. The report from 1997 (Smith-Sivertsen *et al.*, 1997) concluded that no major health effects could be ascribed to Ni and SO<sub>2</sub> pollution on either sides of the border. The PhD-thesis from 2000 (Smith-Sivertsen, 2000) concluded in a similar way that Ni allergy is not associated with Ni exposure from the Russian smelters and that short term increase in SO<sub>2</sub> exposure was not significantly associated with lung function decrements. The reports did however reveal some very interesting findings; i) It was concluded that the Ni exposure as estimated by Ni in urine was high in Russia and low in Norway compared to formerly proposed background values. In both countries the differences between the study and reference populations were small; ii) The vicinity to a Russian Ni refinery did not predict Ni concentrations in urine in either country with the exception of the population of Nikel. Thus they conclude that there is an unidentified non-industrial exposure of importance; iii) persons in all Russian

areas studied had higher urinary Ni concentrations than the Norwegian ones; iv) Ni allergy prevalence was high in Sør Varanger compared to the Nikel/Zapoljarny population; v) the authors also concluded that this prevalence-difference might be partly explained by early ear piercing in the Norwegian population and the slow development of Ni allergy; vi) the low prevalence of Ni allergy among women in Nikel/Zapoljarny, together with the fact that urinary Ni concentrations were not associated with Ni allergy, makes it unlikely that Ni pollution influence Ni allergy and; vii) that there were no clear association between daily changes in SO<sub>2</sub> concentrations and lung function, and lung function was slightly higher than predicted on both sides of the border. No conclusion could be made about the negative effects of long term exposure to SO<sub>2</sub>.

New findings however, does not support all of the abovementioned conclusions. The new findings in relation to exposure to both Ni and SO<sub>2</sub> are described in more detail below in relation to allergy, asthma and cardiovascular disease. Also, the fact that Tromsø was used as a reference group might have interfered with the interpretation of the results in the reports because, Tromsø has a much higher prevalence of Ni allergy than the general population in Norway.

Knowledge gaps in relation to Ni and SO<sub>2</sub> exposure and human health effects are discussed and summarized in the sections below.

## 6.2 Allergic disease and asthma

### *Allergy*

Allergy is linked to exposure to foreign substances (antigens) that cause, in some individuals, an immunoglobulin E-response which in turn manifests itself as allergic symptoms. These symptoms can range from itchy episodes and sneezing to acute anaphylactic shock. The antigens (or allergens) are mostly proteins and glycoproteins that have a molecular weight between 5000 and 100 000 Dalton (Da) and common allergens include pollens, fungal spores, house dust-mites and animal epithelial materials (Shah and Grammer, 2012). Nickel allergy is an allergic response to Ni. The Ni is introduced to the body mainly through skin contact, through the lungs (air pollution) or through the intestines (food). Increased exposure leads to increased incidence and this allergy is more common in women than men because of exposure to jewelry (Tammaro *et al.*, 2011) Allergy is not a uniform term, but allergy in general (or positive test results) is common in Norway with a proportion of positive test results in the Norwegian population between 20 – 40 % (Nystad *et al.*, 1999). The exact status of the difference in prevalence of allergy between Russia and Norway today is not known, but a study from 2001 (Selnes *et al.*, 2001), confirms that the prevalence is higher in Norway. For Ni allergy specifically, the prevalence in Northern Norway (Sør Varanger) was 27.5 % in females and 5.1 % in males (Dotterud and

Smith-Sivertsen, 2007) which is higher than in North West Russia (Smith-Sivertsen *et al.*, 1999). New studies are needed in order to establish the current prevalence of Ni allergy in all age groups and for both genders in Sør Varanger and Murmansk County.

The causative relationship between types of Ni exposure and Ni allergy is not fully understood. Recent studies suggest a considerable contribution from air pollution, especially nickel sulphate, and food (Tammaro *et al.*, 2011) in addition to the well-established association between the allergy and piercings (Smith-Sivertsen *et al.*, 1999). When studying this locally it is important to take into consideration that the Norwegian population in general is more likely to develop allergies than the Russian population. Local differences in concentrations of other contaminants might also play a role. A number of environmental contaminants, have been linked to an immune system response, such as perfluorooctanesulfonate which has been shown to be strongly negatively associated with antibody concentrations in children (Granjean *et al.*, 2012). This might in turn influence the development of allergic disease.

### *Asthma*

Asthma can also be linked to exposure to external factors, not unlike allergy, but has other additional direct and underlying causes. “Asthma is a disorder that causes the airways of the lungs to swell and narrow, leading to wheezing, shortness of breath, chest tightness, and coughing” (Pub Med Health. Asthma, 2013). The asthma symptoms can be triggered by many of the abovementioned allergy-causing substances. Specifically; animals, dust, mold and pollen, but also by changes in weather and chemicals in the air or in the food can induce allergy and asthma (Pub Med Health. Asthma, 2013).

The underlying causes leading to asthma development in individuals will not be discussed in detail, but in general, frequency of children with asthma symptoms is higher in wealthy countries than in less affluent countries (Hedlin *et al.*, 2012). For pregnant women in particular, the difference in reported prevalence of asthma between Norway and Russia is staggering. 6 % of pregnant women in Finnmark were diagnosed with asthma in 2011 (Folkehelseinstituttet, 2013a), while in Murmansk County the proportion was 0.6 % in 2006 (Anda, 2013). Asthma is more common among women than men, but among children, boys are more likely to have asthma than girls (Sterling, 2012). Numbers from the Norwegian Institute of Public Health indicate that the prevalence of asthma (just like for allergies) is higher in Northern Norway and Finnmark than the national average. These numbers, however, are somewhat outdated (Folkehelseinstituttet, 2013b).

Individuals with asthma are often more sensitive to certain air pollutants, such as dust, molds, chemicals and pollen, than non-asthmatics. For example particulate matter (PM) is shown to have some negative effects in asthmatics, although this



relationship is usually not an independent one; it is linked to amongst other exposure to NO<sub>2</sub>, SO<sub>2</sub> and ozone (O<sub>3</sub>) (Lin et al, 2002). Five to ten percent of patients diagnosed with asthma are allergic to sulfites, including SO<sub>2</sub> (technically a bisulfite) (Grayson and Holtzman, 2005). These individuals can experience asthma symptoms at concentrations of SO<sub>2</sub> as low as 99 µg/m<sup>3</sup> (Vancouver Island Health Authority, 2013) (one hour daily average concentrations) and as low as 20 µg/m<sup>3</sup> if the exposure persists for 24 hours (WHO, 2006). From a report for the former Norwegian Climate and Pollution Agency, report number TA-2951/2012, (Berglen *et al*, 2012) it is evident that these levels of concern are exceeded numerous times a year in the area.

The effect of air pollution could be more substantial in the Norwegian than the Russian population simply because there is a much higher prevalence of asthma in Norway. This difference in prevalence might be caused by differences in susceptibility. In either case it is a concern, especially related to the most vulnerable groups: pregnant women, children and the elderly. However the actual population at risk is not known.

#### ***Knowledge gaps in relation to allergy and asthma***

To be able to evaluate the risk to the population in Sør Varanger it is paramount that the actual risk-groups are identified and that the information is up to date. This includes in particular; i) the prevalence of nickel allergy in adults and children, ii) the status of the immune system in children, iii) prevalence of asthma in children and adults and iv) the prevalence of asthmatics with sulfite sensitivity. In order to link these outcomes to specific exposures, several risk factors needs to accurately estimated, such as; i) nickel sulfate exposure, ii) ) blood levels of relevant contaminants iii) more measurements of SO<sub>2</sub> in air (geographically). For the purpose of establishing possible causation similar information must be obtained from a control group in Norway and possibly in Russia as well. The authors recommend in particular, that a study similar to the Norwegian-Russian Health study (Section 6.1) is initiated.

### **6.3 Cardiovascular disease**

Cardiovascular disease (CVD) is any disease that involves the heart or the blood vessels. CVD is for the first time in history the leading cause of death in the world (WHO, 2011). New investigations show that air pollution in the form of PM (with or without the presence of ozone) negatively affects the blood pressure in healthy individuals in concentrations as low as 150 µg/m<sup>3</sup> (2 hour average) (Brook *et al*. 2009), and lower for people over the age of 65 especially with systemic inflammation and overweight (Huang *et al*. 2012). The Norwegian guidelines for levels of concern of PM have, according to the Norwegian Public Health Institute (FHI), not been revised since 1998 (Folkehelseinstituttet, 2013c). A new report is pending (Pers. Comm. Marit Låg FHI).

Indications also exist that there might be a relationship between toxic metals (nickel) deposited and increased circulatory-disease-mortality (Pasanen K. et al, 2012).

As described above, the actual population at risk is not known, but with the new PM level guidelines pending it would be of utmost importance to establish the actual population exposure to PM in Sør Varanger.

#### **6.4 Cancer**

Cancer in itself is not a rare disease, but cancer attributable to environmental contaminants is seldom. For this reason, it is not feasible to study the cause and effect relationship between the contaminants mentioned in this report and cancer in a population as small as the one in Sør-Varanger. The only sensible cause of action in relation to cancer is to actually establish current contaminant measurements in the environment and in foods and then estimate the attributable risk for the population based on age, gender, lifestyle and diet.

#### **6.5 Food security**

It is a well-known fact that many contaminants enter into and accumulate in the food chain. This has been a special concern in the Arctic where long-range-transported-contaminants accumulate, particularly in the lipid rich marine food chain (AMAP, 2009). This situation has led to what is known as “the Arctic dilemma”; easily available and nutrient-rich local food (in some communities the only source of energy) is suddenly transformed into a potential health-damaging source of pollutants. How do you communicate this to the people?

To ensure people that locally produced and locally harvested food is safe for consumption, is important for a variety of reasons: i) The ability to harvest from nature is important for the quality of life and wellbeing; ii) local food may be nutritionally important; iii) harvesting local food often involves physical activity, another prerequisite for good health that should be encouraged and iv) fear of contaminants in local food might have socioeconomic consequences, for example previously reported sporadically elevated levels of dioxins in reindeer meat, and halibut (Kvalem, 2005) and constant elevated levels in seagull eggs (Fylkesmannen i Finnmark, 2011).

On the other hand it is important to be aware that the population is not homogenous and that dietary advice may be segregated. It would, for example, be prudent to advise a pregnant woman against eating seagull eggs or an old inland trout, but it has little value to advise a 70 year old man to consider the same precautions.

Elevated dioxin concentrations have been reported in freshwater fish from lakes close to Kirkenes and the source of exposure has been attributed to the local

mining industry. The concentrations have declined since 1998 and the levels in 2010 were below the maximum level of dioxins in fish; however it was still kept food advisories for freshwater fish from these lakes near Kirkenes<sup>10</sup>. Elevated concentrations of dioxins have also been reported in reindeer meat samples and dietary advice was issued by the Norwegian food authority for reindeer meat from the area. The dietary advice was later removed for no known reason without addition of new data. There is a clear need of updated data on dioxins in reindeer, source of exposure elucidation and also assessment of human samples to clarify if the local population has been exposed to elevated concentrations of dioxins over time. The use of previously collected samples as well collecting new samples would be highly rewarding in order to clarify previous and current exposure.

As previously indicated in this report the increasing concentrations of a number of toxic elements in soils and air have not resulted in increasing concentrations of the same elements in reindeer meat. Reindeer meat is considered healthy and has high nutritional value, low fat content and favorable fatty acid profile. The authors of this report find it surprising that there should be levels of concern of dioxins in reindeer, and clearly more substantiated data is needed to conclude.

All in all, the probability that local food is contaminated to a level of serious concern is low and people most likely stand more to lose by staying away from these foods than to include them in their diet. The challenge is how to convey this in a credible manner to the local population. The newly initiated Kolarctic project (Project no. KO467) aims to deal with this challenge in a productive and balanced manner during the next two years. However, additional funding is needed in the Kolarctic project if actual current dioxin levels in reindeer, fish and humans are to be assessed.

## **7 Conclusions/knowledge gaps**

The industrial facilities at Zapolyarny and Nickel in Russia are approximately 30 km apart and approximately 15 and 5 km from the Norwegian border, respectively. The main pollutants emitted into air are sulphur dioxide (SO<sub>2</sub>) and toxic elements, such as nickel (Ni) and copper (Cu), often attached to dust particles. Additionally, large quantities of metals are discharged into local water bodies through wastewater. The Norwegian-Russian border area has received considerable attention during the last decades because of local industrial pollution, and in this report impacts from local industrial pollution on ecosystem and human health in the Norwegian border region to Russia are presented.

---

<sup>10</sup> <http://www.finnmarken.no/nyheter/article5407527.ece> [ACCESSED 31-10-2013]

**Air:** Although annual industrial emissions of SO<sub>2</sub> from the Russian smelters near the Norwegian border have declined over the past 30 years, there are still episodes where air concentrations exceed Norwegian threshold values at Svanvik and in Karpdalen. Air concentrations of toxic elements such as Ni and Cu do not exceed European and Norwegian target values. However, it is worth noting that concentrations of Ni, Cu and Co (cobalt) in precipitation have increased considerably after year 2004. This increase is also observed in freshwater systems in the area. The trends in concentrations of toxic elements do not correspond with emission estimates provided by Kola Mining and Metallurgical Company (Kola MMC).

**Lakes and rivers:** Acidification of smaller and larger lakes, resulting in serious effects on fish populations, was reported in studies from the mid 1980-ties. But since 1987 all the Norwegian lakes have shown significant decreasing trends in sulphate and hence an improvement in pH-status.

In three Norwegian lakes (Bårsajarvi, St. Valvatnet and Langvatnet) in the border region, water concentrations of Ni have increased from 2005 and until today. Average concentrations of Ni and Cu in water from lakes on Jarfjord Mountain are currently (2010-2012) the highest ever measured. A study from 2010 showed that the concentrations of Cu and Ni in lake sediments were high to extremely high in Norwegian lakes up to 20 km from the Russian smelters. Elevated concentrations were also found for lead (Pb), Co, mercury (Hg), arsenic (As) and cadmium (Cd). Increasing Ni, Cu, As and Hg concentrations from sub-surface to surface sediments were found for lakes at intermediate distances (20-60 km). This may reflect recent changes in atmospheric depositions, as shown in nearby Norwegian areas. The regional lake surveys from 2004 - 2006 also showed a sharp increase of Ni and Cu in the upper part of the sediment profile. New studies (Rognerud *et al* 2013) indicate an escalation in Hg emission from the smelters. No measurements of contaminants have been carried out in fish from lakes, except from the Pasvik watercourse.

Even though Kola MMC report annual reductions in surface water discharge, no effect of this reduction in Ni and Cu concentrations has been observed in the Pasvik watercourse over the past 9 years. Elevated Ni- and Cu-levels have been documented in fish from lakes in the lower part of the Pasvik watercourse, in Lake Vaggatem and Lake Skrukkebukta. Analyses of sediments and fish from the Pasvik watercourse for polyaromatic hydrocarbons (PAHs) and persistent organic pollutants (POPs) have shown elevated levels downstream the smelters compared to upstream. This indicates that emissions and runoff from the industrial activities associated with the Nickel smelters are the main source for these contaminants.

**Terrestrial environment:** In soil samples elevated heavy metal concentrations extend up to a distance of 30 - 40 km from the smelters. Accumulation of metals

in the litter and organic layer is reflected in heavy metal concentrations in plants, such as grasses and dwarf shrubs, as well as in the needles and leaves of trees. National surveys of mosses reveal a steady increase from year 1997 to 2010 of Ni and Cu levels in the Norwegian part of the border area. Even though the area close to the smelters receives acidic precipitation and deposition, the soil in the immediate vicinity of the smelters is not suffering from acidification, due to calcareous bedrock.

Samples of edible berries on the Finnish, Russian and Norwegian side of the border show elevated Ni and Cu concentrations and highest levels near the smelters. A study from 2008 analysed samples of cloudberries from Sør-Varanger for metals. Concentrations of Cu, Ni, Cd and particularly manganese (Mn) were notably higher in the areas close to Nikel than more distant areas, showing that the emissions from the smelting industry still were affecting the surroundings. Metal levels in cloudberries were lower in 2008 than in 1992. However, new analysis are recommended to check the present status and if there is year to year variations.

Studies from Finland and Russia have shown that there are high metal levels in birds residing close to non-ferrous smelters. This may in turn affect bird population densities; however, data on bird densities from the Norwegian border to Russia area is not available.

The high levels of metals in the terrestrial environment have so far not been reflected in reindeer meat. Elevated dioxin levels have been reported in one sample of reindeer meat from the Svanvik area and new dioxin analyses of a representative amount of samples are recommended in order to conclude.

**Human health:** A large health study carried out on the Norwegian and the Russian side of the border in 1994-95 concluded that no major health effects could be ascribed to Ni and SO<sub>2</sub> pollution on either sides of the border. It was also concluded in a similar way that Ni allergy is not associated with Ni exposure from the Russian smelters and that short term increase in SO<sub>2</sub> exposure was not significantly associated with lung function decrements. However, in light of recent studies, new available information on causative relationships and modern scientific methods, it is clear that episodes of SO<sub>2</sub> (and particulate matter) on the Norwegian side of the border have the potential to affect both the incidence and the severity of existing respiratory diseases, especially in particularly vulnerable groups, such as the elderly and children. There is, however, little information about the proportion of the local population that is affected by these SO<sub>2</sub> episodes, both in terms of actual exposure and the number of persons that are particularly vulnerable (the true prevalence of asthma/allergy/other lung disease and cardiovascular disease).

It seems evident that concentrations in the Norwegian environment of certain toxic elements have been increasing lately, but at the same time local foods like reindeer meat has not shown the same increase.

**Marin environment:** The marine ecosystem can be affected by pollution from the Russian smelters through the Pasvik watercourse. However, there are many other potential sources for contaminants in the marine ecosystem of the Barents Sea, and it is therefore difficult to assign any contaminants in marine sediment, invertebrates, fish, seabirds or mammals directly to emissions/discharges from the smelters on the Kola Peninsula. Generally, contaminant levels are low in sediment, invertebrates and fish from the marine sector of the border area. However, elevated levels of metals and organic contaminants are found in harbour areas and close to major settlements.

### **Gaps of knowledge:**

#### *Air measurements*

- Particulate matter (PM 2.5 and 10) measurements should be conducted in Kirkenes and Svanvik/Karpdalen
- Measurements of SO<sub>2</sub>, using passive samplers, should be performed in Kirkenes/Hesseng.

#### *Freshwater environment*

- Lake sediment cores should be dated and analysed for metals and POPs to reveal historical trends. This is the best method for demonstrating time trends.
- Freshwater fish from the Pasvik watercourse should be analysed for organic contaminants.
- Fish from lakes outside the Pasvik watercourse (Jarfjord area) should be analysed for toxic elements.
- A monitoring program for Hg in lake sediment and fish (perch) should be established.

#### *Terrestrial environment*

- The risk related to intake of edible berries and mushrooms collected in the border area should be estimated.
- A representative number of reindeer meat samples should be analysed for dioxins.

#### *Human health and food security*

- Updated information on what local food is used and to what extent should be acquired through questionnaire based studies.
- Dioxin concentrations in humans should be determined over time

- Human health risk related to local SO<sub>2</sub>, PM and nickel sulphate exposure should be assessed:
  - Identify and quantify population exposed
  - Identify and quantify population at risk
- There is a clear need to repeat the Norwegian Russian Health study from 1994-95.

Independent Norwegian monitoring programs on air/precipitation (Berglen *et al.*, 2011), freshwater lakes (Schartau *et al.*, 2011) and mosses (Steinnes *et al.*, 2011a, 2011b) reveal all an increased deposition of metals to the Norwegian border area. We therefore recommend that this knowledge is reflected in a near future study with a broad investigation of metals and other pollutants in local food items such as freshwater fish, birds, reindeer, edible berries and mushrooms.

It is recommended that an interactive web based tool/map is developed, where all the information from the different studies in the border region can be gathered and presented. This will be a valuable tool when risk assessments are to be performed, and can be an asset both for policy makers, the local population and the research community.

## 8 References

- Alm, G., Tröjbom, M., Borg, H., Göthberg, A., Johansson, K., Linderström, L., Lithner, G. (1999) Metaller. In: *Bedömningsgrunder för miljö kvalitet. Sjöar och vattendrag*. Wiederholm, T. (ed.). Stockholm, Naturvårdsverket. (Rapport 4920). pp. 109-172.
- AMAP (2011) Arctic Pollution 2011. Oslo, Arctic Monitoring and Assessment Program (AMAP).
- AMAP (2002) Arctic pollution 2002. Heavy metals in the Arctic. Oslo, Arctic Monitoring and Assessment Program (AMAP).
- AMAP (2009) AMAP Assessment 2009: Human health in the Arctic. Oslo, Arctic Monitoring and Assessment Programme (AMAP).
- AMAP (2000) PCB in the Russian Federation: Inventory and proposals for priority remedial actions. Executive summary of the report of Phase 1: Evaluation of the current status of the problem with respect to environmental impact and development of proposals for priority remedial actions of the multilateral cooperative project on phase-out of PCB use, and management of PCB-contaminated wastes in the Russian Federation. Oslo, Arctic Monitoring and Assessment Programme (AMAP) (AMAP Report, 2000:3).
- AMAP (2004) AMAP Assessment 2004: Persistent Organic Pollutants in the Arctic. Oslo, Arctic Monitoring and Assessment Programme (AMAP).
- AMAP (2002) Report on the Experts Meeting on Sampling and Analysis of Persistent Toxic Substances (PTS), St. Petersburg, Russia, 28 May - 1 June, 2000 (AMAP Report, 6).
- Hassan, A.A., Brustad, M., Sandanger, T.M. (2012) Concentrations and geographical variations of selected toxic elements in meat from semi-domesticated reindeer (*Rangifer tarandus tarandus* L.) in mid- and northern Norway: Evaluation of risk assessment. *Int. J. Environ. Res. Public Health*, 9, 1699-1714. doi:10.3390/ijerph9051699.
- Amundsen, P.-A. (1988) Habitat and food segregation of two sympatric populations of whitefish (*Coregonus lavaretus* L. s.l.) in Stuorajavri, northern Norway. *Nordic J. Freshw. Res.*, 64, 67-73.
- Amundsen, P.-A., Bøhn, T., Våga, G.H. (2004) Gill raker morphology and feeding ecology of two sympatric whitefish (*Coregonus lavaretus*) morphs. *Ann. Zool. Fennici*, 41, 291-300.
- Amundsen, P.-A., Staldvik, F., Lukin, A., Kashulin, N., Reshetnikov, Y.S., Popova, O. (1993) Ecology and heavy metal contamination in the fish communities of the Pasvik River system. Tromsø, Norwegian College of Fishery Science, University of Tromsø.
- Amundsen, P.-A., Staldvik, F.J., Lukin, A., Kashulin, N., Popova, O., Reshetnikov, Yu. (1997) Heavy metal contamination in freshwater fish from the border region between Norway and Russia. *Sci. Tot. Environ.*, 201, 211-224.
- Anda, E.E. (2009) The Murmansk County Birth Registry (MCBR). The implementation and applicability of a population-based medical birth registry in the Russian Arctic. Tromsø, University of Tromsø (ISM skriftserie, 104).
- Andersen, J.R., Bratli, J.L., Fjeld, E., Faafeng, B., Grande, M., Hem, L., Holtan, H., Krogh, T., Lund, V., Rosland, D., Rosseland, B.O., Aanes, K.J. (1997) Classification of environmental quality in freshwater. Oslo, Norwegian Pollution Control Authority (SFT veiledning, 97:04) (In Norwegian).



- Arnesen, R., Traaen, T., Moiseenko, T., Kudravtseva, L., Mokrotovarova, O. (1996) Heavy metals from Nikel area. investigation in Kolosjki river 1995, Kola peninsula, Russia. Oslo, NIVA (NIVA-Report, 3543-96).
- Aspholm, P.E. (2004) Fish and fishery resources in the Inari-Pasvik water system. Proceedings from the Conference on Integrated Water Management of Transboundary Catchments: a contribution from TRANSCAT, Venice, Italy, 24-26 March 2004. URL: [http://www.feem-web.it/transcat\\_conf/conf\\_papers/Aspholm.pdf](http://www.feem-web.it/transcat_conf/conf_papers/Aspholm.pdf) [Accessed 23 October 2013].
- Aspholm, P.E. (1996) The Pasvik River - Norway's most extensively developed watercourse. *Barentswatch*, 12-17.
- Ayras, M., Pavlov, V., Reimann, C. (1997) Comparison of sulphur and heavy metal contents and their regional distribution in humus and moss samples from the vicinity of Nikel and Zapoljarnij, Kola Peninsula, Russia. *Water Air Soil Pollut.*, 98, 361-380.
- Bakke, T., Breedveld, G., Kjällqvist, T., Oen, A., Ek, E., Ruus, A., Kibsgaard, A., Helland, A., Hylland, K. (2007) Guidelines for risk assessment of contaminated sediments. Oslo, Norwegian Pollution Control Authority (TA-2230/2007) (In Norwegian).
- Belskii, E.A., Bezel, V.S. (2012) Estimates of energy expenditures for reproduction in the pied flycatcher *Ficedula hypoleuca* Pall. in an industrially polluted environment. *Russ. J. Ecol.*, 43, 218-224.
- Berglen, T.F., Arnesen, K., Rode, A., Tønnesen, D. (2011) Air quality monitoring in the border areas of Norway and Russia – progress report April 2010 - March 2011. Kjeller, NILU (Statlig program for forurensningsovervåking. Rapport 1106/2011. TA 2838/2011) (NILU OR, 31/2011) (In Norwegian).
- Berglen, T.F., Andresen, E., Arnesen, K., Nilsson, L.O., Ofstad, T., Rode, A., Tønnesen, D., Vadset, M. (2012) Air quality monitoring in the border areas of Norway and Russia – progress report April 2010-March 2011. Kjeller, NILU (Statlig program for forurensningsovervåking. Rapport 1128/2012. TA 2951/2012) (NILU OR 25/2012) (In Norwegian).
- Berglund, A.M.M., Koivula, M.J., Eeva, T. (2011) Species- and age-related variation in metal exposure and accumulation of two passerine bird species. *Environ. Pollut.*, 159, 2368-2374.
- Berglund, A.M.M., Rainio, M.J., Eeva, T. (2012) Decreased metal accumulation in passerines as a result of reduced emissions. *Environ. Toxicol. Chem.*, 6, 1317-1323.
- Blais, J.M., Duff, K.E., Laing, T.E., Smol, J.P. (1999) Regional contamination in lakes from the Norilsk region in Siberia, Russia. *Water Air Soil Pollut.*, 110, 389-404.
- Brook, R.D., Urch, B., Dvonch, T., Bard, R.L., Speck, M., Keeler, G., Morishita, M., Marsik, F.J., Kamal, A.S., Kaciroti, N., Harkema, J., Corey, P., Silverman, F., Gold, D.R., Wellenius, G., Mittleman, M.A., Rajagopalan, S., Brook, J.R. (2009) Insights into the mechanisms and mediators of the effects of air pollution exposure on blood pressure and vascular function in healthy humans. *Hypertension*, 54, 659-67.
- Christensen, G.N., Evenset, A., Rognerud, S., Skjelkvåle, B.L., Palerud, R., Fjeld, E., Røyset, O. (2008) National lake survey 2004-2006, PART III: AMAP. Status of metals and environmental pollutants in lakes and fish from the Norwegian part of the AMAP region. Oslo, NIVA (Statlig program for forurensningsovervåking. Rapport 1013/08. TA-2363-2008).

- Christensen, G.N., Savinov, V., Savinova, T. Alexeeva, L., Kochetkov, A., Konoplev, A., Pasyukova, A., Samsonov, D., Dauvalter, V., Kashulin N., Sandimirov, S. (2007) Screening studies of POP levels in bottom sediments from selected lakes in the Paz watercourse. Tromsø, Akvaplan-niva (Akvaplan-niva report 3665.01).
- Christensen, G.N., Savinov, V., Savinova, T. Alexeeva, L., Kochetkov, A., Konoplev, A., Pasyukova, A., Samsonov, D., Dauvalter, V., Kashulin N., Koroleva, I., Sandimirov, S., Morozov, D. (2007b) Screening studies of POP levels in fish from the selected lakes in Paz watercourse. Tromsø, Akvaplan-niva (Akvaplan-niva report 3665.02).
- Christensen, G.N., Dahl-Hansen, G.P., Enge, E.K. (2011) Undersøkelse av dioksiner (PCDD/PCDF) i ferskvannsfisk i Sør-Varanger. Oppfølgingsundersøkelser 2009. Tromsø, Akvaplan-niva (Akvaplan-niva rapport 4733).
- Christensen, G.N. (2011) Miljøgifter i fisk fra Pasvikvassdraget – nye undersøkelser fra 2008. Tromsø, Akvaplan-niva (Akvaplan-niva rapport, 4732).
- Dauvalter, V.A. (1994) Heavy metals in lake sediments of the Kola Peninsula. *Sci. Tot. Environ.*, 158, 51-61.
- Dauvalter, V.A. (2003) Impact of mining and refining on the distribution and accumulation of nickel and other heavy metals in sediments of subarctic Lake Kuetsjarvi, Murmansk Region, Russia. *J. Environ. Monit.*, 5, 210-215.
- Dauvalter, V.A. (2006) Chalcophile elements (Hg, Cd, Pb, and 356 As) in bottom sediments of water bodies of the White Sea catchment area on the Kola Peninsula. *Geochem. Internat.*, 44, 205-208.
- Dauvalter, V.A. (2011) Chemical composition of lake sediments along a pollution gradient in a subarctic watercourse. *J. Environ. Sci. Health*, 46, 1020-1033.
- Dauvalter, V.A., Rognerud, S. (2001) Heavy metal pollution in sediments of the Pasvik River drainage. *Chemosphere*, 42, 9-18.
- de March, B.G.E, de Wit, C.A., Muir, D.C.G. (1998) Persistent organic pollutants. In: *AMAP Assessment Report: Arctic Pollution Issues*. Oslo, Arctic Monitoring and Assessment Programme (AMAP). pp. 183-372.
- de Wit C.A., Muir, D.C.G. (2004) Levels and trends of brominated flame retardants in the Arctic. In: *The third International Workshop on Brominated Flame Retardants, BFR 2004. Toronto, Ontario, Canada, June 6-9, 2004. Book of abstracts*. pp. 109-113.
- Derome, J., Myking, T., Aarrestad, P.A. (eds.) (2008) Current state of terrestrial ecosystems in the joint Norwegian, Russian and Finnish border area in Northern Fennoscandia. Helsinki, Finnish Forest Research Institute (Working Papers of the Finnish Forest Research Institute, 85).
- Dotterud, L.K., Smith-Sivertsen, T. (2007) Allergic contact sensitization in the general adult population: a population-based study from Northern Norway. *Contact Dermatitis*, 56, 10-15.
- Eeva, T., Belskii, E., Gilyazov, A.S., Kozlov, M.V. (2012) Pollution impact on bird population density and species diversity at four non-ferrous smelter sites. *Biol. Conservat.*, 150, 33-41.
- Eeva, T., Rainio, K., Suominen, O. (2010) Effects of pollution on land snail abundance, size and diversity as resources for pied flycatcher, *Ficedula hypoleuca*. *Sci. Total Environ.*, 408, 4165-4169.

- Evenset, A., Christensen, G.N., Carroll, J., Zaborska, A., Berger, U., Herzke, D., Gregor, D. (2007) Historical trends in persistent organic pollutants and metals recorded in sediment from Lake Ellasjøen, Bjørnøya, Norwegian Arctic. *Environ. Pollut.*, 146, 196-205.
- Evenset, A., Birkely, S.R. (2007) Miljøgifter i marint sediment, Kirkenes 2007. Tromsø, Akvaplan-niva (Akvaplan-niva report 3340-1).
- Fjeld, E., Rognerud, S., Steinnes, E. (1994) Influence of environmental factors on heavy metal concentration in lake sediments in southern Norway indicated by path analysis. *Can. J. Fish. Aquat. Sci.*, 52, 1708-1720.
- Folkehelseinstituttet (2013a) Medisinsk Fødselsregister. Sykdom hos mor før svangerskapet. URL: <http://mfr-nesstar.uib.no/mfr/> [Accessed 25 January 2013].
- Folkehelseinstituttet (2013b) Astma - faktaark. URL: <http://www.fhi.no/artikler/?id=58515> [Accessed 30 October 2013].
- Folkehelseinstituttet (2013c) Luftkvalitetskriterier. URL: <http://www.fhi.no/tema/luftforurensning/luftkvalitetskriterier> [Accessed 30 October 2013].
- Fylkesmannen i Finnmark (2011) Miljøgifter i fugl. URL: <http://fylker.miljostatus.no/Finnmark/Tema-A-A/Kjemikalier/Miljogifter/Miljogifter-i-fugl/> [Accessed 30 October 2013].
- Gregurek, D., Melcher, F., Pavlov, V.A., Reimann, C., Stumpf, E.F. (1999) Mineralogy and mineral chemistry of snow filter residues in the vicinity of the nickel-copper processing industry, Kola Peninsula, NW Russia. *Mineral. Petrol.*, 65, 87-111.
- Gregurek, D., Reiman, C., Stumpf, M.E. (1998) Trace elements and precious metals in snow samples from the immediate vicinity of nickel processing plant, Kola Peninsula, North West Russia. *Environ. Pollut.*, 102, 221-232.
- Granjean, P., Andersen, E.W., Budtz-Jørgensen, E., Nielsen, F., Mølbak, K., Weihe, P., Heilmann, C. (2012) Serum vaccine antibody concentrations in children exposed to perfluorinated compounds. *J. Am. Med. Assoc.*, 307, 391-397.
- Grayson, M.H., Holtzman, M.J. (2005) Asthma. *ACP Medicine Online*, July 2005.
- Green, N., Schøyen, M., Øxnevad, S., Ruus, A. (2012) Hazardous substances in fjords and coastal waters – 2011. Levels, trends and effects. Long-term monitoring of environmental quality in Norwegian coastal waters. Oslo, NIVA (Statlig Program for Forurensningsovervåking. Rapport 1132/2012. TA-2974/2012) (NIVA report, 6432-2012).
- Harmens, H., Norris, D.A., Koerber, G.R., Buse, A., Steinnes, E., Rühling, Å. (1997) Temporal trends in the concentration of arsenic, chromium, copper, iron, nickel, vanadium and zinc in mosses across Europe between 1990 and 2000. *Atmos. Environ.*, 41, 6673-6687.
- Hassan, A.E.A. (2012) Nutrients and toxic elements in semi-domesticated reindeer in Norway: Nutritional and food safety aspects. PhD Thesis. Tromsø, University of Tromsø, Faculty of Health Sciences.
- Hedlin, G., Konradsen, J., Bush, A. (2012) An update on paediatric asthma. *Eur. Respir. Rev.*, 21, 175-185.
- Huang, W., Zhu, T., Pan, X., Hu, M., Lu, S.-E., Lin, Y., Wang, T., Zhang, Y., Tang, X. (2012) Air pollution and autonomic and vascular dysfunction in patients with

cardiovascular disease: Interactions of systemic inflammation, overweight, and gender. *Am. J. Epidemiol.*, 176, 117-126.

- Kalas, J.A., Ringsby, T.H., Lierhagen, S. (1995) Metals and selenium in wild animals from Norwegian areas close to Russian nickel smelters. *Environ. Monit. Assess.*, 36, 251-270.
- Kashulin, N.A., Sandimirov, S.S., Dauvalter, V.A., Kudryavtzeva, L.P., Terentjev, P.M., Denisov, D.B., Vandysh, O.I., Valkova, S.A. (2012) Annotated ecological catalogue of lakes of central part of the Murmansk region. Kola Science Centre RAS, Apatiti, Russia. (In Russian).
- Kashulina, G., Reimann, C., Banks, D. (2003) Sulphur in the Arctic environment (3): environment impact. *Environ. Pollut.*, 124, 151-171.
- Kashulina, T.G., Kashulin, N.A. (1997) Accumulation and distribution of Ni, Cu, and Zn in the organs and tissues of fishes in subarctic waters. In: *The AMAP International Symposium on Environmental Pollution in the Arctic. Extended abstracts. Vol. 1. Tromsø, Norway, June 1997.* pp. 210-212.
- Kvalem, H.E., Knutsen, H.K., Lorentzen, M.K., Sletta, A. (2009) Miljøgifter i matvarer på det norske markedet 2003 – 2005. Analyser av dioksiner, PCB og bromerte flammehemmere (PBDE og HBCD). URL: [http://www.mattilsynet.no/mattilsynet/multimedia/archive/00050/Milj\\_gifter\\_i\\_matvar\\_5\\_0189a.pdf](http://www.mattilsynet.no/mattilsynet/multimedia/archive/00050/Milj_gifter_i_matvar_5_0189a.pdf) [Accessed 31 January 2013].
- Lin, M., Chen, Y., Burnett, R.T., Villeneuve, P.J., Krewski, D. (2002) The influence of ambient coarse particulate matter on asthma hospitalization in children: Case-crossover and time-series analyses. *Environ. Health Perspect.*, 110, 575-581.
- Lukin, A., Dauvalter, V., Kashulin, N., Yakovlev, V., Sharov, A., Vandysh, O. (2003) Assessment of copper-nickel industry impact on a subarctic lake ecosystem. *Sci. Total Environ.*, 306, 73-83.
- Lyanguzova, I.V. (2011) Effect of industrial air pollution on wild plant seed germination and seedling growth. *Russ. J. Plant Physiol.*, 58, 991-998.
- Moiseenko, T.I. (1994) Acidification and critical loads in Surface Waters; Kola, Northern Russia. *Ambio*, 23, 418-424.
- Moiseenko, T.I., Kudryavtseva, L.P., Rodushkin, I.V., Lukin, A.A., Kashulin, N.A., Dauvalter, V.A. (1995) Airborne contaminants heavy metals and aluminium in the freshwater ecosystems on the Kola subarctic region, Russia. *Sci. Total Environ.*, 160-161, 715-727.
- Moiseenko, T.I. (1995) Critical load of SO<sub>4</sub> for surface waters in the Kola region of Russia. *Water Air Soil Pollut.*, 85, 469-473.
- Moiseenko, T.I., Kudryavtseva, L.P. (2001) Trace metal accumulation and fish pathologies in areas affected by mining and metallurgical enterprises in the Kola Region, Russia. *Environ. Pollut.*, 114, 285-297.
- Moiseenko, T.I., Kudryavtseva, L.P., Rodyushkin, I.V., Dauvalter, V.A., Lukin, A.A., Kashulin, N.A. (1995) Airborne contamination by heavy metals and aluminium in the freshwater ecosystems of the Kola Subarctic region (Russia). *Sci. Total Environ.*, 160-161, 715-727.
- Molvær, J., Knutzen, J., Magnusson, J., Rygg, B., Skei, J., Sørensen, J. (1997) Classification of environmental quality in fjords and coastal waters. Oslo, Norwegian Pollution Control Authority (SFT-Veiledning, 97:03). (In Norwegian).

- Mousavi, S.K., Primicerio, R., Amundsen, P.A. (2003) Diversity and structure of Chironomidae (Diptera) communities along a gradient of heavy metal contamination in a subarctic watercourse. *Sci. Total Environ.*, 307, 93-110.
- Myking, T. (2008) Content of heavy metals in cloudbberries and bilberries in Sør-Varanger, Finnmark 2008. Fylkesmannen i Finnmark, Miljøvernnavdelingen (RAPPORT, 3–2009). NATO/CCMS (1988) International toxicity equivalency factor (I-TEF) method of risk assessment for complex mixtures of dioxins and related compounds. Brussels, North Atlantic Treaty Organization (Report No.176).
- NIFES/Miljøstatus.no (2011) Forurensning i torsk. URL: <http://www.miljostatus.no/Tema/Hav-og-kyst/Barentshavet/Indikatorer-barentshavet/Forurensning-i-torsk/> [Accessed 30 October 2013].
- Nilsen, B.M., Frantzen, S., Julshamn, K. (2011) Fremmedstoffer i villfisk med vekt på kystnære farvann. En undersøkelse av innholdet av dioksiner og dioksinlignende PCB i torskelerver fra 15 fjorder og havner langs norskekysten 2009. Bergen, Nasjonalt institutt for ernærings- og sjømatforskning.
- Nilsen, P. (1995) Inland fishery in Finnmark County. Finnmarksforskning (Report 1995-005). (In Norwegian).
- Norconsult (2008) Kartlegging av forurensninger i sedimentet utenfor Kimek AS, Trinn 2 Risikovurdering. Rapport fra Norconsult, oppdrag nr. 5009358.
- Norton, S.A., Henriksen, A., Appelby, P.G., Ludwig, L.L., Vereault, D.V., Traaen, T. (1992) Trace metal pollution in Eastern Finnmark, Norway, as evidenced by studies of lake sediments. Oslo, NIVA (Statlig program forforurensningsovervåkning. Rapport 487/92. TA-836/1992) (NIVA-report 2727-1992).
- Nystad, W., Stensrud, T., Rijcken, B., Hagen, J., Magnus, P., Carlsen, K.H. (1999) Wheezing in school children is not always asthma. *Pediatr. Allergy Immunol.*, 10, 58-65.
- OSPAR (2000) OSPAR Commission 2000. Quality Status Report 2000. London, OSPAR Commission.
- Pasanen, K., Pukkala, E., Turunen, A.W., Patama, T., Jussila, I., Makkonen, S., Salonen, R.O., Verkasalo, P.K. (2012) Mortality among population with exposure to industrial air pollution containing nickel and other toxic metals. *J. Occup. Environ. Med.*, 54, 583-591.
- Pasvik programme (2008) Pasvik programme. Publications. URL: [http://www.pasvikmonitoring.org/eng/PUBLICATIONS\\_2003-2011/publications\\_2003-2011.html](http://www.pasvikmonitoring.org/eng/PUBLICATIONS_2003-2011/publications_2003-2011.html) [Accessed 30 October 2013].
- Pub Med Health (2013) Asthma. URL: <http://www.ncbi.nlm.nih.gov/pubmedhealth/PMH0001196/> [Accessed 18 January 2013].
- Puro-Tahvanainen, A., Luokkanen, E. (2007) Water quality of small lakes and streams in the Finnish, Norwegian and Russian border area. In: *State of the Environment in the Norwegian, Finnish and Russian Border area*. Ed. by: Stebel, K., Christensen, G., Derome, J., Grekelä, I. Rovaniemi, Lapland Regional Environment Centre (The Finnish Environment 6/2007).
- Puro-Tahvanainen, A., Grekelä, I., Derome, J., Stebel, K. (eds.) (2008) Environmental monitoring programme in the Norwegian, Finnish and Russian border area – Implementation guidelines. Rovaniemi, Lapland Regional Environment Centre, Finland. Office of the Finnmark County Governor, Norway. Murmansk Departement for Hydrometeorology and Environment Monitoring, Russia.

- Puro-Tahvanainen, A., Zueva, M., Kashulin, K., Sandimirov, S., Christensen, G.N., Grekelä, I. (2011) Pasvik water quality report. Environmental monitoring programme in the Norwegian, Finnish and Russian border area. Rovaniemi, Centre for Economic Development, Transport and the Environment for Lapland (Publications, 7/2011).
- Reimann, C., Niskavaara, H., de Caritat, P., Finne, T.E., Ayras, M., Chekushin, V. (1996) Regional variation of snowpack chemistry in the vicinity of Nikel and Zapoljarnij, Russia, Northern Finland and Norway. *Sci. Total Environ.*, 182, 147-158.
- Reimann, C., Niskavaara, H., de Caritat, P., Äyräs, M., Chekushin, V.A., Finne, T.E. (1995) Snowpack sampling used to fingerprint environmental contamination in the surroundings of the nickel smelter at Nikel, Kola Peninsula. In: Heavy metals in the Environment. International Conference, Hamburg, Sept. 1995. Ed. by: Wilken R.D., Förstner, U., Knöchel, A. (Eds.). CEP-Consultants, Edinburgh, pp. 84-87.
- Reimann, C., Äyräs, M., Chekushin, V., Bogatyrev, I., Boyd, R., Caritat, P., de Dutter, R., Finne, T.E., Halleraker, J.H., Jæger, Ø., Kashulina, G., Lehto, O., Niskavaara, H., Pavlov, V., Räisänen, Strand, T., Volden, T. (1998) Environmental geochemical atlas of the central Barents region. Trondheim, Geological Survey of Norway (NGU-GTK-CKE special publication).
- Reimann, C., Banks, D., Bogatyrev, I., de Caritat, P., Kashulina, G., Niskavaara, H. (1999) Lake water geochemistry on the western Kola Peninsula, north-west Russia. *Appl. Geochem.*, 14, 787-805.
- Rognerud, S., Fjeld, E. (2001) Trace element contamination of Norwegian lake sediments. *Ambio*, 30, 11-19
- Rognerud, S., Dauvalter, V.A., Fjeld, E., Skjelkvåle, B.L., Christensen, G., Kashulin, N. (2013) Spatial trends of trace-element contamination in recently deposited lake sediment around the Ni-Cu smelter at Nikel, Kola Peninsula, Russian Arctic. *Ambio*, 42, 724-736.
- Rognerud, S., Skotvold, T., Fjeld, E., Norton, S.A., Hobæk, A. (1998) Concentrations of trace elements in recent and preindustrial sediments from Norwegian and Russian Arctic lakes. *Can. J. Fish. Aquat. Sci.*, 55, 1512-1523.
- Savinov, V., Savinova, T.N., Matishov, G.G., Dahle, S., Næs, K. (2003) Polycyclic aromatic hydrocarbons (PAHs) and organochlorines (OCs) in bottom sediments of the Guba Pechenga, Barents Sea, Russia. *Sci. Total Environ.*, 306, 39-56.
- Schartau, A.K., Fjellheim, A., Walseng, B., Skjelkvåle, B.L., Halvorsen, G.A., Skancke, L.B., Saksgård, R., Manø, S., Solberg, S., Jensen, T.C., Høgåsen, T., Hesthagen, T., Aas, W., Garmo, Ø. (2011) Monitoring long-range transboundary air pollution. Effects 2010. Oslo, NIVA (Statlig program for forurensningsovervåking. Rapport 1094/2011. TA-2793/2011) (NIVA-rapport 6214-2011) (In Norwegian).
- Schlabach, M., Skotvold, T. (1996) Measurement of PCDD/PCDF around the pellet's factory of Aktieselskabet Sydvaranger. Kjeller, NILU (NILU, OR 11/96) (In Norwegian).
- Selnes, A., Odland, J.O., Bolle, R., Dotterud, L.K., Lund, E. (2001) Asthma and allergy in Russian and Norwegian schoolchildren: results from two questionnaire-based studies in the Kola Peninsula, Russia, and northern Norway. *Allergy*, 56, 344-348.
- SFT (2002) Air pollution effects in the Norwegian - Russian border area. A status report. Oslo, Norwegian Pollution Control Authority (TA-1860/2002).
- Shah, R., Grammer, L. (2012) An overview of allergens. *Allergy Asthma Proc.*, 33, S1-S5.

- Sidorov, V.S., Popova, R.A. (1978) Fish lipid content depending on habitat alteration was caused by anthropogenic factors. *Ekologicheskaya biokhimiya Zhivotnih* (Ecological biochemistry of animals). Petrozavodsk, Karelian branch Academy of Science USSR. pp. 6-14.
- Sivertsen, B., Hagen, L O., Hellevik, O., Henriksen, J F. (1991) Air pollution in the border areas of Norway/Soviet Union. January 1990–March 1991. Lillestrøm, NILU (Statlig program for forurensningsovervåking. Rapport 480/92. TA-815/1992) (NILU OR, 69/91). (In Norwegian).
- Skjelkvåle, B.L. (ed.) (2001) Monitoring long-range transboundary air pollution. Effects 2000. Oslo, NIVA (Statlig program for forurensningsovervåking. Rapport 834/01. TA-1830/2001). (In Norwegian).
- Skjelkvåle, B.L., Rognerud, S., Fjeld, E., Christensen, G.N., Røyset, O. (2008) National lake survey 2004-2006, Part 1: Water chemistry. Status of acidification, nutrients and metals. Oslo, NIVA ( TA-2361/2008) (In Norwegian).
- Skjelkvåle, B.L., Aherne, J., Bergman, T., Bishop, K., Forsius, M., Forrström, L., Gashkina, N. A., Hetterlingh, J.-P., Jeffries, D., Kaste, Ø., Korhola, A., Lappalainen, A., Laudon, H., Mannio, Moiseenko, T., Nyman, M., Posch, M., Schartan, A. K., Stoddard, J., Tammi, J., Vuorenmaa, J, Wilander, A., Yakovlev, V. (2006) Effects on freshwater ecosystems. In: *AMAP Assessment 2006: Acidifying Pollutants, Arctic Haze and Acidification in the Arctic*. Oslo, Arctic Monitoring and Assessment Programme (AMAP). pp. 64-90.
- Skjelkvåle, B.L., Kashulin, N., Dauvalter, V., Christensen, G.N., Rognerud, S., Garmo, Ø., Lund, E. (2013) Status and trends in metal concentrations and acidification in lakes in the border area between Russia and Norway 1990 – 2010. Oslo, NIVA (NIVA-rapport 6461-2012). (In press).
- Skotvold, T., Savinov, V. (2003) Regional distribution of PCBs and presence of technical PCB mixtures in sediments from Norwegian and Russian Arctic Lakes. *The Sci. Total Environ.*, 306, 85-97.
- Skotvold T., Wartena, E., Rognerud S. (1997) Heavy metals and persistent organic pollutants in sediments and fish from lakes in Northern and Arctic regions of Norway. Tromsø, Akvaplan-niva (Statlig program for forurensningsovervåking. Rapport 688/97. TA-1427/1997) (Akvaplan-niva report, APN514.660.1).
- Skotvold, T., Schlabach, M. (1997) PCDD/PCDF innsjø-sedimenter på Varangerhalvøya og Kolahalvøya. Tromsø, Akvaplan-niva (Statlig program for forurensningsovervåking. Rapport 687/97) (Akvaplan-niva Rapport, 514.974).
- Smith-Sivertsen, T., Bykov, V., Melbye, H., Tchachtchine, V., Selnes, A., Lund, E. (2001) Sulphur dioxide exposure and lung function in a Norwegian and Russian population living close to a nickel smelter. *Int. J. Circumpolar Health.*, 60, 342-359.
- Smith-Sivertsen, T., Tchachtchine, V., Lund, E. (2000) Self-reported airway symptoms in a population exposed to heavy industrial pollution: what is the role of public awareness? *Epidemiology*, 11, 739-40.
- Smith-Sivertsen, T., Tchachtchine, V., Lund, E., Bykov, V., Thomassen, Y., Norseth, T. (1998) Urinary nickel excretion in populations living in the proximity of two russian nickel refineries: a Norwegian-Russian population-based study. *Environ Health Perspect.*, 106, 503-511.

- Smith-Sivertsen, T., Tchachtchine, V., Lund, E., Norseth, T., Bykov, V. (1997) The Norwegian - Russian Health Study 1994/95. A cross-sectional study of pollution and health in the border area. Tromsø, Universitetet i Tromsø (ISM Skriftserie, 42.).
- Smith-Sivertsen, T., Dotterud, L.K., Lund, E. (1999) Nickel allergy and its relationship with local nickel pollution, ear piercing, and atopic dermatitis: a population-based study from Norway. *J. Am. Acad. Dermatol.*, 40, 726-735.
- Smith-Sivertsen, T. (2000) Air pollution and health in the Norwegian-Russian border area. A cross-sectional population-based study of the impact of nickel and sulphur dioxide. Tromsø, Universitetet i Tromsø (ISM Skriftserie, 55).
- Sparling, D.W., Lowe, T.P. (1996) Environmental hazards of aluminium to plants, invertebrates, fish, and wildlife. *Rev. Environ. Contam.Toxicol.*, 145, 1-127.
- Stebel, K., Christensen, G.N., Derome, J., Grekelä, I. (eds.) (2007) State of the environment in the Norwegian, Finnish and Russian border area. Rovaniemi, Lapland Regional Environment Centre (The Finnish Environment 6/2007).
- Steinnes, E., Lukina, N., Nikonov, V., Aamlid, D., Røyseth, O. (2000) A gradient study of 34 elements in the vicinity of a copper-nickel smelter at the Kola Peninsula. *Environ. Monit. Assess.*, 60, 71-88.
- Steinnes, E., Berg, T., Uggerud, H.T. (2011a) Three decades of atmospheric metal deposition in Norway as evident from analysis of moss samples. *Sci.Total Environ.*, 412-413, 351-358.
- Steinnes, E., Berg, T., Uggerud, H.T., Pfaffhuber, K.A. (2011b) Atmospheric deposition of heavy metals in Norway. Nationwide survey 2010. Kjeller, NILU (Statlig program for forurensningsovervåking. Rapport 1109/2011. TA-2859/2011) (NILU OR, 60/2011) (In Norwegian).
- Sterling, Y.M. (2012) Impact of the environment on asthma control. *J. Community Health Nurs.*, 29, 143-153.
- Surinin, V.A., Kovnatsky, E.G., Lobov, A.J., Vasilenko, V.N., Belikova, T.V., Nazarov, I.M., Bezuglaya, E.Y. (1997) Environmental impacts of the atmospheric emissions of the smelters at Norilsk, Central Siberia. In: *The AMAP International Symposium on Environmental Pollution in the Arctic. Extended abstracts. Vol. 1. Tromsø, Norway, June 1997.* pp. 191-194.
- Symon, C. (2008) Pasvik Programme - Summary Report 2008. State of the environment in the Norwegian, Finnish and Russian border area. Vadsø, Office of the Finnmark County Governor (Report 1 - 2008).
- Tammaro, A., Narcisi, A., Persechino, S., Caperchi, C., Gaspari, A. (2011) Topical and systemic therapies for nickel allergy. *Dermatitis*, 22, 251-255.
- Traaen, T.S., Henriksen, A., Moiseenko, T., Wright, R.F. (1992) Lake monitoring, critical load of sulphur and modelling of future acidity for several sulphur reduction scenarios in the Norwegian-Russian border areas. In: *State of Environment and Environmental Monitoring in Northern Fennoscandia and the Kola Peninsula.* Ed. by: Tikkanen, E. Rovaniemi, Varmola, M., Katermaa, T. University of Lapland (Arctic Centre Publications. 4). pp. 161-164.
- Traaen, T.S., Moiseenko, T., Dauvalter, V., Rognerud, S., Henriksen, A., Kudravseva, L. (1991) Acidification of surface waters, nickel and copper in water and lake sediments in the Russian-Norwegian border areas. Progress report for 1989-1990. Oslo and Apatity,



Working Group for Water and Environmental Problems under the Norwegian-Soviet Environmental Protection Commission.

Tømmervik, H., Høgda, K.A., Solheim, L. (2003) Monitoring vegetation changes in Pasvik (Norway) and Pechenga in Kola Peninsula (Russia) using multitemporal Landsat MSS/TM data. *Rem. Sens. Environ.*, 85, 370-388.

Tømmervik, H., Johansen, M.E., Pedersen, J.P., Guneriussen, T. (1998) Integration of remote sensed and in-situ data in an analysis of the air pollution effects on terrestrial ecosystems in the border areas between Norway and Russia. *Environ. Monit. Assess.*, 49, 51-85.

Vancouver Island Health Authority (2013) James Bay Sulphur Dioxide Monitoring Program 2011-2013 - Health risk guide. URL: [http://www.viha.ca/mho/james\\_bay\\_sulphur\\_dioxide\\_monitoring.htm](http://www.viha.ca/mho/james_bay_sulphur_dioxide_monitoring.htm) [Accessed 25 January 2013].

WHO (2006) WHO Air quality guidelines for particulate matter, ozone, nitrogen dioxide and sulfur dioxide - global update 2005. Summary of risk assessment. Geneva, World Health Organization.

WHO (2011) Global atlas on cardiovascular disease prevention and control. Ed. by: Mendis, S., Puska, P., Norrving, B. Geneva, World Health Organization.

Aamlid, D., Skogheim, I. (1993) Nikkel, kopper og andre metaller i multer og blåbær fra Sør-Varanger, 1992. Ås, Skogforsk (Rapport fra Skogforsk, 14/93).

#### **EMEP reports**

Hjellbrekke, A.-G., Fjæraa, A.M. (2012) Data report 2010. Acidifying and eutrophying compounds and particulate matter. Kjeller, NILU (EMEP/CCC, 01/2012).

Hjellbrekke, A.-G., Solberg, S., Fjæraa, A.M. (2012) Ozone measurements 2010. Kjeller, NILU (EMEP/CCC, 02/2012).

Aas, W., Breivik, K. (2012) Heavy metals and POP measurements, 2010. Kjeller, NILU (EMEP/CCC, 03/2012).

Solberg, S. (2012) VOC measurements 2010. Kjeller, NILU (EMEP/CCC, 04/2012).

All EMEP reports are available at:

<http://www.nilu.no/projects/ccc/reports.html> [Accessed 31 January 2013]



## **Appendix A**

Additional information about the air and precipitation quality in the border areas.



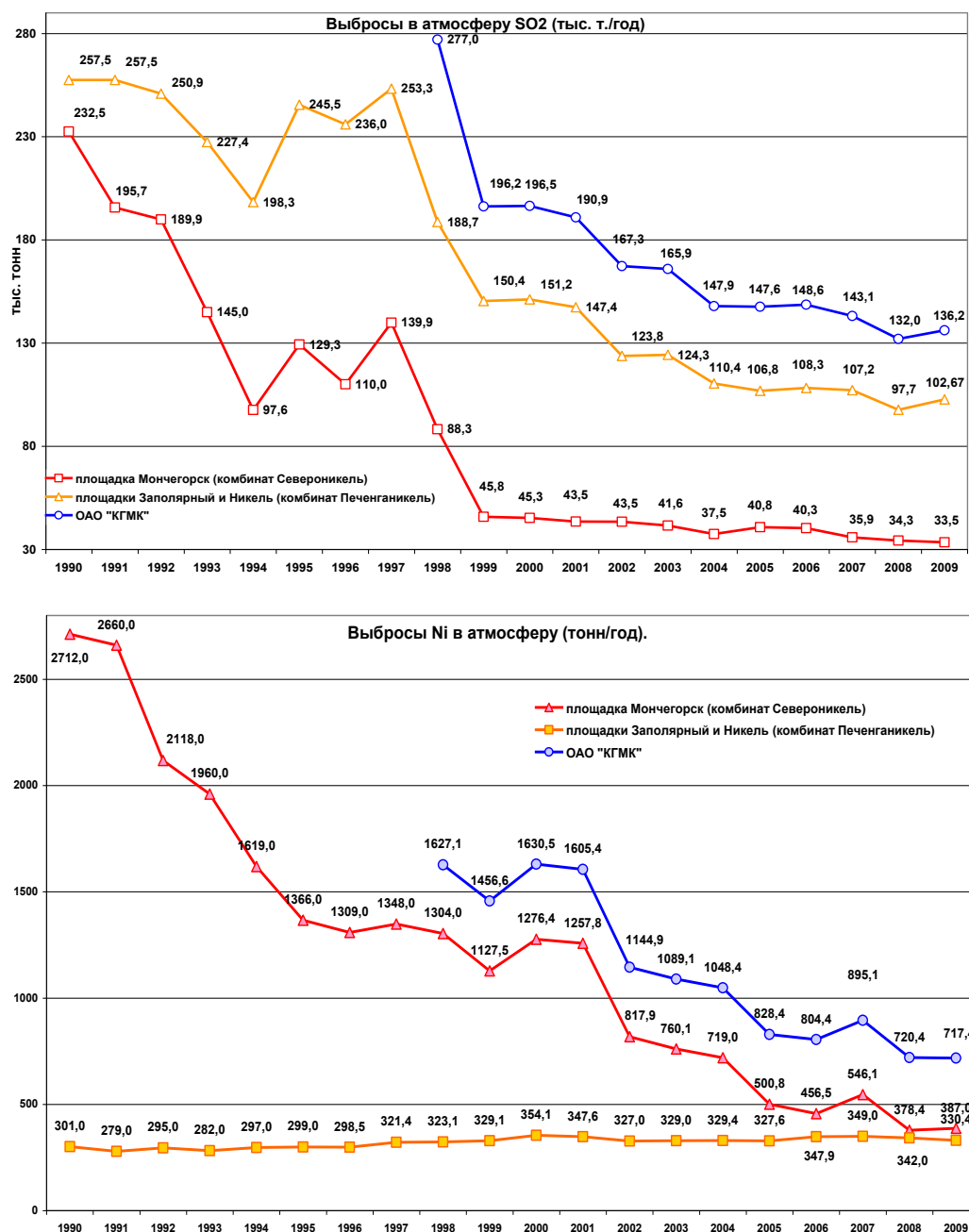
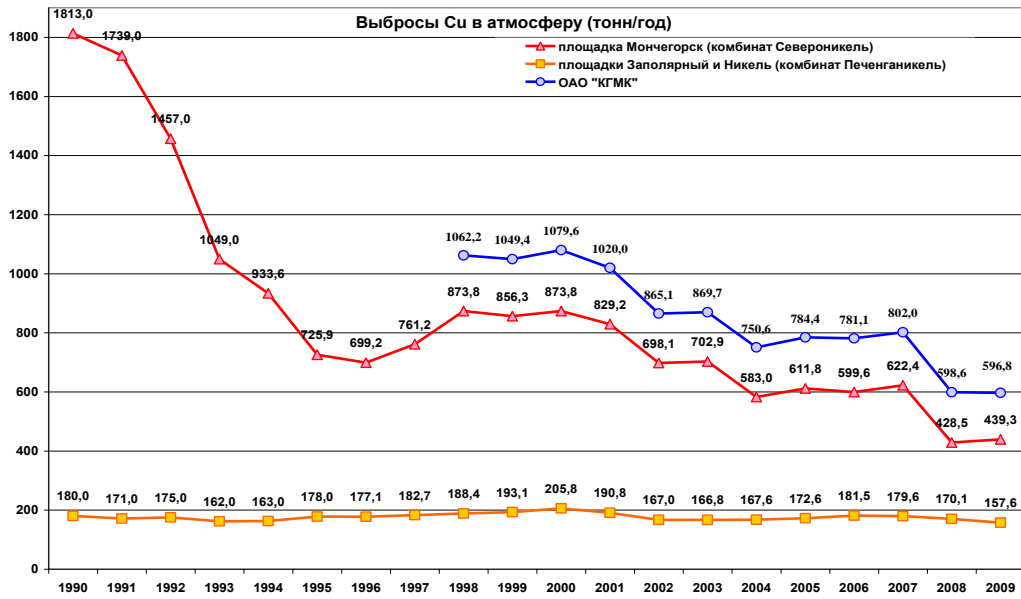


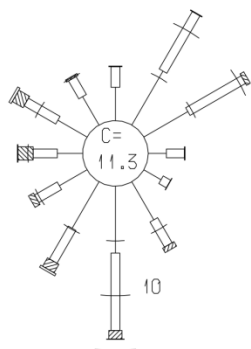
Figure A.1.: Emission inventory provided by Kola MMC (subsidiary of Norilsk-Nickel), emissions of SO<sub>2</sub> (upper panel), Ni (lower panel) and Cu (next page). Orange curve show emissions from Pechenganikel (Nikel and Zapolyarny), red curve shows emissions from Severonikel (Monchegorsk) and blue curve is the sum of the two. Unit thousand tonnes/year for SO<sub>2</sub> and tonnes/year for elements.<sup>11</sup>

<sup>11</sup> For further details, see [http://www.nornik.ru/en/our\\_products/kola\\_mmc/](http://www.nornik.ru/en/our_products/kola_mmc/). [ACCESSED 31-01-2013]

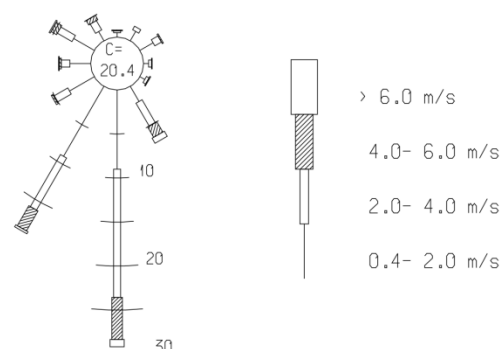


*Figure cont'd: Emission inventory provided by Kola MMC.*

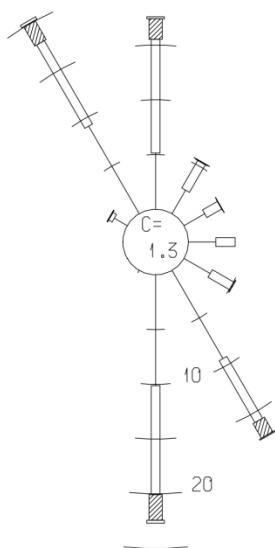
Stasjon: Svanvik  
Periode: 1.4.11 - 30.9.11



Stasjon: Svanvik  
Periode: 1.10.11 - 31.3.12



Stasjon: Karpdalen  
Periode: 1.4.11 - 30.9.11



Stasjon: Karpdalen  
Periode: 1.10.11 - 31.3.12

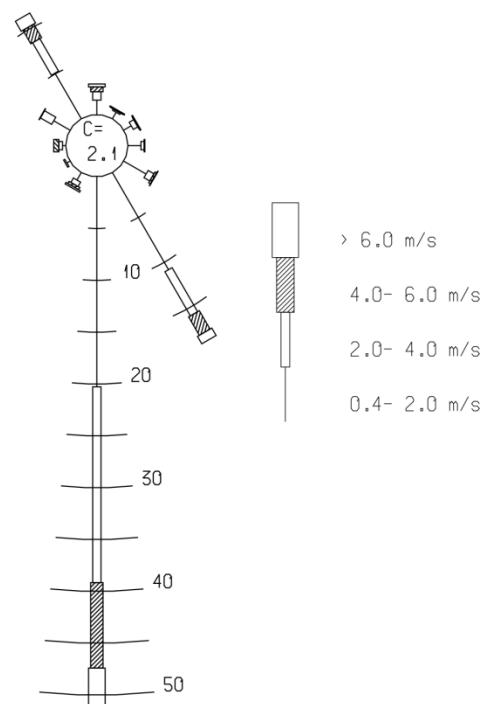


Figure A2: Wind roses for Svanvik and Karpdalen, April-September 2011 and October 2011-March 2012 (they show the frequency of the wind in 12 30°-sectors, i.e. how often the wind is coming **from** these directions). C indicates percentage of no wind. There are more calm conditions in winter time, C=11,4% in summer and C=20,4% in winter. This is because of less sun, and hence less energy to the atmosphere during the polar winter.

### Other networks, Finland;

It should also be mentioned that Finland (FMI) participates in the GAW network (Global Atmospheric Watch) coordinated by WMO (World Meteorological Organization)<sup>12</sup>. The Arctic Research Centre and the Pallas Atmospheric Research station together form the Pallas-Sodankylä GAW station<sup>13</sup>. Upper-air soundings, synoptic measurements, total ozone observations and ozone soundings are taken at Sodankylä and tropospheric air composition and related boundary-layer meteorology measurements at Pallas.

Pallas-Sodankylä GAW site also forms a satellite calibration-validation test area. Sodankylä FTIR (Fourier Transform Infrared Spectroscopy) station has been operational from the beginning of 2009. The station is part of TCCON (Total Carbon Column Observing Network) network. The primary FTIR product is column amount of CO<sub>2</sub> and other important GHGs such as CH<sub>4</sub> and N<sub>2</sub>O. This station also reports data to ICOS (Integrated Carbon Observation System), a European infrastructure network<sup>14</sup>.

### Toxic elements in air

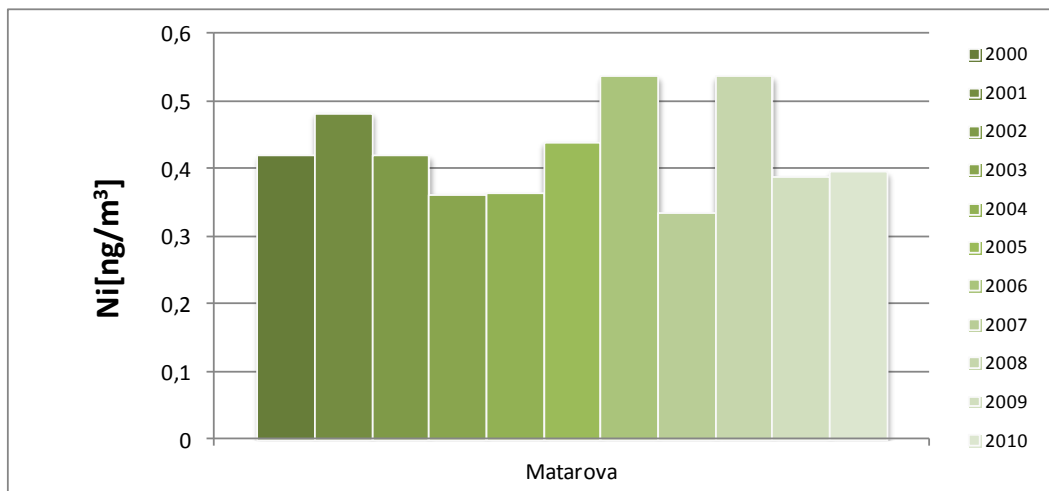


Figure A3: Annual mean concentrations of Ni in air at Matarova, Finland. Unit: ng/m<sup>3</sup>.

<sup>12</sup> [http://www.wmo.int/pages/prog/arep/gaw/gaw\\_home\\_en.html](http://www.wmo.int/pages/prog/arep/gaw/gaw_home_en.html) [ACCESSED 31-01-2013]

<sup>13</sup> <http://fmigaw.fmi.fi/> [ACCESSED 31-01-2013]

<sup>14</sup> [http://www.icos-infrastructure.fi/index.php?option=com\\_content&view=article&id=5&Itemid=9](http://www.icos-infrastructure.fi/index.php?option=com_content&view=article&id=5&Itemid=9) [ACCESSED 31-01-2103]



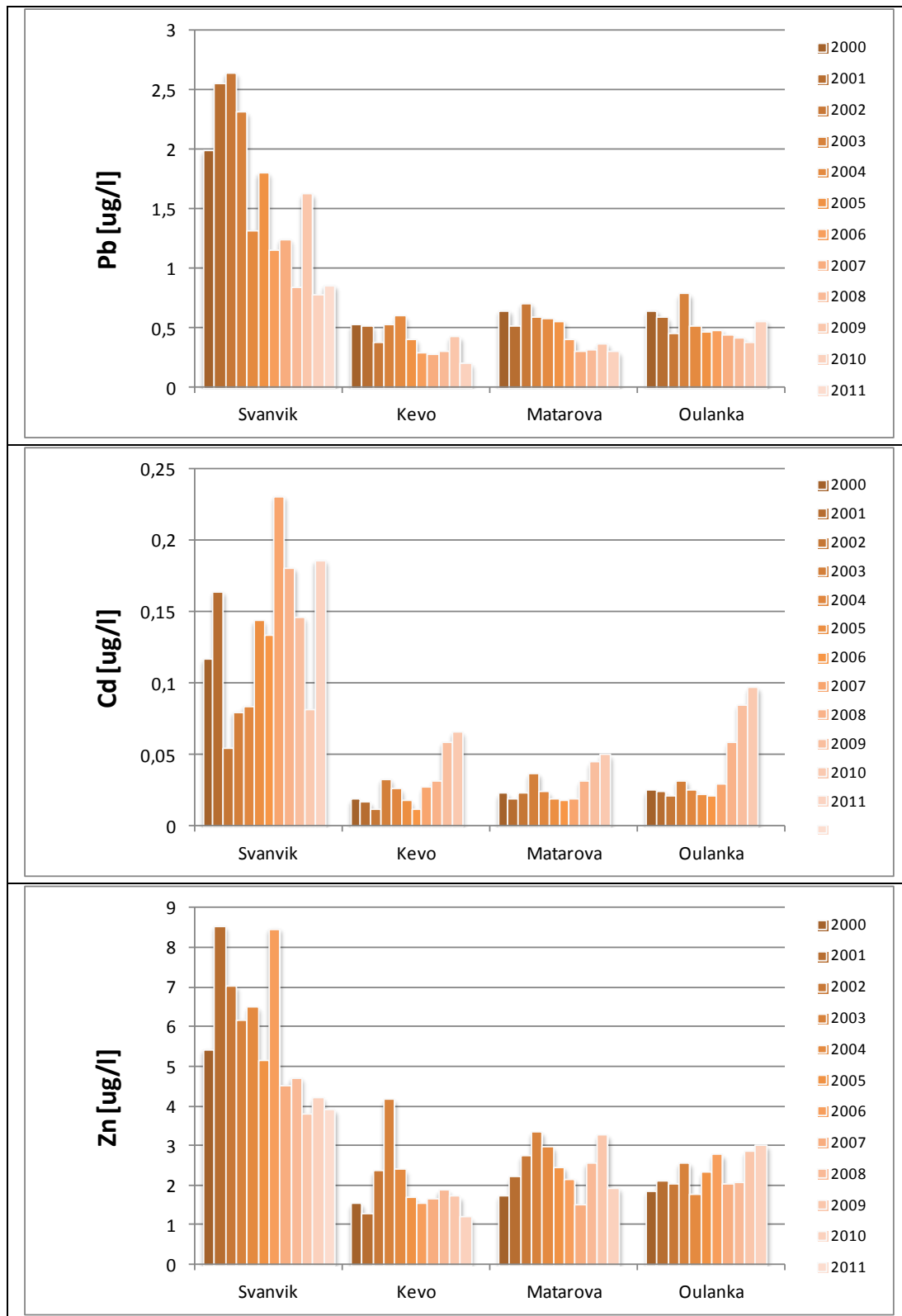


Figure A4: Annual mean concentrations of toxic elements in precipitation for Svanvik and three Finnish EMEP stations. Unit µg/l.

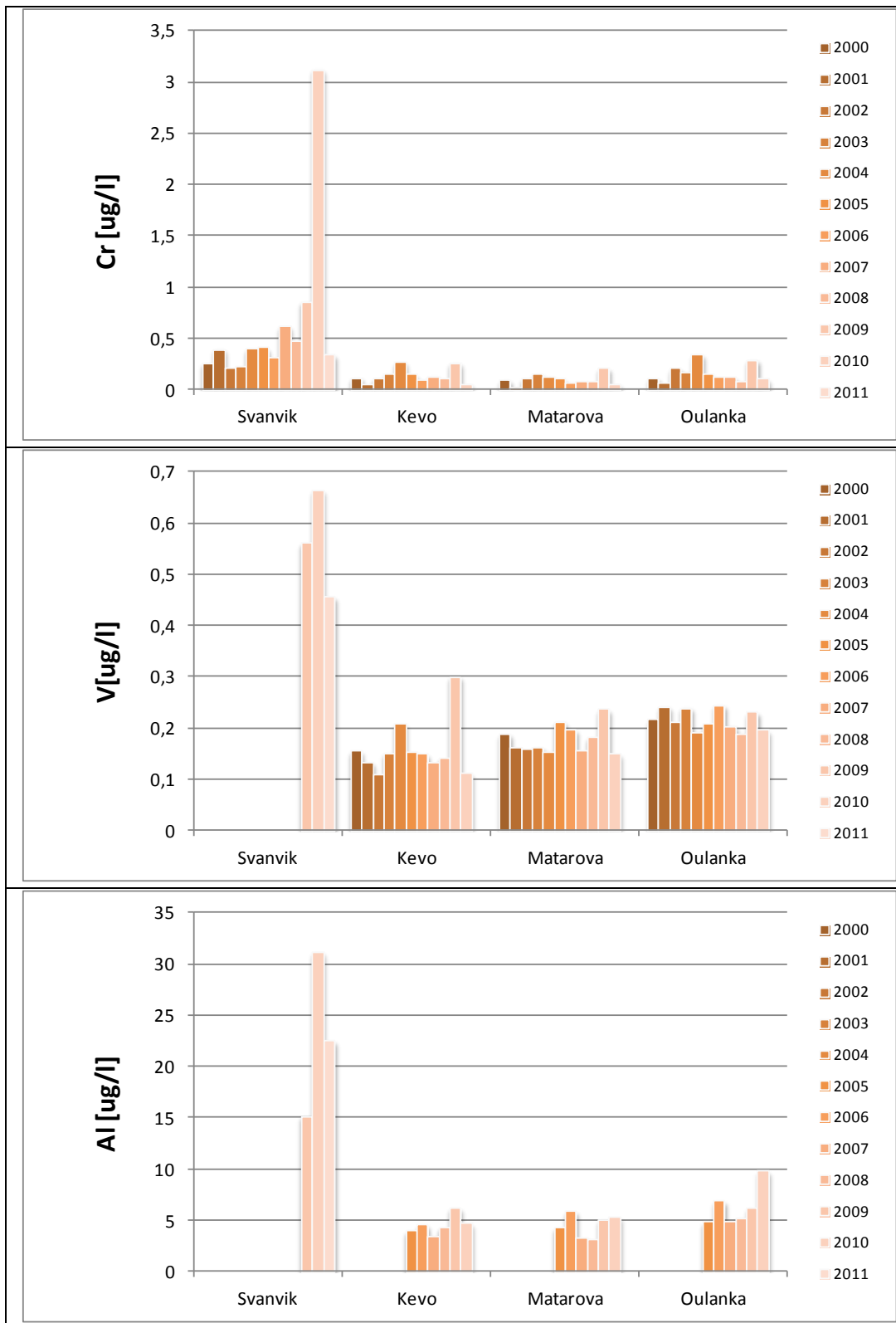


Figure cont'd: Annual mean concentrations



**Norwegian Institute  
for Air Research**

NILU – Norwegian Institute for Air Research  
P.O. Box 100, N-2027 Kjeller, Norway  
*Associated with CIENS and the Fram Centre*  
*ISO certified according to NS-EN ISO 9001/ISO 14001*

REPORT SERIES Scientific report	REPORT NO. OR 40/2013	ISBN: 978-82-425-2606-9 (print) 978-82-425-2609-0 (electronic)	
DATE 2013-11-01	SIGN. <i>de-Anders Braathen</i>	NO OF PAGES 88	PRICE NOK 150,-
TITLE Health and environmental impacts in the Norwegian border area related to local Russian industrial emissions		PROJECTLEADER Eldbjørg Sofie Heimstad	
		NILU PROJECT NO. O-112132	
AUTHOR(S) Torkjel M. Sandanger (UiT/NILU), Erik Anda (UiT), Tore F. Berglen (NILU), Anita Evenset (Akvaplan-niva), Guttorm Christensen (Akvaplan-niva) and Eldbjørg S. Heimstad (NILU)		CLASSIFICATION * A	
		CONTRACT REF.	
QUALITY CONTROLLER:			
REPORT PREPARED FOR: Miljøverndepartementet			
KEYWORDS Russia	Emissions	Norwegian border	
NORWEGIAN TITLE			
ABSTRACT The contaminant situation in the Norwegian-Russian border has caused concern for several decades and considerable amount of data has been gathered during the Pasvik programme (Stebel <i>et al.</i> , 2007; Pasvik programme, 2008) for the environmental pollution, but not in this extent for food safety and potential human health risks in this region. Through the compiling of the available literature the authors of this report have identified a number of issues that need further attention.			

\* CLASSIFICATION    A    *Unclassified (can be ordered from NILU)*  
                                  B    *Restricted distribution*  
                                  C    *Classified (not to be distributed)*

REFERENCE: O-112132  
DATE: OCTOBER 2013  
ISBN: 978-82-425-2606-9 (print)  
978-82-425-2609-0 (electronic)

NILU – Norwegian Institute for Air Research is an independent, nonprofit institution established in 1969. Through its research NILU increases the understanding of climate change, of the composition of the atmosphere, of air quality and of hazardous substances. Based on its research, NILU markets integrated services and products within analyzing, monitoring and consulting. NILU is concerned with increasing public awareness about climate change and environmental pollution.