

NILU : OR 40/99  
REFERENCE : O-2008  
DATE : SEPTEMBER 1999  
ISBN : 82-425-1099-7

**Update of model  
calculations for a planned  
aluminium smelter at  
Hraun, Iceland**

**Cristina Guerreiro**

# Contents

	Page
<b>Summary</b> .....	<b>3</b>
<b>1. Introduction</b> .....	<b>7</b>
<b>2. Proposed air quality guidelines</b> .....	<b>8</b>
<b>3. Meteorological conditions</b> .....	<b>9</b>
3.1 Wind speed and wind direction .....	9
3.2 Stability.....	12
3.3 Meteorological matrixes for dispersion calculations .....	15
<b>4. Emission data</b> .....	<b>16</b>
<b>5. Model calculations of long term average concentrations</b> .....	<b>22</b>
5.1 Sulphur dioxide.....	22
5.2 Gaseous fluorides.....	26
<b>6. Typical day with high impact of the smelter's emissions</b> .....	<b>32</b>
6.1 Sulphur dioxide.....	32
6.2 Gaseous fluorides.....	39
<b>7. Model calculations for PM10</b> .....	<b>43</b>
7.1 Long term average concentration .....	43
7.2 Typical day with high impact of the smelter's emissions.....	44
<b>8. Conclusions</b> .....	<b>45</b>
<b>9. References</b> .....	<b>47</b>
<b>Appendix A Statistics for the wind speed and wind direction at Hraun</b> .....	<b>49</b>

## Summary

The Norwegian Institute for Air Research (NILU) has been asked by Norsk Hydro Produksjon A.S. to carry out a comparison of recent meteorological measurements at Hraun in Reydarfjörður with measurements at Mjöeyri in Eskifjörður, in the eastern part of Iceland, and update the model calculations for a planned aluminium smelter at Hraun using the meteorological measurements at Hraun.

The dispersion model calculations for the planned aluminium smelter have been done in order to assess the potential dispersion of sulphur dioxide, fluorides and PM10 for four production alternatives: 120,000 (ALT. 1), 240,000 (ALT. 2), 360,000 (ALT. 3) and 480,000 (ALT. 4) tons of aluminium per year. Calculations have been done for these four alternatives with a dry scrubber and with both a dry and a wet scrubber, using the anticipated design values for the smelter emissions. Finally emissions from the various production alternatives have been calculated according to The Oslo and Paris Commission (PARCOM) definition of Best Available Technology (BAT) and its emission guidelines for new prebake lines built after 1999. The objective of the dispersion calculations has been to assess whether the relevant air quality guidelines are met.

Recent measurements of wind and temperatures have been carried out by the meteorological office in Reykjavik at Hraun in Reydarfjörður, between the 1 May 1998 and the 31 of May 1999. These recent meteorological measurements are compared with measurements carried out in 1984 in the same area, but at different locations. The recent meteorological measurements taken at Hraun have been used to update the dispersion calculations.

NILU has carried out a statistical evaluation of 10 min. averaged wind measurements at Hraun in period from May 1998 to May 1999 and compared with wind measurements at Somastadagerdi measured between December 1982 and December 1984. The wind measurements carried out at Somastadagerdi are comparable with the recent wind measurements at Hraun. Both measurement years/ stations show a strong channelling effect along the east-west oriented valley axis (ca. 41% at Hraun and ca. 39% at Somastadagerdi). The average wind speed for one year was 4.5 m/s at Hraun and 4.1 m/s at Somastadagerdi. The predominant wind was down valley winds from west (about 24% of time at Hraun and about 20% of the time at Somastadagerdi). Onland winds (sea breeze) from east occurred in about 17% of time at Hraun and about 19% of time at Somastadagerdi, mostly during daytime hours.

The stability measurements carried out at Mjöeyri in Eskifjörður and used in previous dispersion calculations have overestimated the occurrence of stable conditions during daytime hours in the summer and unstable conditions during the winter period. The recent stability measurements carried out at Hraun in Reydarfjörður seem to give a good description of the stability conditions where the planned aluminium factory will be built and were used to update the dispersion calculations.

An update of the model calculations has been performed for SO<sub>2</sub> during one year and for a typical day with high impact of pollution from the smelter at Budareyri. The model calculations for fluorides during the growing season were also updated, and new calculations have been carried out for fluorides on a typical day with poor dispersion conditions. Taking into account the uncertainties in performing dispersion estimates such as source definition, plume rise, building effects, dispersion parameters, topography, etc., the following conclusions can be drawn:

- The *one year averaged SO<sub>2</sub>* concentration, due to emissions from the planned smelter, will not exceed the EU air quality guideline (20 µg/m<sup>3</sup>) outside the smelter industrial area for ALT. 1b, ALT. 2b and ALT. 3b with wet scrubber and for ALT. 1b without wet scrubber. ALT. 4b with wet scrubber and ALT. 2b without wet scrubber may exceed the EU guideline up to 0.5 km and 1.0 km west and 0.5 km and 0.9 km east from the smelter, respectively.
- Dispersion calculations of *gaseous fluorides for the growing season* showed that the Norwegian air quality guideline for vegetation (0.3 µg/m<sup>3</sup>) might be exceeded up to about:
  - 2 km, 3.2 km, 4.5 km and 9.5 km west of the smelter and up to about 1.3 km, 2.5 km, 3.5 km and 4.5 km east of the smelter for the PARCOM /BAT ALT. 1a, ALT. 2a, ALT. 3a and ALT. 4a, respectively;
  - 0.8 km, 1.5 km, 2.0 km and 2.7 km west of the smelter and up to about 0.5 km, 1.2 km, 1.5 km and 2.1 km east of the smelter for ALT. 1b, ALT. 2b, ALT. 3b and ALT. 4b with wet scrubber, respectively;
  - 1 km and 2.1 km west of the smelter and up to about 0.8 km and 1.5 km east of the smelter for ALT. 1b and ALT. 2b without wet scrubber, respectively.
- The calculated *total fluorides average for 6 months* exceeded the Norwegian air quality guideline for human health (10 µg/m<sup>3</sup>) up to 0.4 km, 0.5 km and 0.5 km west and 0.3 km, 0.4 km and 0.4 km east from the smelter buildings for the PARCOM /BAT ALT. 2a, ALT. 3a and ALT. 4a, respectively.
- On *a typical day with unfavourable meteorological conditions for the population in Budareyri and with high SO<sub>2</sub> emissions*, the Icelandic guideline (50 µg/m<sup>3</sup>) may be exceeded up to about 3 km, 5 km, 6,5 km and 7,8 km west of the smelter for ALT. 1a, ALT. 2a, ALT. 3a and ALT. 4a, respectively. The Icelandic air quality guideline of 50 µg/m<sup>3</sup> for 24 hour SO<sub>2</sub> concentrations can be exceeded up to 2% of the time. The probability of occurrence of a day with similarly adverse meteorological and emission conditions is less than 0.003%.
- On *a typical day with unfavourable meteorological conditions for the population in Budareyri and with normal SO<sub>2</sub> emissions*, the Icelandic guideline (50 µg/m<sup>3</sup>) may be exceeded up to about 0,5 km, 1,5 km and 2,5 km west of the smelter for ALT. 2b, ALT. 3b and ALT. 4b with wet scrubber, respectively, and up to about 2 km and 4 km west of the smelter for ALT. 1b and ALT. 2b without wet scrubber, respectively. Only ALT. 2b without wet

scrubber may reach concentrations around  $50 \mu\text{g}/\text{m}^3$  at Budareyri's eastern border. The Icelandic air quality guideline of  $50 \mu\text{g}/\text{m}^3$  for 24 hour  $\text{SO}_2$  concentrations can be exceeded up to 2% of the time. The probability of exceedance of  $50 \mu\text{g}/\text{m}^3$  in Budareyri is well under 2%.

- ***On a typical day with high fluoride emissions from the smelter and poor dispersion conditions***, the Norwegian air quality guideline for human health ( $25 \mu\text{g}/\text{m}^3$ ) may be exceeded in a restricted area outside the smelter area for ALT. 2, ALT. 3 and ALT. 4. The Norwegian air quality guideline for vegetation ( $1 \mu\text{g}/\text{m}^3$ ) may be exceeded, in such a day, up to about 2 km, 3.0 km, 3.5 km and 3.8 km west of the smelter, and up to about 2.3 km, 3.5 km, 4.0 km and 4.5 km east of the smelter, for ALT. 1, ALT. 2, ALT. 3 and ALT. 4, respectively. The situation with high emissions of fluorides may occur 1 to 4 times a year for only a few hours each time.

Particulate matter under  $10 \mu\text{m}$  (PM10) has been assessed for the largest production alternative in order to identify if emissions of PM10 would meet the ambient air quality guidelines for all the alternatives. Calculations were done for one year and for a typical day with high impact of pollution from the smelter at Budareyri. These calculations showed that the EU air quality guideline for one year average of PM10 ( $20 \mu\text{g}/\text{m}^3$ ) and the EU air quality guideline for 24 hours average of PM10 ( $50 \mu\text{g}/\text{m}^3$ ) will not be exceeded by any of the smelter's alternatives.

# Update of model calculations for a planned aluminium smelter at Hraun, Iceland

## 1. Introduction

The Norwegian Institute for Air Research (NILU) has been asked by Norsk Hydro Produksjon A.S. to carry out a comparison of recent meteorological measurements at Hraun, in Reydarfjörður, with measurements at Mjöeyri, in Eskifjörður, in the eastern part of Iceland, and to update the model calculations for a planned aluminium smelter at Hraun, using the meteorological measurements at Hraun.

The dispersion model calculations for the planned aluminium smelter have been done in order to assess the potential dispersion of sulphur dioxide and fluoride for four production alternatives: 120,000 (ALT. 1), 240,000 (ALT. 2), 360,000 (ALT. 3) and 480,000 (ALT. 4) tons of aluminium per year. Calculations have been done for these alternatives with a dry scrubber only, as well as a dry and a wet scrubber. Finally emissions from the various production alternatives have been calculated according to The Oslo and Paris Commission (PARCOM) definition of Best Available Technology (BAT) and its emission values for new prebake lines built after 1999. These guidelines are supposed to be implemented by the various European countries after the year 2005. The objective of the dispersion calculations has been to assess whether the relevant air quality guidelines are met.

Particulate matter under 10  $\mu\text{m}$  (PM10) has also been assessed for the largest production alternative in order to identify if emissions of PM10 would meet the ambient air quality guidelines for all the alternatives.

Calculations have been done for one year average for  $\text{SO}_2$  and PM10, growing season (6 months) for fluorides and 24 hours, with unfavourable meteorological dispersion conditions, for  $\text{SO}_2$ , fluorides and PM10.

The meteorological office in Reykjavik has carried out measurements of wind speed, wind direction and temperatures in the area for several years. Wind measurements have been carried out at Somastadagerdi in 1982-84 at 10 m height (Sigurdsson and Hjartarson, 1986), and more recently, between May 1998 and May 1999, at Hraun in Reydarfjörður, at 10 and 36 m heights, using two Gill UUV anemometers. Temperatures along the hillside at heights 3 m and 92 m above sea level were measured at Mjöeyri at Eskifjörður (Figure 1) between 1 November 1983 and 30 November 1984 (Sigurdsson and Hjartarson, 1986). Recent measurements of temperature were taken at the heights of 3 and 38 m between May 1998 and May 1999.

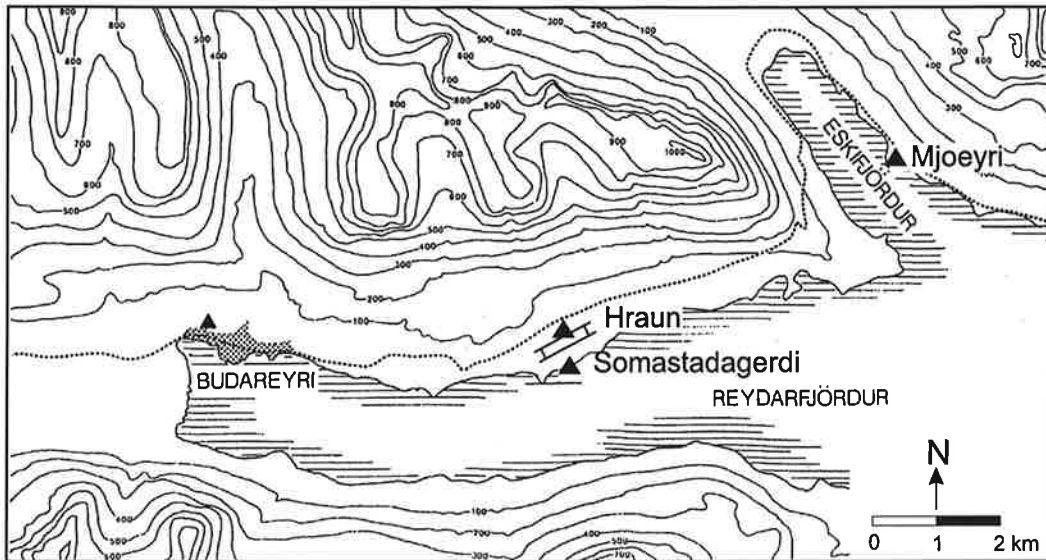


Figure 1: Location of the wind and temperature observations and the planned aluminium smelter.

The recent meteorological measurements taken at Hraun have been used to update the dispersion calculations previously done for a planned aluminium smelter at Hraun.

## 2. Proposed air quality guidelines

The Icelandic authorities have proposed air quality guidelines for sulphur dioxide and PM10, while no guidelines exist for fluorides. The proposed Icelandic, Norwegian and EU air quality guidelines are presented in *Table 1* below. The most restrictive guidelines have been used in this study.

Table 1: Air quality guidelines for SO<sub>2</sub>, fluorides and PM10 in Iceland and Norway. Unit: µg/m<sup>3</sup>.

Component	Country	Period			
		24 h	30 d	6 months	Year
Sulphur dioxide	Iceland <sup>1)</sup>	50 <sup>2)</sup>			30
Sulphur dioxide	Norway	100 – 150		40 - 60	
Sulphur dioxide veget.	Norway			25	
Sulphur dioxide	EU	125 <sup>3)</sup>			20
Fluorides, health <sup>4)</sup>	Norway	25		10	
Fluorides, veget. <sup>5)</sup>	Norway	1.0		0.3	
Fluorides, herbivores <sup>4)</sup>	Norway		0.2 - 0.4		
PM10	Iceland	130 <sup>2)</sup>			40
PM10	EU	50 <sup>2), 6)</sup>			20 <sup>6)</sup>

<sup>1)</sup> Environmental and Food Agency of Iceland (1994)

<sup>2)</sup> 98-percentile

<sup>3)</sup> Not to be exceeded more than 3 times a year

<sup>4)</sup> Guideline for total fluorides

<sup>5)</sup> Guideline for gaseous fluorides only

<sup>6)</sup> To be met 1 January 2010

### 3. Meteorological conditions

Recent measurements of wind and temperatures have been carried out by the meteorological office in Reykjavik at Hraun in Reydarfjörður, between May 1998 and May 1999. NILU has compared these recent meteorological measurements with measurements carried out in 1984 in the same area, but at different locations.

#### 3.1 Wind speed and wind direction

NILU has carried out a statistical evaluation of 10 min. averaged wind measurements at Hraun in the period from May 1998 to May 1999 and compared with wind measurements at Somastadagerdi measured from October 1982 to October 1984. The wind speed measurements used were carried out at 10 m height at both sites. The wind direction frequency distribution in twelve 30 degrees sectors and four wind speed classes for the summer, the winter, the growing season and for the year, are presented in Figure 2 for Somastadagerdi and in Figure 3 for Hraun.

The wind roses in figure 2 and figure 3 are very similar. Both measurement years/stations show a strong channelling effect along the east-west oriented valley axis (ca. 41% at Hraun and ca. 39% at Somastadagerdi). The average wind speed for one year was 4.5 m/s at Hraun and 4.1 m/s at Somastadagerdi. The predominant wind was down valley winds from west (about 24% of time at Hraun and about 20% of the time at Somastadagerdi). Onland winds (sea-breeze) from east occurred in about 17% of time at Hraun and about 19% of time at Somastadagerdi, mostly during daytime hours.

The highest averaged wind speed in one wind sector occurred during down valley winds from west-south-west in both stations. At Hraun, west winds with higher wind speed than 6 m/s occurred 11.4% of time, while at Somastadagerdi such winds only occurred in 7.6% of time.



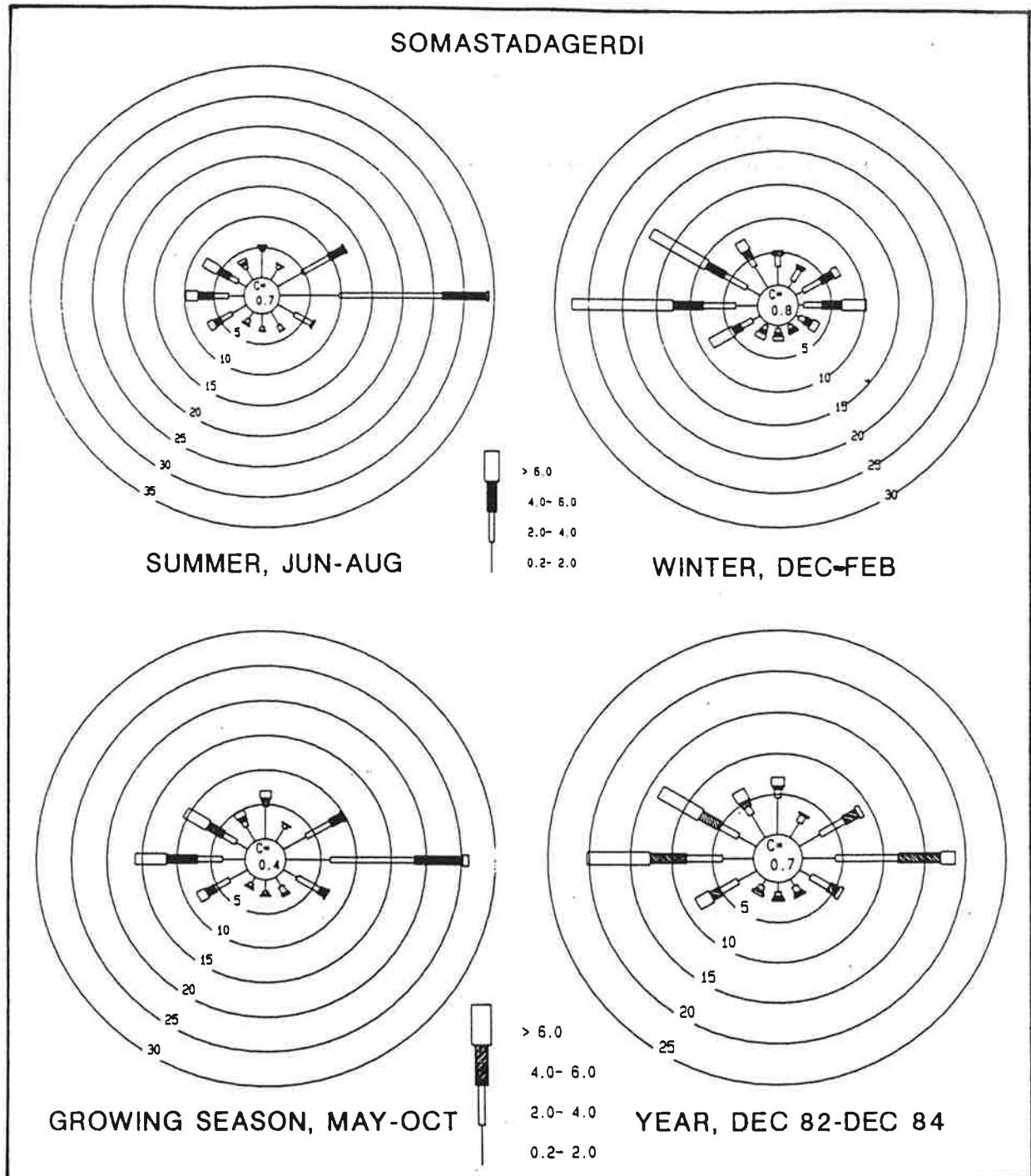
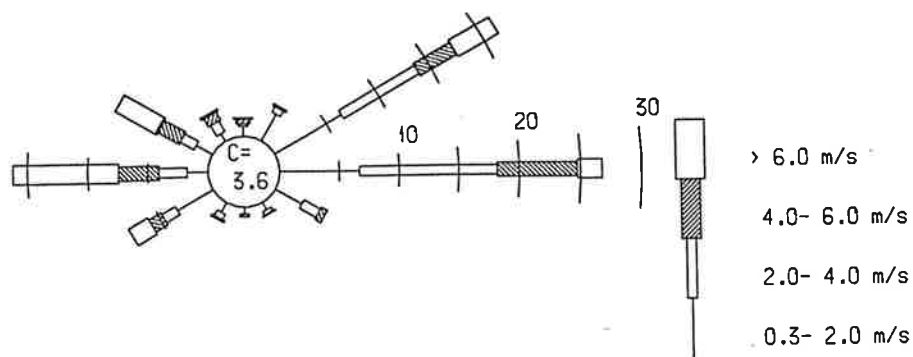
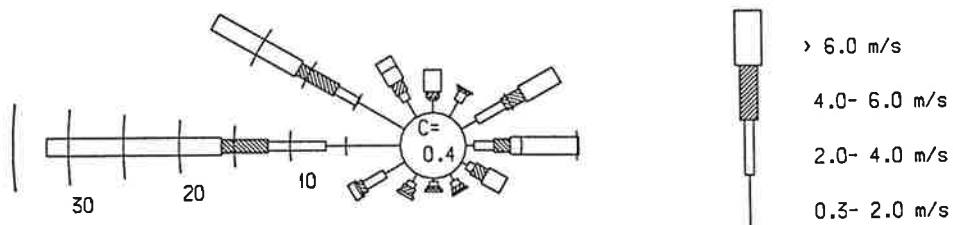


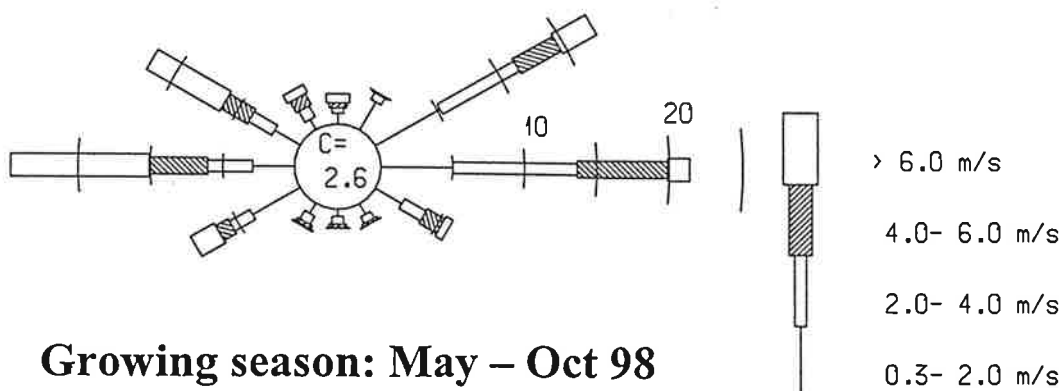
Figure 2: Average wind direction frequency distribution at Somastadagerdi for the summer, the winter, the growing season and over the year.



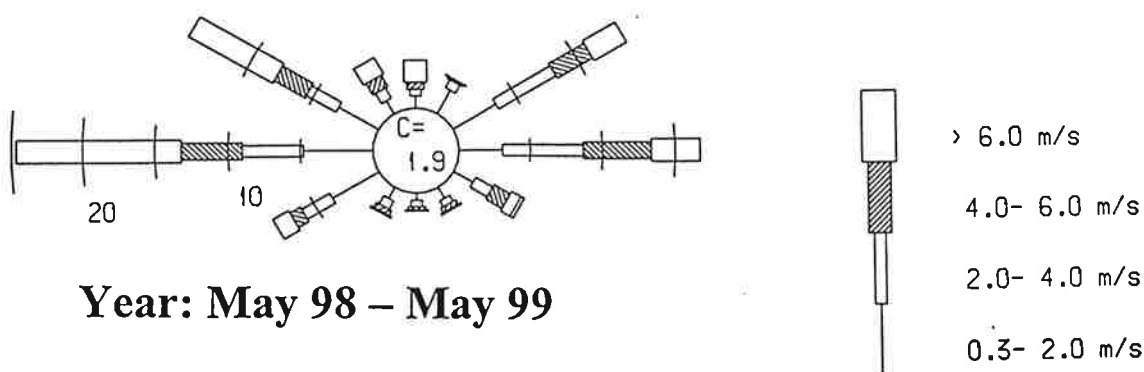
**Summer: Jun – Aug 98**



**Winter: Dec 98 – Feb 99**



**Growing season: May – Oct 98**



**Year: May 98 – May 99**

*Figure 3: Average wind direction frequency distribution at Hraun for the summer, the winter, the growing season and over the year.*

### 3.2 Stability

The stability classification is divided into four classes of stability: unstable, neutral, light-stable and stable conditions. The definition of these classes is given below.

Unstable:	$\Delta T < -0.8^\circ \text{ C}$	between 38 and 3 m
Neutral:	$-0.8^\circ \text{ C} < \Delta T < 0^\circ \text{ C}$	between 38 and 3 m
Light-stable:	$0^\circ \text{ C} < \Delta T < 0.8^\circ \text{ C}$	between 38 and 3 m
Stable:	$0.8^\circ \text{ C} < \Delta T$	between 38 and 3 m

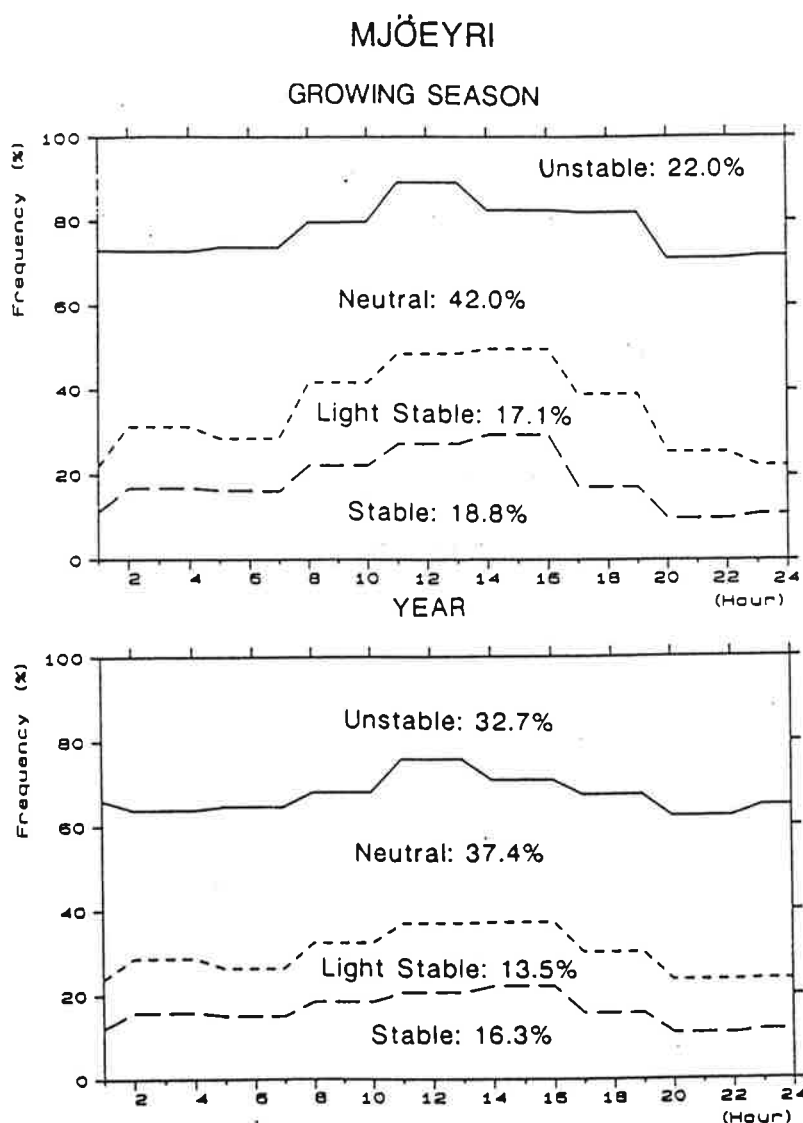
#### *Measurements at Mjöeyri in Eskifjörður*

The meteorological office in Reykjavik has carried out temperature measurements along the hillside at Mjöeyri in Eskifjörður from 1 December 1982 to 30 November 1984. The temperatures were measured at 3 m, 92 m, 260 m and 520 m above sea level (Sigurdsson and Hjartarson, 1986). The temperature measurements at 92 m started 1 November 1983. The temperature difference between 92 m and 3 m above sea level was selected to evaluate the atmospheric stability in the area, and has been used in the previous dispersion calculations.

The stability distributions for the growing season and for the year are given in Figure 4. The Figure shows an occurrence of unstable conditions of 22% during the growing season and of 32,7% during the year, with higher occurrence during night time hours compared to day time. It also shows a higher occurrence of stable conditions during day time hours compared to night time. These results do not reflect an expected occurrence of stability conditions during the day and the season.

The lowest temperature sensor was placed on the seashore, measuring temperatures strongly influenced by the sea temperature. This explains the high occurrence of unstable conditions over the year, due to heating of the lower sensor by the sea, which on the average was warmer than the air. The high occurrence of stable conditions during day time hours in the growing season (May-October) can be explained by heating of the higher sensor by the sun during day time hours and constant temperature at the sea surface, resulting in stable conditions between the two heights considered. Simultaneous observations of the temperature in the sea and in the atmosphere carried out at Torvaldsstadir in the period 1971-80 showed that the sea on average over the year was  $1^\circ \text{ C}$  warmer than the air. In the period from May to September the sea was slightly colder than the air.

The planned smelter will be built 300-500 m from the seashore. The stability measurements carried out at Mjöeyri and used in the dispersion calculations have therefore overestimated the occurrence of stable conditions during day time hours in the summer and unstable conditions during the winter period.



*Figure 4: Stability distribution of four classes of stability at Mjöeyri for the growing season and for the year.*

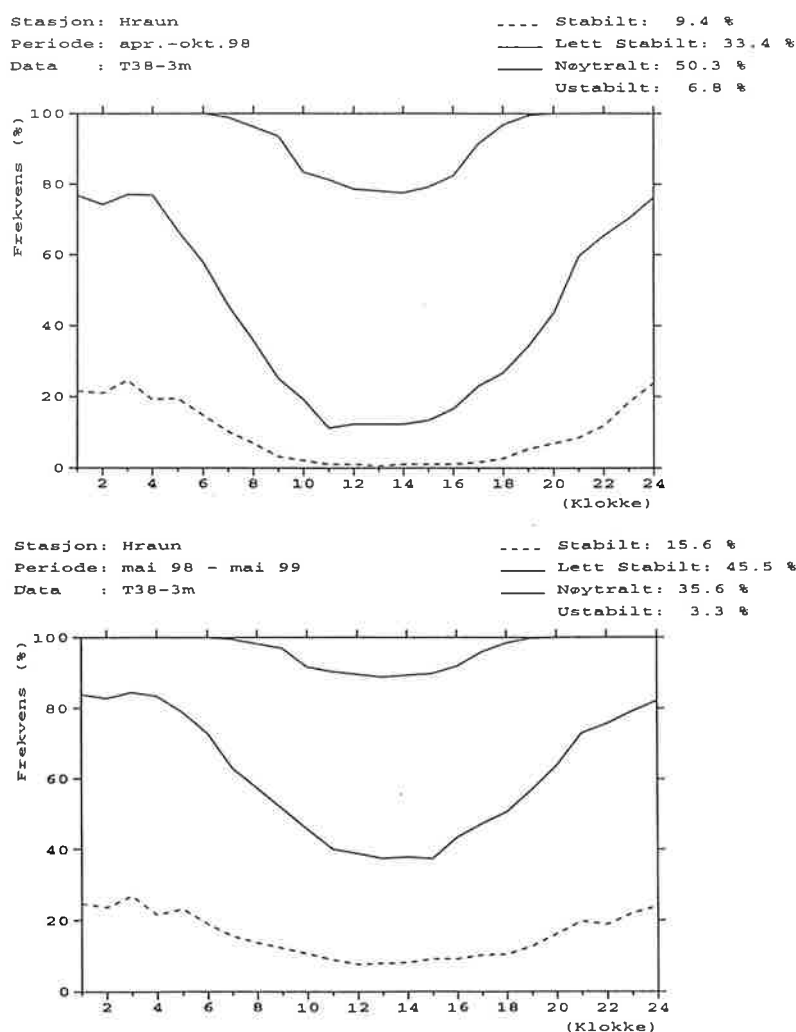
#### ***Measurements at Hraun in Reydarfjörður***

Recent measurements of temperature difference (3 and 38 m) show a common picture of stability occurrence during the day.

The stability distributions for the growing season and for the year are given in Figure 5. The Figure shows an occurrence of unstable conditions of 6.8% during the growing season and of 3.3% during the year, which only occurs during daytime, as expected. Stable conditions occurred in 9.4% of the time during the growing season and of 15.6% during the year, mostly during night-time. The occurrence of stable conditions during the day may be explained by the fact that Hraun is shaded by the mountains in the south side of the Reydarfjörður during the whole day in winter and probably some days in spring and autumn. In such cold days the stable conditions built up during the night are never broken by the

sun. The figure shows clearly that light-stable and stable conditions are predominant during night-time and that neutral and unstable conditions are predominant during the day, as expected.

The re-calibration of the temperature sensors in July 1999 show that the measurements at 3 m height were underestimating temperature by  $0.1^{\circ}\text{C}$ . This means that the occurrence of stable and light-stable conditions, previously presented in this report for Hraun, may be slightly overestimated during an unknown period of the measurements year. Correcting the temperature measured at 3 m during the whole year with  $+0.1^{\circ}\text{C}$ , the stable and light-stable conditions are reduced by 2,2% and 3,5%, respectively, while the neutral and unstable conditions are increased by 4,5% and 1,2%, respectively. Due to the uncertainty of the period when the temperature should be corrected and due to the fact that the correction will not have a visible impact on the dispersion calculation's results, we have chosen to use the data without corrections.



*Figure 5: Stability distribution of four classes of stability at Hraun for the growing season and for the year.*

### 3.3 Meteorological matrixes for dispersion calculations

The results of the model calculations will be compared with the air quality guidelines given in Table 1. The averaging period is one year for SO<sub>2</sub> and 6 months (growing season) for fluorides. The EU guideline for SO<sub>2</sub> averaged over one year has been used to compare with the SO<sub>2</sub> calculated concentrations. The calculated concentrations of gaseous and total fluorides were compared with the Norwegian guidelines for vegetation (gaseous fluorides) for the growing season and with the Norwegian guidelines for health (total fluorides) for 6 months.

The meteorological matrixes for the growing season and for the year are presented in Table 2. Simultaneous observations of wind and stability at Hraun have been used to carry out statistical evaluation of a joint frequency distribution of four wind speed classes, twelve wind sectors and four stability classes.

Table 2: Joint frequency distribution of stability, wind speed and wind direction for the growing season and for the year.

		GROWING SEASON																
		0.0- 2.0 m/s				2.0- 4.0 m/s				4.0- 6.0 m/s				over 6.0 m/s				
Wind-dir.		I	II	III	IV	I	II	III	IV	I	II	III	IV	I	II	III	IV	Rose
30	0.0	0.5	0.9	0.9	0.0	0.2	0.2	0.1	0.0	0.0	0.0	0.0	0.0	0.0	0.0	0.0	0.0	2.9
60	0.0	2.9	1.8	0.4	0.0	3.9	1.9	0.3	0.2	2.3	0.8	0.1	0.3	2.0	0.3	0.0	0.0	17.3
90	0.0	3.7	0.9	0.3	0.3	7.2	1.0	0.0	2.4	3.0	0.7	0.1	0.4	0.8	0.3	0.0	0.0	21.2
120	0.0	1.3	0.6	0.1	0.2	1.3	0.2	0.0	0.1	0.8	0.5	0.0	0.0	0.2	0.3	0.0	0.0	5.7
150	0.0	0.5	0.3	0.0	0.0	0.2	0.3	0.0	0.0	0.2	0.0	0.0	0.0	0.0	0.0	0.0	0.0	1.5
180	0.0	0.2	0.2	0.1	0.0	0.3	0.2	0.0	0.1	0.1	0.1	0.0	0.0	0.0	0.0	0.0	0.0	1.3
210	0.0	0.4	0.3	0.1	0.2	0.3	0.1	0.0	0.1	0.1	0.1	0.0	0.0	0.1	0.0	0.0	0.0	1.8
240	0.0	1.3	1.7	0.8	0.1	0.8	0.6	0.1	0.2	0.5	0.3	0.0	0.3	0.5	1.1	0.1	0.1	8.5
270	0.0	0.5	1.2	1.1	0.1	0.9	1.4	0.7	0.3	1.3	1.9	0.5	0.8	3.6	5.3	0.5	0.5	20.1
300	0.0	0.3	0.6	1.1	0.1	0.8	0.8	0.2	0.1	1.0	0.8	0.2	0.3	2.8	2.4	0.3	0.3	11.7
330	0.0	0.1	0.3	0.4	0.1	0.5	0.2	0.1	0.0	0.5	0.3	0.0	0.0	0.3	0.2	0.1	0.1	3.1
360	0.0	0.1	0.3	0.3	0.0	0.2	0.1	0.0	0.0	0.2	0.1	0.0	0.0	0.3	0.3	0.0	0.0	2.1
Calm	0.0	0.9	1.3	0.4														2.7
Total	0.0	12.8	10.5	6.1	1.1	16.7	7.1	1.4	3.6	10.0	5.6	0.9	2.1	10.7	10.2	1.0	1.0	100.0
Occurrence		29.5 %				26.4 %				20.0 %				24.0 %				
Wind speed		1.1 m/s				3.0 m/s				5.0 m/s				8.9 m/s				
Occurrence		Class I 6.8 %				Class II 50.3 %				Class III 33.4 %				Class IV 9.4 %				100.0 %

		YEAR																
		0.0- 2.0 m/s				2.0- 4.0 m/s				4.0- 6.0 m/s				over 6.0 m/s				
Wind-dir.		I	II	III	IV	I	II	III	IV	I	II	III	IV	I	II	III	IV	Rose
30	0.0	0.3	0.8	0.8	0.0	0.1	0.3	0.2	0.0	0.0	0.1	0.0	0.0	0.0	0.0	0.0	0.0	2.7
60	0.0	1.5	1.4	0.6	0.0	2.2	1.8	0.6	0.1	1.4	1.2	0.2	0.2	1.2	1.2	1.1	0.0	13.6
90	0.0	2.0	0.8	0.3	0.2	4.1	1.2	0.2	1.2	2.3	1.1	0.1	0.2	1.4	1.7	0.1	0.1	16.7
120	0.0	0.8	0.5	0.2	0.1	0.9	0.4	0.0	0.1	0.6	0.6	0.0	0.0	0.3	0.7	0.0	0.0	5.2
150	0.0	0.4	0.3	0.1	0.0	0.2	0.3	0.0	0.0	0.2	0.2	0.0	0.0	0.0	0.1	0.0	0.0	1.8
180	0.0	0.2	0.2	0.1	0.0	0.2	0.2	0.0	0.0	0.1	0.1	0.0	0.0	0.0	0.0	0.1	0.0	1.3
210	0.0	0.3	0.3	0.2	0.1	0.3	0.2	0.1	0.1	0.0	0.3	0.0	0.0	0.0	0.1	0.0	0.0	2.1
240	0.0	1.0	1.6	1.2	0.1	0.9	0.9	0.4	0.1	0.3	0.4	0.0	0.1	0.3	0.8	0.1	0.1	8.1
270	0.0	0.6	1.8	2.4	0.0	0.8	2.3	1.1	0.1	1.1	2.2	0.8	0.3	2.8	7.4	0.9	0.9	24.6
300	0.0	0.3	1.0	1.8	0.1	0.6	1.1	0.6	0.1	0.9	1.2	0.4	0.1	2.6	3.5	0.4	0.4	14.6
330	0.0	0.1	0.5	0.5	0.0	0.3	0.4	0.1	0.0	0.4	0.5	0.1	0.0	0.3	0.9	0.0	0.0	4.1
360	0.0	0.1	0.3	0.4	0.0	0.2	0.2	0.0	0.0	0.2	0.3	0.0	0.0	0.3	1.2	0.0	0.0	3.4
Calm	0.0	0.5	1.0	0.4														1.9
Total	0.0	8.1	10.6	9.0	0.6	10.7	9.2	3.3	1.7	7.5	8.1	1.6	1.0	9.3	17.6	1.6	1.6	100.0
Occurrence		27.6 %				23.8 %				19.0 %				29.5 %				
Wind speed		1.1 m/s				3.0 m/s				5.0 m/s				9.1 m/s				
Occurrence		Class I 3.3 %				Class II 35.6 %				Class III 45.5 %				Class IV 15.6 %				100.0 %

#### 4. Emission data

The emission data for the four production alternatives for the planned smelter is provided by Norsk Hydro Produksjon A.S. (Tables 3 to 10). The annual production of aluminium is assumed to be 120,000 t/y for ALT. 1, 240,000 t/y for ALT. 2 and 360,000 t/y for ALT. 3 and 480,000 t/y for ALT. 4.

Table 3 presents the emission conditions for all alternatives. The gas temperature used in the dispersion calculations (10° C) is lower than the real gas temperature (about 60° C). This leads to conservative concentration calculations for the alternatives where the use of a dry scrubber only is proposed, especially for SO<sub>2</sub>, of which 90% is emitted by stacks.

*Table 3: Emission conditions for all alternatives.*

	Stacks	Pot-rooms
Height (m)	55	22
Stack diameter (m)	4.5	
Pot-room length (m)		1150
Gas temp. (° C)	10*	30
Gas velocity (m/s)	17.5	1-2
Gas volume (m <sup>3</sup> /h)	1 000,000	21 000,000

\* This gas temperature is lower than the expected one for the alternatives using dry scrubber only, leading to conservative estimates of the concentrations calculated in this report.

The emission limits for airborne fluorides, sulphur dioxide and dust / PM10 for a recently built aluminium smelter in Iceland is as shown in Table 4.

*Table 4: Emission limits for new aluminium smelters in Iceland.*

Emission	Annual average kg/t Al	Short term average kg/t Al
Total Fluorides	0.6	0.8
Sulphur dioxide	21.0	28.0
PM10	1.0	1.3

The Environmental and Food Agency of Iceland, responsible for the operating licence for industrial facilities, will decide on the emission requirements for each plant individually, taking into account location and site specific aspects.

The purpose of the calculations made in this report is to show the possible ground level concentration for gaseous fluorides, sulphur dioxide and PM10 (µg/m<sup>3</sup>) for

emissions in accordance with the current requirements compared to likely emissions under normal operational conditions with and without wet scrubber. Table 5 shows the emission values, which the proposed aluminium smelter should be able to meet under normal working conditions, used for the calculations of total and gaseous fluorides averaged over 6 months (growing season). Each alternative of production of aluminium has three sub-alternatives for emission factors of fluorides (kg/tonne Al): one with a dry scrubber, one with both a dry and a wet scrubber and one with an emission factor defined by PARCOM / BAT.

The emissions for the ALT. 3 (360,000 t/y) and ALT. 4 (480,000 t/y) without a wet scrubber are presented in Tables 5, 6 and 9, but are not taken into account in the dispersion calculations, since they are not actual alternatives. For these two production volumes, the smelter would be equipped with a wet scrubber.



*Table 5: Yearly average emission of fluorides for the four production alternatives.*

Smelter Alternatives	Annual Al Production (t Al/y)	Source of emission factor	Wet-scrubber	Fluoride emissions			
				Total		Gaseous	
				(kg/t Al)	(t /y)	(kg/t Al)	(t /y)
ALT. 1a	120,000	PARCOM / BAT	-	0.6	72	0.36	43.2
ALT. 1b	120,000	HYDRO	With	0.25	30	0.15	18.0
ALT. 1b	120,000	HYDRO	Without	0.35	42	0.21	25.2
ALT. 2a	240,000	PARCOM / BAT	-	0.6	144	0.36	86.4
ALT. 2b	240,000	HYDRO	With	0.25	60	0.15	36.0
ALT. 2b	240,000	HYDRO	Without	0.35	84	0.21	50.4
ALT. 3a	360,000	PARCOM / BAT	-	0.6	216	0.36	129.6
ALT. 3b	360,000	HYDRO	With	0.25	90	0.15	54.0
ALT. 3b	360,000	HYDRO	Without	0.35	126	0.21	75.6
ALT. 4a	480,000	PARCOM / BAT	-	0.6	288	0.36	172.8
ALT. 4b	480,000	HYDRO	With	0.25	120	0.15	72.0
ALT. 4b	480,000	HYDRO	Without	0.35	168	0.21	100.8

Smelter Alternatives	Annual Al Production (t Al/y)	Source of emission factor	wet-scrubber	1 stack emission (g/s)	1 pot-room emission (g/s)	Number of	
						Stacks	Pot-rooms
ALT. 1a	120,000	PARCOM / BAT	-	0.150	2.70	1	0.5*
ALT. 1b	120,000	HYDRO	With	0.063	1.13	1	0.5*
ALT. 1b	120,000	HYDRO	Without	0.088	1.58	1	0.5*
ALT. 2a	240,000	PARCOM / BAT	-	0.150	2.70	2	1
ALT. 2b	240,000	HYDRO	With	0.063	1.13	2	1
ALT. 2b	240,000	HYDRO	Without	0.088	1.58	2	1
ALT. 3a	360,000	PARCOM / BAT	-	0.150	2.70	3	1.5*
ALT. 3b	360,000	HYDRO	With	0.063	1.13	3	1.5*
ALT. 3b	360,000	HYDRO	Without	0.088	1.58	3	1.5*
ALT. 4a	480,000	PARCOM / BAT	-	0.150	2.70	4	2
ALT. 4b	480,000	HYDRO	With	0.063	1.13	4	2
ALT. 4b	480,000	HYDRO	Without	0.088	1.58	4	2

\* 0,5 pot-room is a pot-room with half of the length and gas volume of one pot-room defined in Table 3.

Table 6 presents the emission values used for the calculations of SO<sub>2</sub> averaged over one year. Each alternative of production of aluminium has two sub-alternatives for emission factors of SO<sub>2</sub> (kg SO<sub>2</sub> /tonne Al), one with a dry scrubber, one with both a dry and a wet scrubber.

*Table 6: Yearly average emission of SO<sub>2</sub> for the four production alternatives with or without wet scrubber.*

Smelter Alternatives	Annual Al Production (t Al/y)	Wet scrubber	SO <sub>2</sub> emission		
			(kg/t Al)	(t /y)	% of national emissions in 1995*
ALT. 1b	120,000	With	6.6	792	3.3
		Without	21.0	2520	10.5
ALT. 2b	240,000	With	6.6	1584	6.6
		Without	21.0	5040	21.0
ALT. 3b	360,000	With	6.6	2376	9.9
		Without	21.0	7560	31.5
ALT. 4b	480,000	With	6.6	3168	13.2
		Without	21.0	10080	42

\* (Acid News, 1997)

Smelter Alternatives	Annual Al production (t Al/y)	SO <sub>2</sub> -scrubber	1 stack emission (g/s)	1 pot-room emission (g/s)	Number of	
					Stacks	Pot-rooms
ALT. 1b	120,000	With	24.75	5.5	1	0.5*
		Without	78.75	17.5	1	0.5*
ALT. 2b	240,000	With	24.75	5.5	2	1
		Without	78.75	17.5	2	1
ALT. 3b	360,000	With	24.75	5.5	3	1.5*
		Without	78.75	17.5	3	1.5*
ALT. 4b	480,000	With	24.75	5.5	4	2
		Without	78.75	17.5	4	2

\* 0,5 pot-room is a pot-room with half of the length and gas volume of one pot-room defined in Table 3.

Table 7 presents the emission values of PM10 averaged over one year. The emission factors for PM10 correspond to 10% of the emission factors for total dust provided by Norsk Hydro, since, following Norsk Hydro, only 10% of the dust emissions are under 10 µm (corresponding to PM10). Each alternative of production of aluminium has three sub-alternatives for emission factors of PM10

(kg/tonne Al): one with a dry scrubber, one with both a dry and a wet scrubber and one with an emission factor defined by PARCOM / BAT.

Table 7: Yearly average emission of PM10 for the four production alternatives.

Smelter Alternatives	Annual Al Production (t Al/y)	Source of emission factor	Wet-scrubber	PM10 emissions	
				(kg/t Al)	(t /y)
ALT. 1a	120,000	PARCOM / BAT	-	0.100	12
ALT. 1b	120,000	HYDRO	With	0.075	9
ALT. 1b	120,000	HYDRO	Without	0.061	7
ALT. 2a	240,000	PARCOM / BAT	-	0.100	24
ALT. 2b	240,000	HYDRO	With	0.075	18
ALT. 2b	240,000	HYDRO	Without	0.061	15
ALT. 3a	360,000	PARCOM / BAT	-	0.100	36
ALT. 3b	360,000	HYDRO	With	0.075	27
ALT. 3b	360,000	HYDRO	Without	0.061	22
ALT. 4a	480,000	PARCOM / BAT	-	0.100	48
ALT. 4b	480,000	HYDRO	With	0.075	36
ALT. 4b	480,000	HYDRO	Without	0.061	29

Smelter Alternatives	Annual Al Production (t Al/y)	Source of emission factor	wet-scrubber	1 stack emission (g/s)	1 pot-room emission (g/s)	Number of	
						Stacks	Pot-rooms
ALT. 1a	120,000	PARCOM / BAT	-	0.042	0.750	1	0.5*
ALT. 1b	120,000	HYDRO	With	0.031	0.563	1	0.5*
ALT. 1b	120,000	HYDRO	Without	0.025	0.458	1	0.5*
ALT. 2a	240,000	PARCOM / BAT	-	0.042	0.750	2	1
ALT. 2b	240,000	HYDRO	With	0.031	0.563	2	1
ALT. 2b	240,000	HYDRO	Without	0.025	0.458	2	1
ALT. 3a	360,000	PARCOM / BAT	-	0.042	0.750	3	1.5*
ALT. 3b	360,000	HYDRO	With	0.031	0.563	3	1.5*
ALT. 3b	360,000	HYDRO	Without	0.025	0.458	3	1.5*
ALT. 4a	480,000	PARCOM / BAT	-	0.042	0.750	4	2
ALT. 4b	480,000	HYDRO	With	0.031	0.563	4	2
ALT. 4b	480,000	HYDRO	Without	0.025	0.458	4	2

\* 0,5 pot-room is a pot-room with half of the length and gas volume of one pot-room defined in Table 3.

Table 8, 9 and 10 present the emission values of fluorides, SO<sub>2</sub> and PM10, respectively, for 24 hours average.

*Table 8: Emission data of fluorides on a day with high emissions for the four production alternatives and on a day with normal emissions for 120,000 t Al/y (ALT.1b) without wet scrubber. All for a day with poor dispersion conditions.*

Smelter Alternatives	Annual Al production (t Al/y)	Type of emissions	Fluoride emissions			
			Total		Gaseous	
			(kg/t Al)	(t /y)	(kg/t Al)	(t /y)
ALT. 1	120,000	High	0.80	96	0.48	58
ALT. 2	240,000	High	0.65	156	0.39	94
ALT. 3	360,000	High	0.53	191	0.318	114
ALT. 4	480,000	High	0.475	228	0.285	137
ALT. 1b	120,000	Normal	0.35	228	0.285	137

*Table 9: Emission data of SO<sub>2</sub> on a day with normal emissions with or without wet scrubber (ALT. #b) and on a day with high emissions (ALT. #a), for the four production alternatives. All for a day with stationary winds from east.*

Smelter Alternatives	Annual Al Production (t Al/y)	Type of emissions	Wet scrubber	SO <sub>2</sub> emission	
				(kg/t Al)	(t /y)
ALT. 1a	120,000	High	-	28.0	3360
ALT. 1b	120,000	Normal	With	6.6	792
		Normal	Without	21.0	2520
ALT. 2a	240,000	High	-	28.0	6720
ALT. 2b	240,000	Normal	With	6.6	1584
		Normal	Without	21.0	5040
ALT. 3a	360,000	High	-	28.0	10080
ALT. 3b	360,000	Normal	With	6.6	2376
		Normal	Without	21.0	7560
ALT. 4a	480,000	High	-	28.0	13440
ALT. 4b	480,000	Normal	With	6.6	3168
		Normal	Without	21.0	10080

*Table 10: Emission data of PM10 on a day with high emissions for the four production alternatives and with stationary winds from east.*

Smelter Alternatives	Annual Al production (t Al/y)	Type of emissions	PM10 emissions	
			(kg/t Al)	(t /y)
ALT. 1	120,000	High	0.13	16
ALT. 2	240,000	High	0.13	31
ALT. 3	360,000	High	0.13	47
ALT. 4	480,000	High	0.13	62

## 5. Model calculations of long term average concentrations

NILU's dispersion model, CONDEP, was used to calculate long term average concentrations of SO<sub>2</sub> (one year) and of fluorides (growing season). The program CONDEP calculates long term average concentrations in a given grid for twelve 30° sectors (Bøhler, 1987). The input consists of source and emission data and a joint frequency matrix of meteorological variables. The program takes into account effects of stack downwash, building turbulence, wind profiles, deposition, topography and penetration through an elevated stable layer. The CONDEP model, as most Gaussian plume models, is a conservative model, i.e. it has a higher probability of overestimating concentrations than of underestimating them. The emission data, given in Tables 3, 5 and 6 and the meteorological matrix, given in Table 2, have been used as input to the long-term average dispersion calculations.

### 5.1 Sulphur dioxide

The long term average calculations of SO<sub>2</sub> concentrations have been carried out for one year of available meteorological data and compared with the EU guideline for one year. The results of the calculations are given in Figure 6, 8, 10 and 11 for ALT. 1b, 2b, 3b and 4b with wet scrubber, respectively, and in Figure 7 and 9 for ALT. 1b and 2b without wet scrubber, respectively.

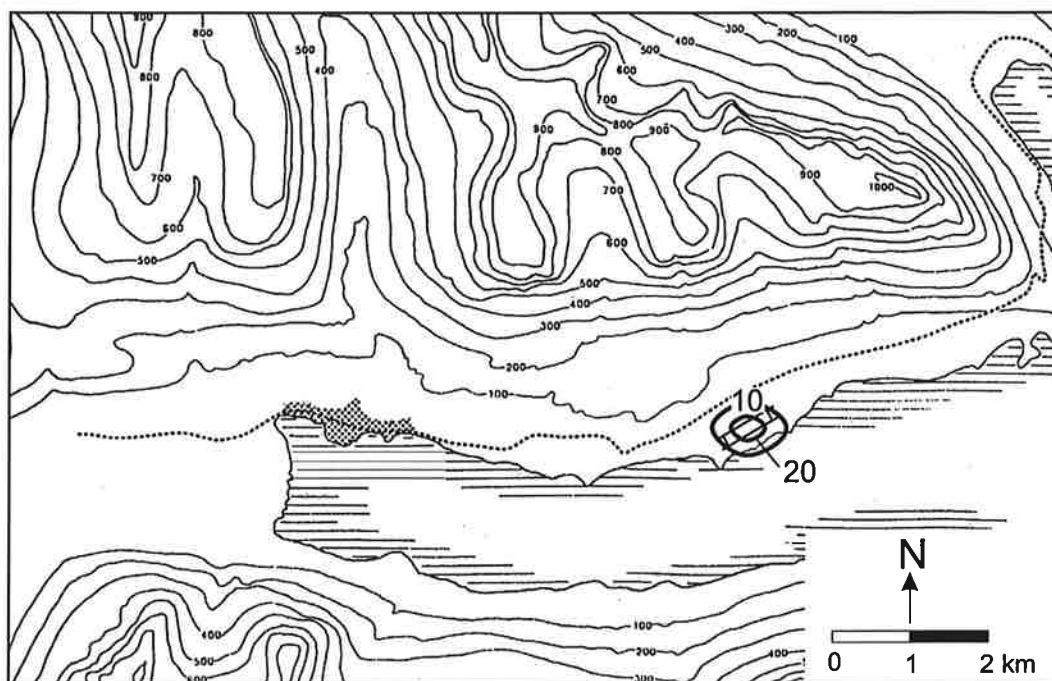


Figure 6: Annual average  $\text{SO}_2$  concentrations ( $\mu\text{g}/\text{m}^3$ ) due to emissions from ALT. 1b (120,000 t Al/y) with wet scrubber.

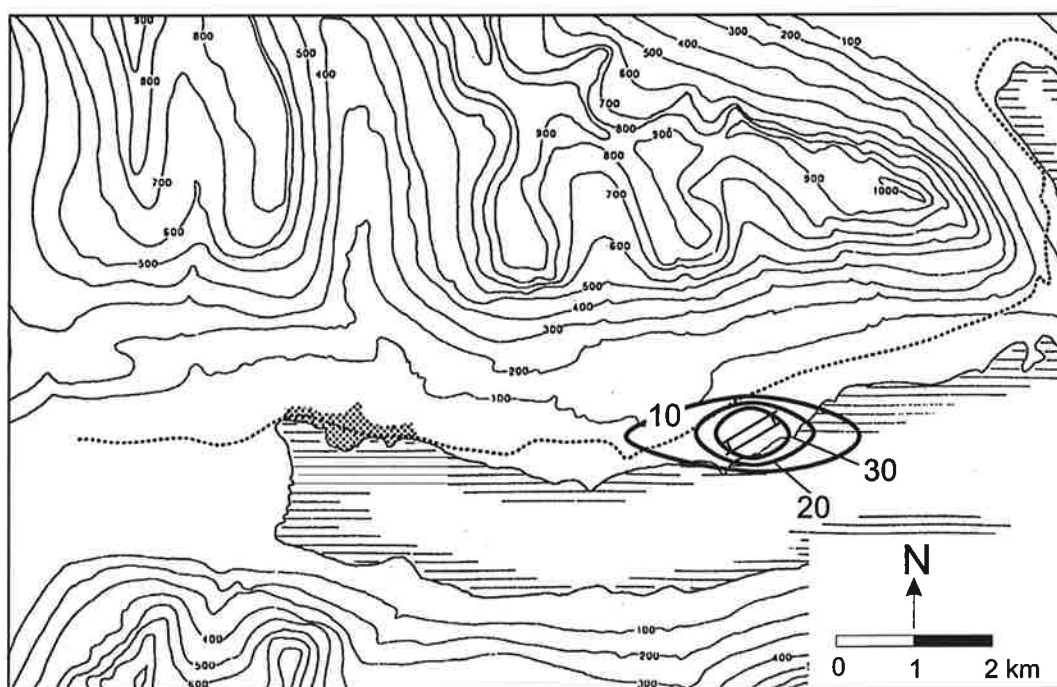


Figure 7: Annual average  $\text{SO}_2$  concentrations ( $\mu\text{g}/\text{m}^3$ ) due to emissions from ALT. 1b (120,000 t Al/y) without wet scrubber.

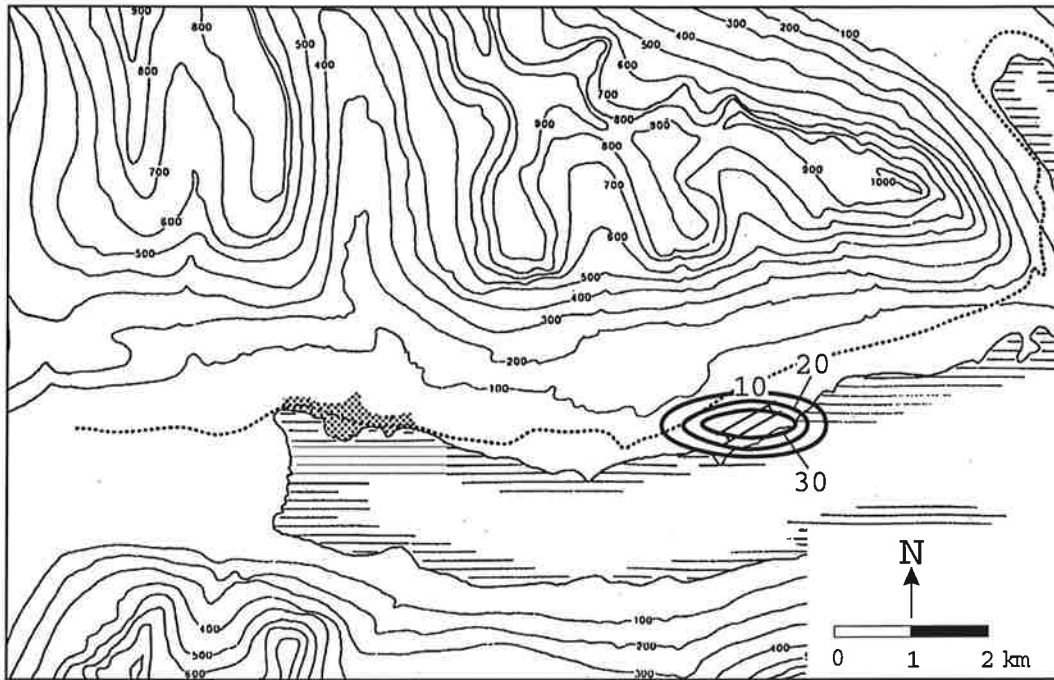


Figure 8: Annual average SO<sub>2</sub> concentrations (µg/m<sup>3</sup>) due to emissions from ALT. 2b (240,000 t Al/y) with wet scrubber.

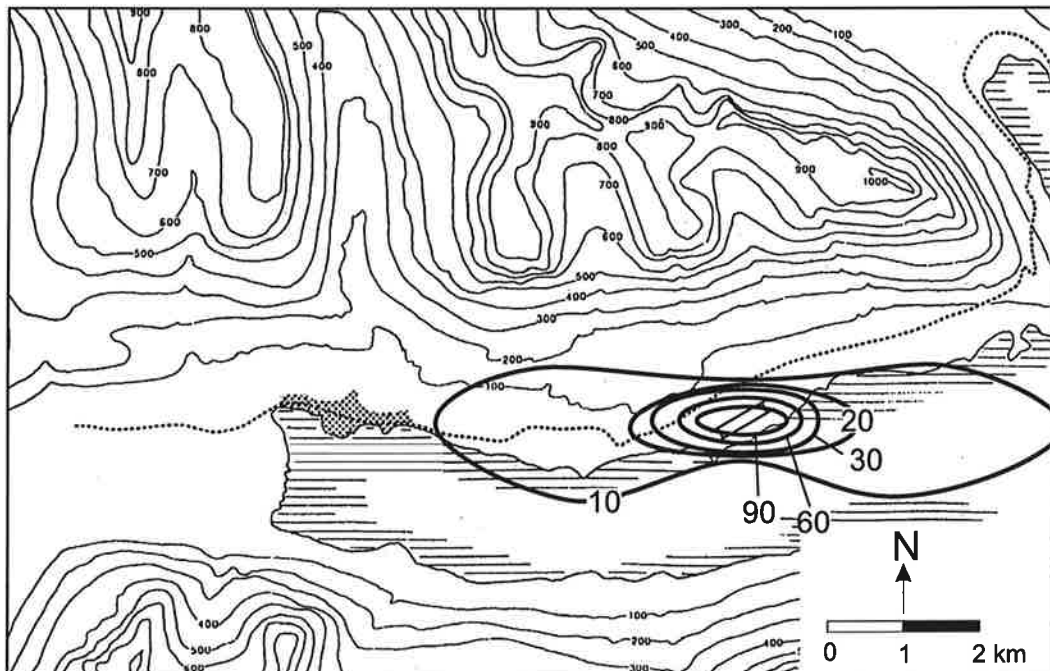


Figure 9: Annual average SO<sub>2</sub> concentrations (µg/m<sup>3</sup>) due to emissions from ALT. 2b (240,000 t Al/y) without wet scrubber.

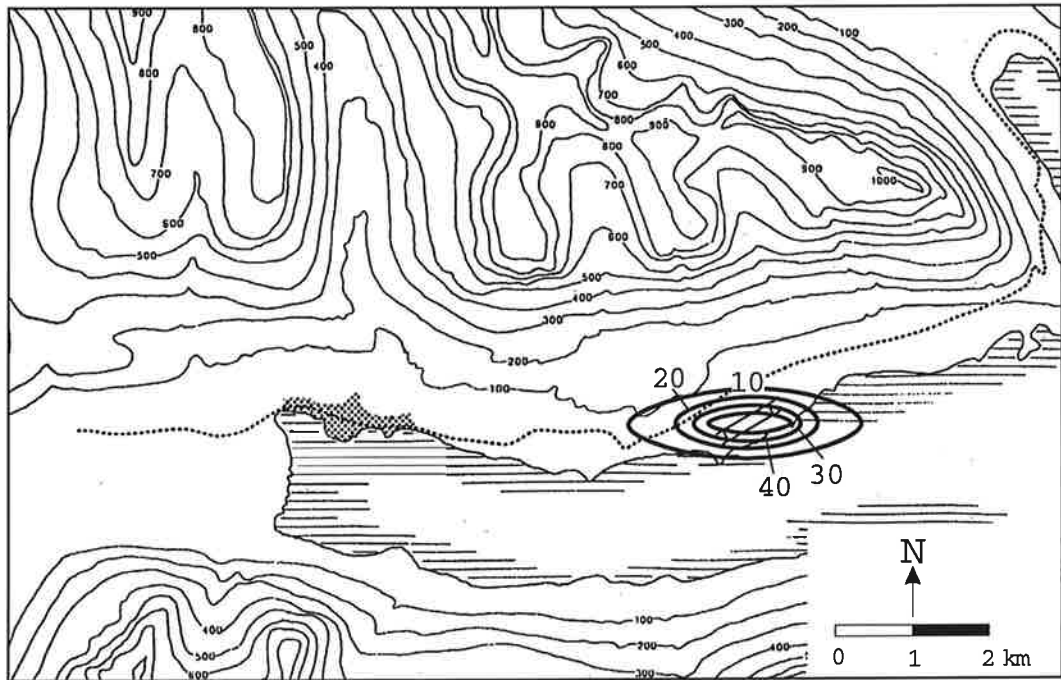


Figure 10: Annual average SO<sub>2</sub> concentrations (µg/m<sup>3</sup>) due to emissions from ALT. 3b (360,000 t Al/y) with wet scrubber.

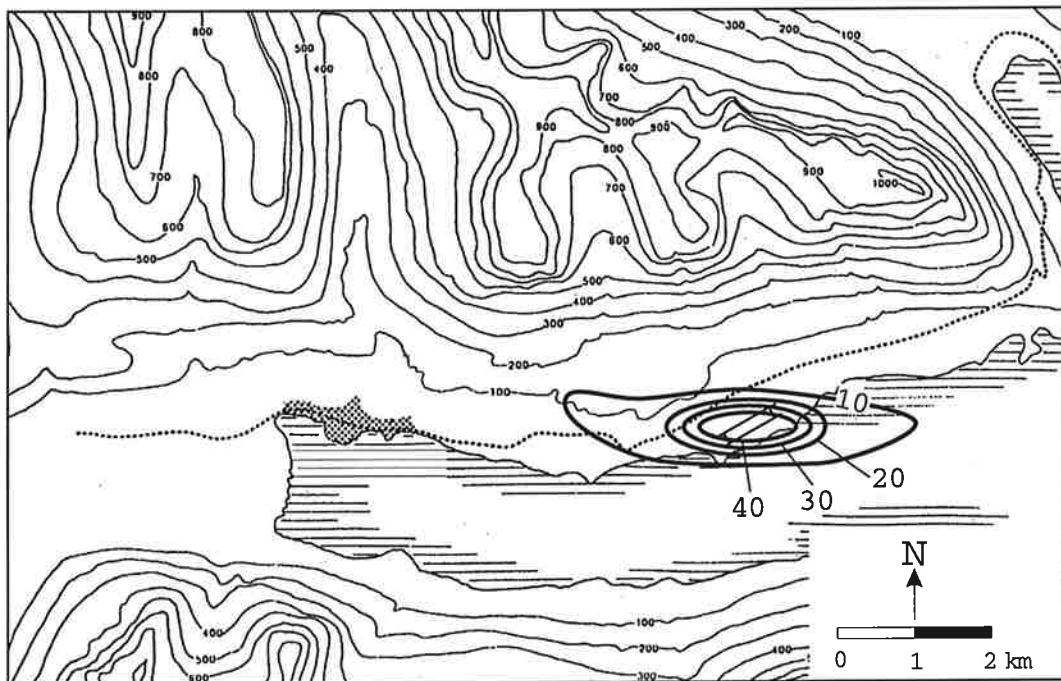


Figure 11 Annual average SO<sub>2</sub> concentrations (µg/m<sup>3</sup>) due to emissions from ALT. 4b (480,000 t Al/y) with wet scrubber.



The annual average dispersion calculations reflect the channelling of the wind along the valley axis. The area of higher impact occurred close to the smelter due to the low sources (pot-rooms) and the building influence on the emissions. The EU air quality guideline for one year average of sulphur dioxide ( $20 \mu\text{g}/\text{m}^3$ ) will not be exceeded outside the smelter industrial area for ALT. 1b, ALT. 2b and ALT. 3b with wet scrubber and for ALT. 1b without wet scrubber. ALT. 4b with wet scrubber and ALT. 2b without wet scrubber may exceed the EU guideline up to 0.5 km and 1.0 km west and 0.5 km and 0.9 km east from the smelter, respectively.

## 5.2 Gaseous fluorides

The Norwegian air quality guidelines for vegetation and human health, for 6 month average concentration, have been used in this study (Table 1). The dispersion calculations were carried out for the growing season (from May to October) to be compared to the Norwegian guideline of total fluorides (human health) and gaseous fluorides (vegetation). In this report it is assumed that 60% of the total fluorides are in the gas phase.

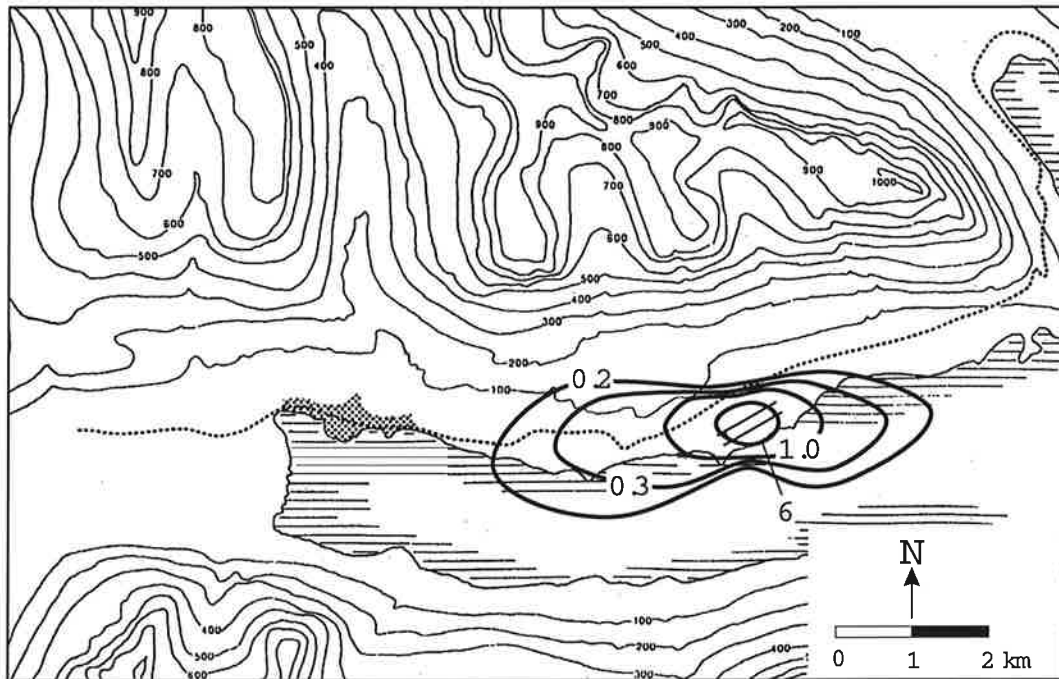
The results of the model calculations of gaseous fluorides for the growing season are given in Fig. 12, 15, 18 and 20 for ALT. 1a, ALT. 2a, ALT. 3a and ALT. 4a, respectively. They reflect the smelter operation at the PARCOM's guidelines for new aluminium smelters. Fig. 13, 16, 19 and 21 show the model results for ALT. 1b, ALT. 2b, ALT. 3b and ALT. 4b with wet scrubber, respectively, and Fig. 14 and 17 show the results for ALT. 1b and ALT. 2b without wet scrubber, respectively. These alternatives reflect the expected design values for the new smelter. The real operating values could be lower than these, according to Norsk Hydro.

The Norwegian air quality guideline for human health, for 6 month average of total fluorides is  $10 \mu\text{g}/\text{m}^3$ . This corresponds to  $6 \mu\text{g}/\text{m}^3$  of gaseous fluorides, assuming 60% of fluorides in the gas phase. Only gaseous fluorides are presented in the figures.

The figures show that the Norwegian air quality guideline for human health ( $10 \mu\text{g}/\text{m}^3$ , corresponding to  $6 \mu\text{g}/\text{m}^3$  in the figures) was exceeded up to 0.4 km, 0.5 km and 0.5 km west and 0.3 km, 0.4 km and 0.4 km east from the smelter buildings, for ALT. 2a, ALT. 3a and ALT. 4a respectively.

The dispersion calculations for gaseous fluorides in the growing season show a concentration distribution along the east-west oriented valley axis, due to high occurrence of onland winds (from west and west-north-west) and inland winds (east) during this season. The uptake of fluorides in vegetation is very complex and dependent on different parameters such as precipitation, duration of daylight, relative humidity, insulation, temperature and the type of vegetation. Taking into account the above mentioned uncertainties, the emission of fluorides might lead to exceeding of the Norwegian air quality guideline for vegetation out to about:

- 2 km, 3.2 km, 4.5 km and 9.5 km west of the smelter and up to about 1.3 km, 2.5 km, 3.5 km and 4.5 km east of the smelter for ALT. 1a, ALT. 2a, ALT. 3a and ALT. 4a, respectively;
- 0.8 km, 1.5 km, 2.0 km and 2.7 km west of the smelter and up to about 0.5 km, 1.2 km, 1.5 km and 2.1 km east of the smelter for ALT. 1b, ALT. 2b, ALT. 3b and ALT. 4b with wet scrubber, respectively;
- 1 km and 2.1 km west of the smelter and up to about 0.8 km and 1.5 km east of the smelter for ALT. 1b and ALT. 2b without wet scrubber, respectively.



*Figure 12: Long term average ground level concentrations of gaseous fluorides ( $\mu\text{g}/\text{m}^3$ ) for the growing season due to emission from ALT. 1a (120,000 t Al/y using PARCOM) for the aluminium smelter.*

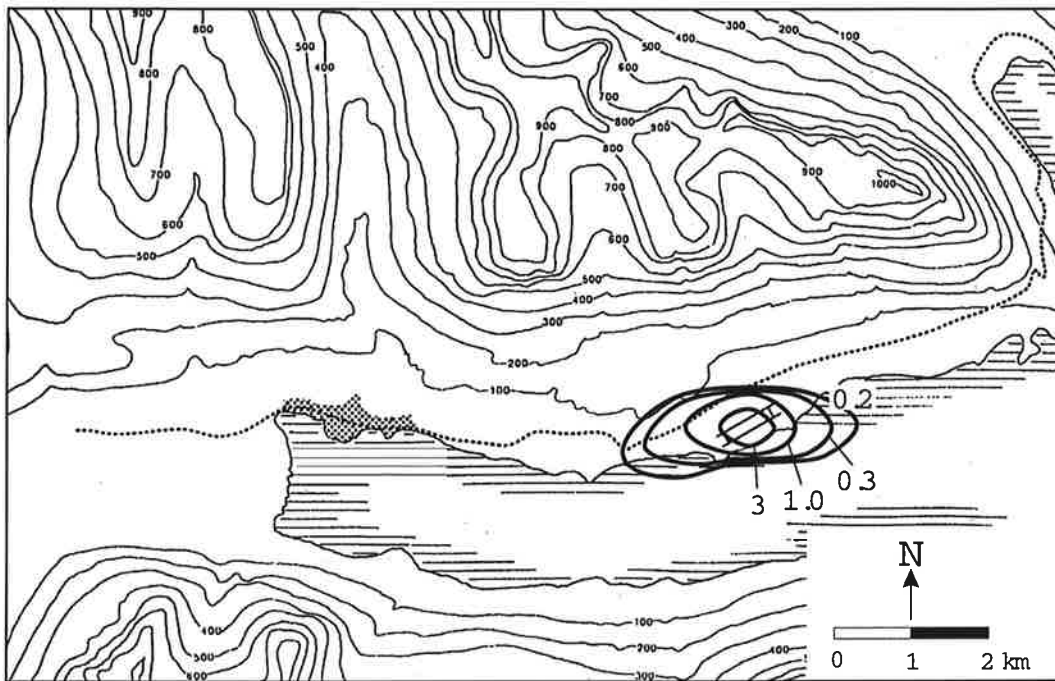


Figure 13: Long term average ground level concentrations of gaseous fluorides ( $\mu\text{g}/\text{m}^3$ ) for the growing season due to emission from ALT. 1b (120,000 t Al/y) with wet scrubber for the aluminium smelter.

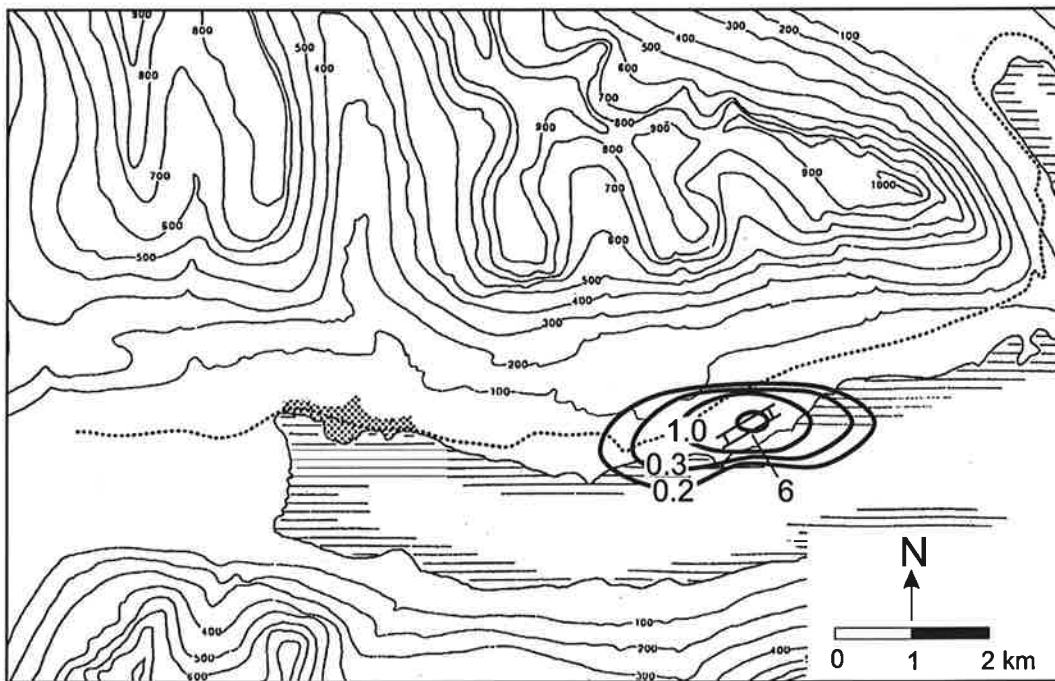


Figure 14: Long term average ground level concentrations of gaseous fluorides ( $\mu\text{g}/\text{m}^3$ ) for the growing season due to emission from ALT. 1b (120,000 t Al/y) without wet scrubber for the aluminium smelter.

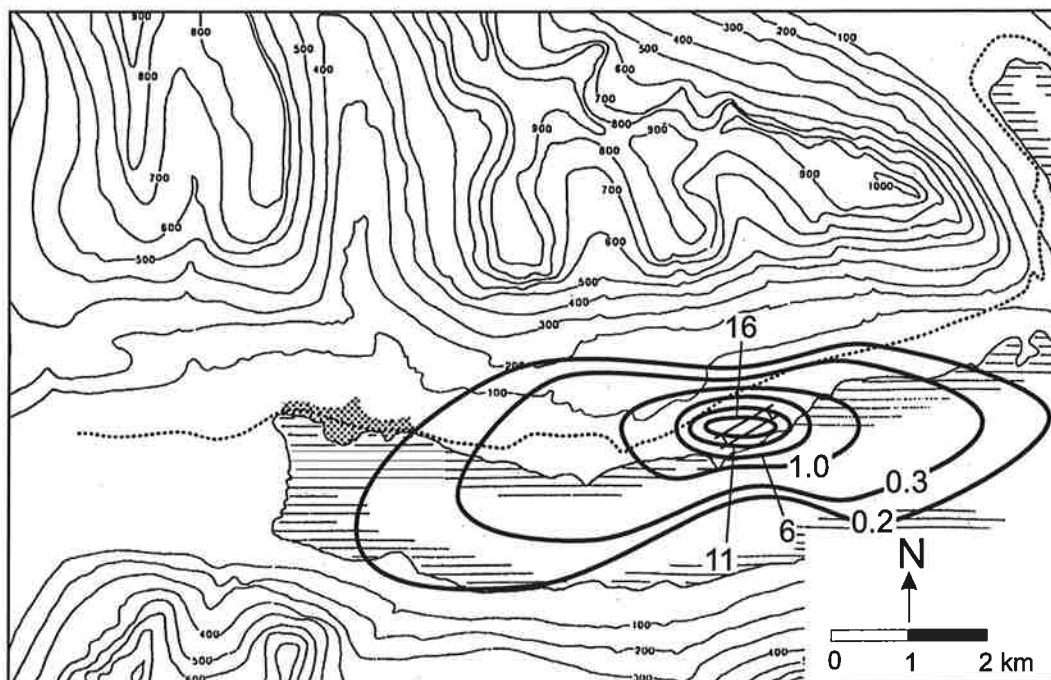


Figure 15: Long term average ground level concentrations of gaseous fluorides ( $\mu\text{g}/\text{m}^3$ ) for the growing season due to emission from ALT. 2a (240,000 t Al/y using PARCOM) for the aluminium smelter.

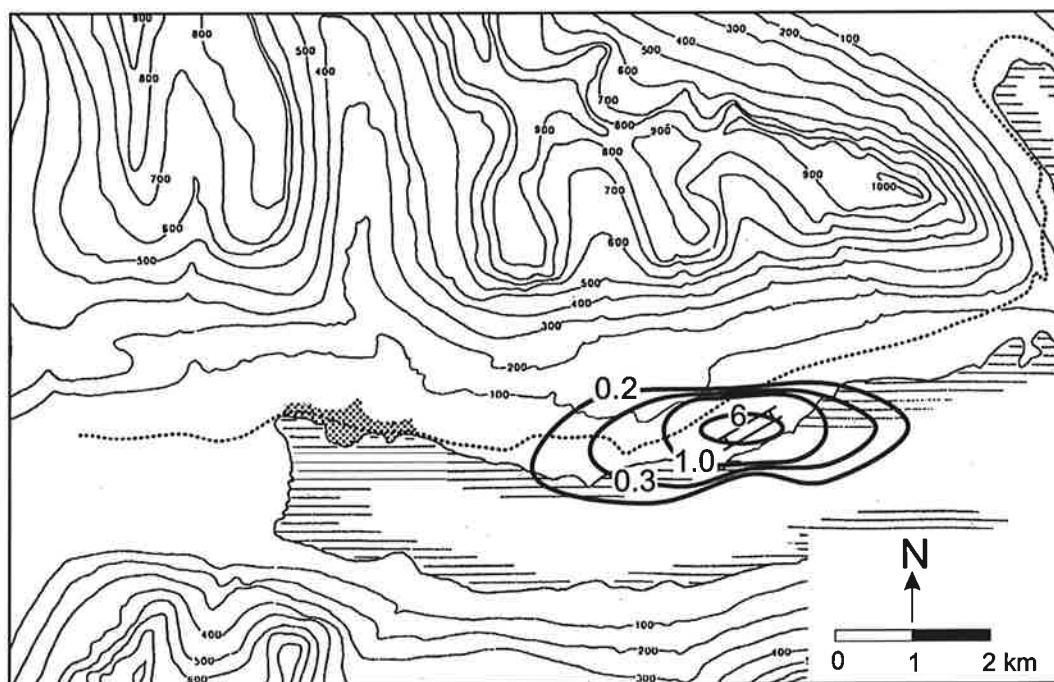


Figure 16: Long term average ground level concentrations of gaseous fluorides ( $\mu\text{g}/\text{m}^3$ ) for the growing season due to emission from ALT. 2b (240,000 t Al/y) with wet scrubber for the aluminium smelter.

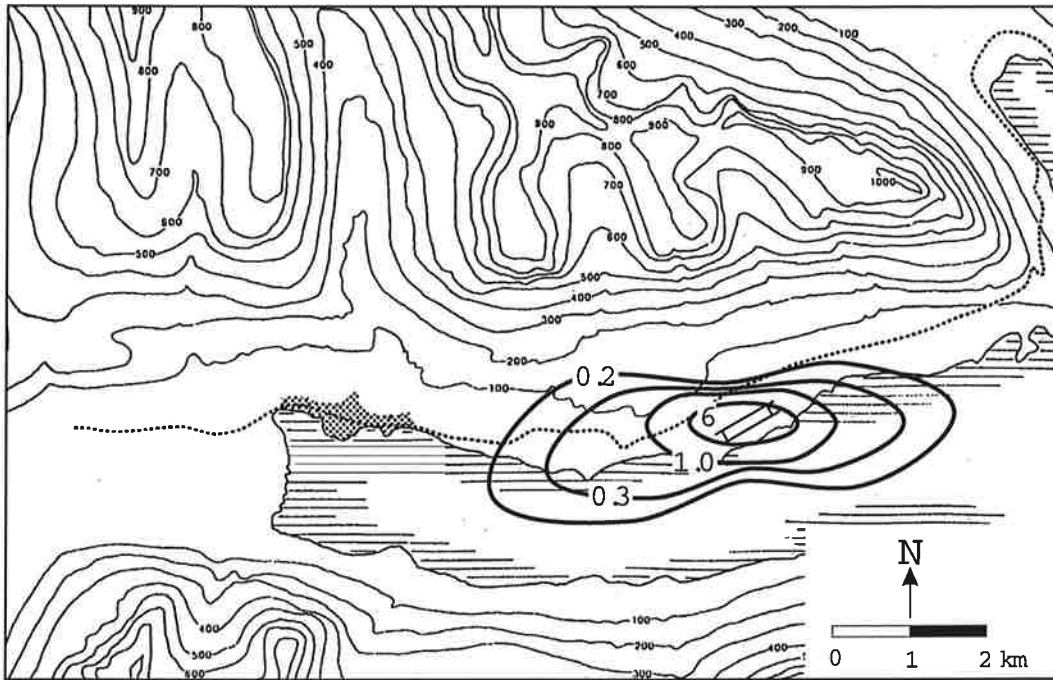


Figure 17: Long term average ground level concentrations of gaseous fluorides ( $\mu\text{g}/\text{m}^3$ ) for the growing season due to emission from ALT. 2b (240,000 t Al/y) without wet scrubber for the aluminium smelter.

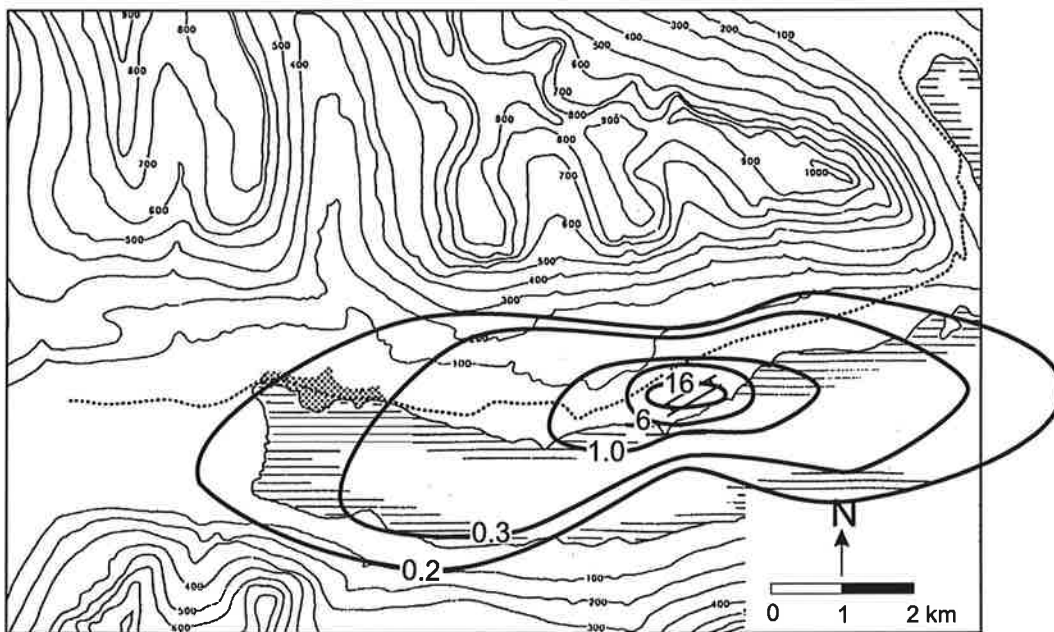


Figure 18: Long term average ground level concentrations of gaseous fluorides ( $\mu\text{g}/\text{m}^3$ ) for the growing season due to emission from ALT. 3a (360,000 t Al/y) using PARCOM for the aluminium smelter.

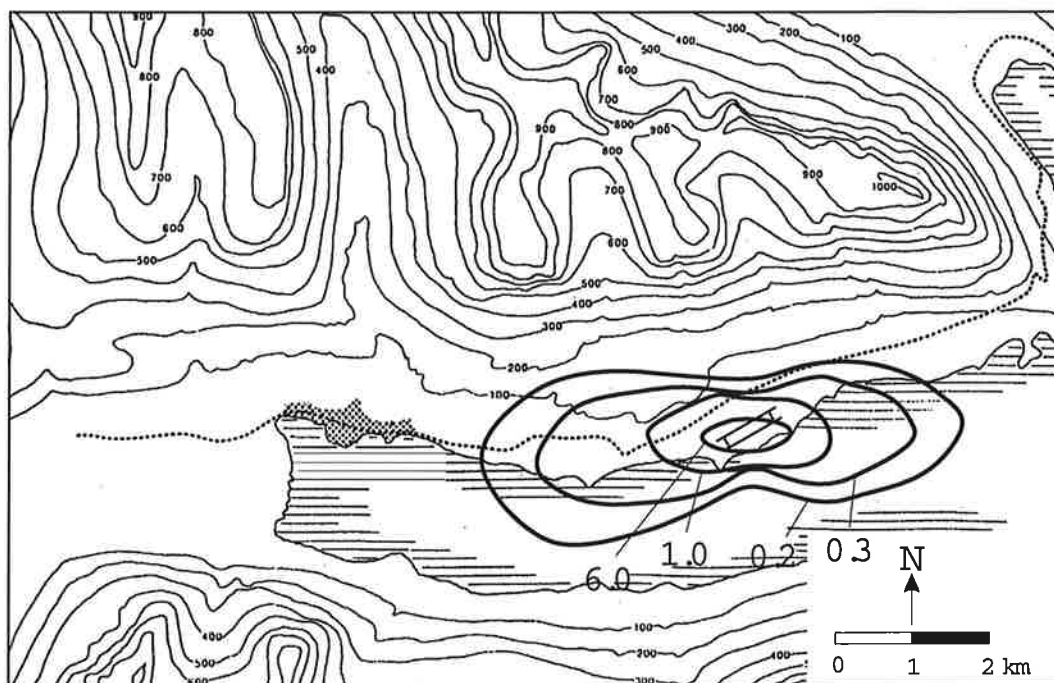


Figure 19: Long term average ground level concentrations of gaseous fluorides ( $\mu\text{g}/\text{m}^3$ ) for the growing season due to emission from ALT. 3b (360,000 t Al/y) with wet scrubber for the aluminium smelter.

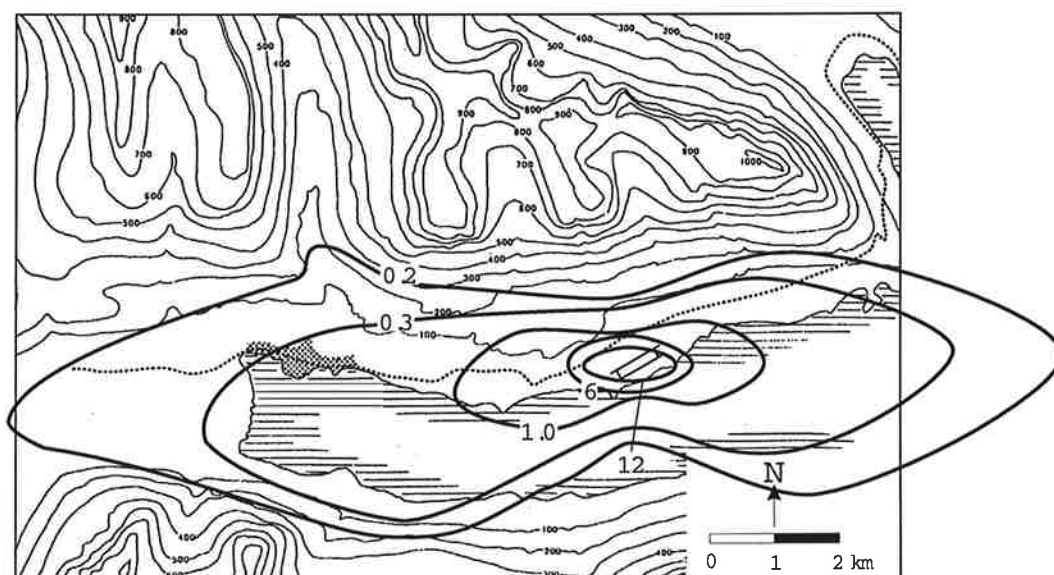
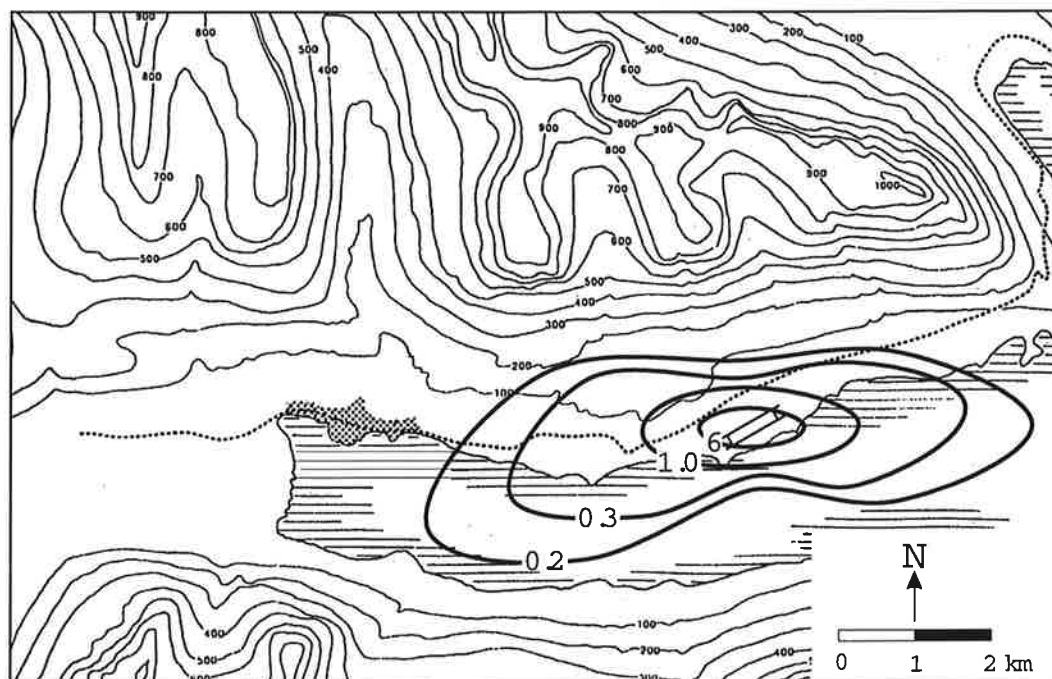


Figure 20: Long term average ground level concentrations of gaseous fluorides ( $\mu\text{g}/\text{m}^3$ ) for the growing season due to emission from ALT. 4a (480,000 t Al/y) using PARCOM for the aluminium smelter.



*Figure 21: Long term average ground level concentrations of gaseous fluorides ( $\mu\text{g}/\text{m}^3$ ) for the growing season due to emission from ALT. 4b (480,000 t Al/y) with wet scrubber for the aluminium smelter.*

## 6. Typical day with high impact of the smelter's emissions

### 6.1 Sulphur dioxide

The day chosen to calculate maximum 24 hours average concentrations of  $\text{SO}_2$  was 15 June 1984. This day was selected as a typical day with meteorological conditions that can cause a high impact of the pollution from the smelter at Budareyri (about 6 km west of the smelter), as Böhler (1990) has used in a similar study. During this day the wind was blowing stationary from the smelter in the direction of Budareyri during 75% of the time. The pollution from the smelter that reaches Budareyri is blown further west into the valley. Since the Icelandic and EU air quality guidelines for  $\text{SO}_2$  refer to human health, it is important to see the impact of the pollution from the smelter at a populated area. The meteorological matrix for this day, based upon eight observations, is given in Table 11.

$\text{SO}_2$  emissions representative of a day with high emissions, due to f.ex. maintenance on the Gas Treatment Centre, were used in the dispersion calculations for ALT. 1a, ALT. 2a, ALT. 3a and ALT. 4a. The 24 hours average concentrations of  $\text{SO}_2$  on such a day with unfavourable meteorological conditions for the population in Budareyri were also calculated for normal emissions, for all the volume production alternatives (ALT. 1b, ALT. 2b, ALT. 3b and ALT. 4b), with or without wet scrubber. The emission values are presented in table 9.





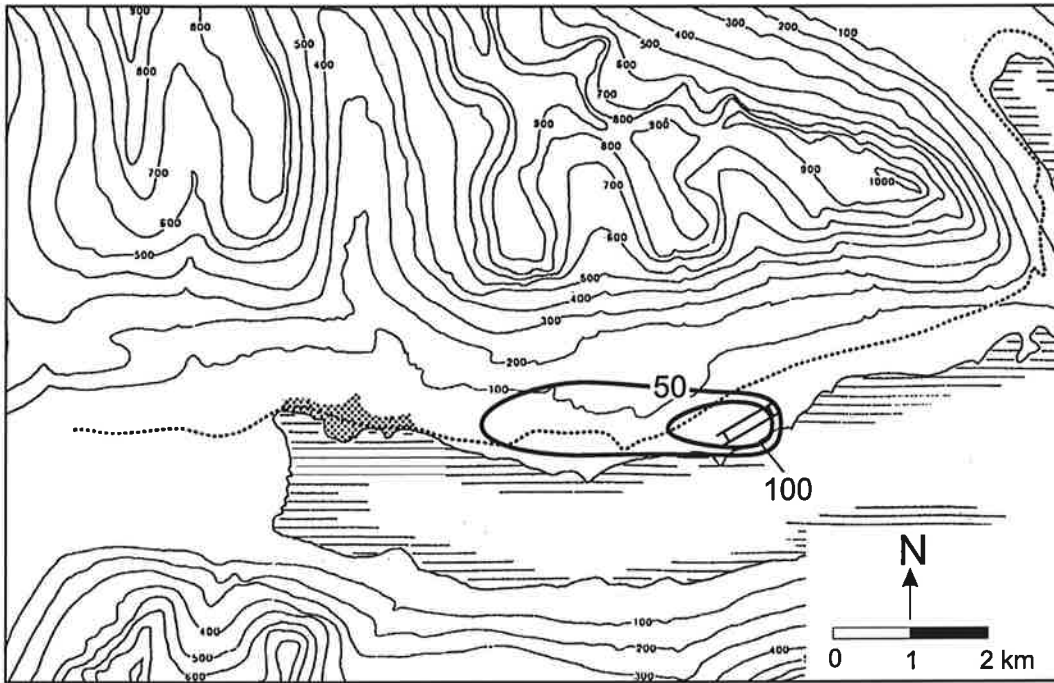


Figure 22: 24 hours average  $\text{SO}_2$  concentrations, due to high emissions from ALT. 1a (120,000 t Al/y), on a day with stationary winds from east.

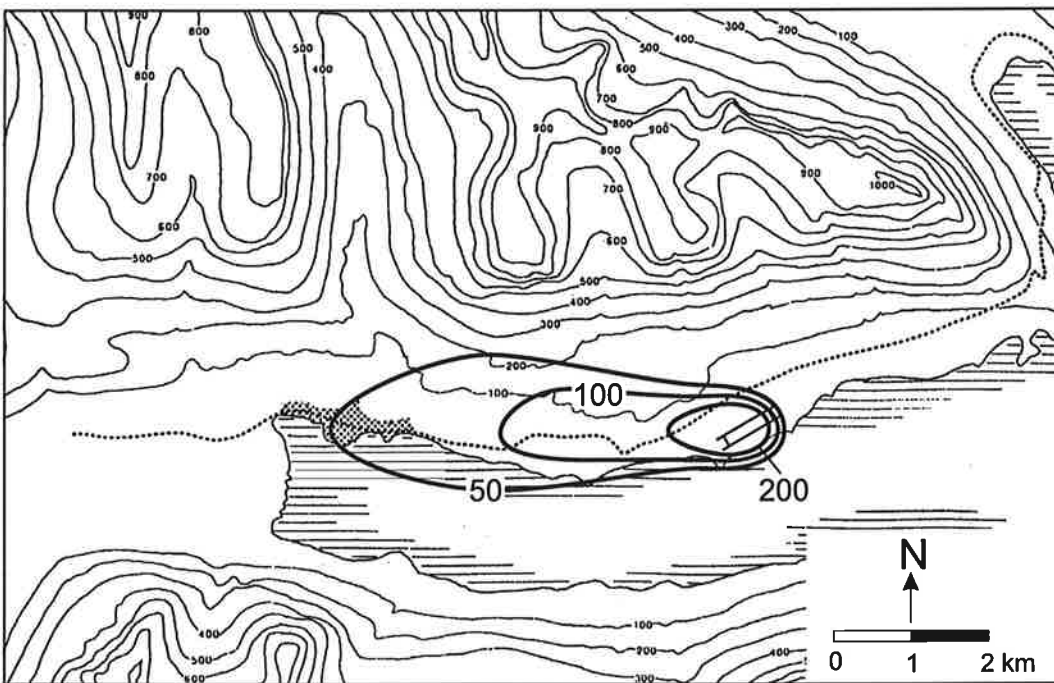


Figure 23: 24 hours average  $\text{SO}_2$  concentrations, due to high emissions from ALT. 2a (240,000 t Al/y), on a day with stationary winds from east.

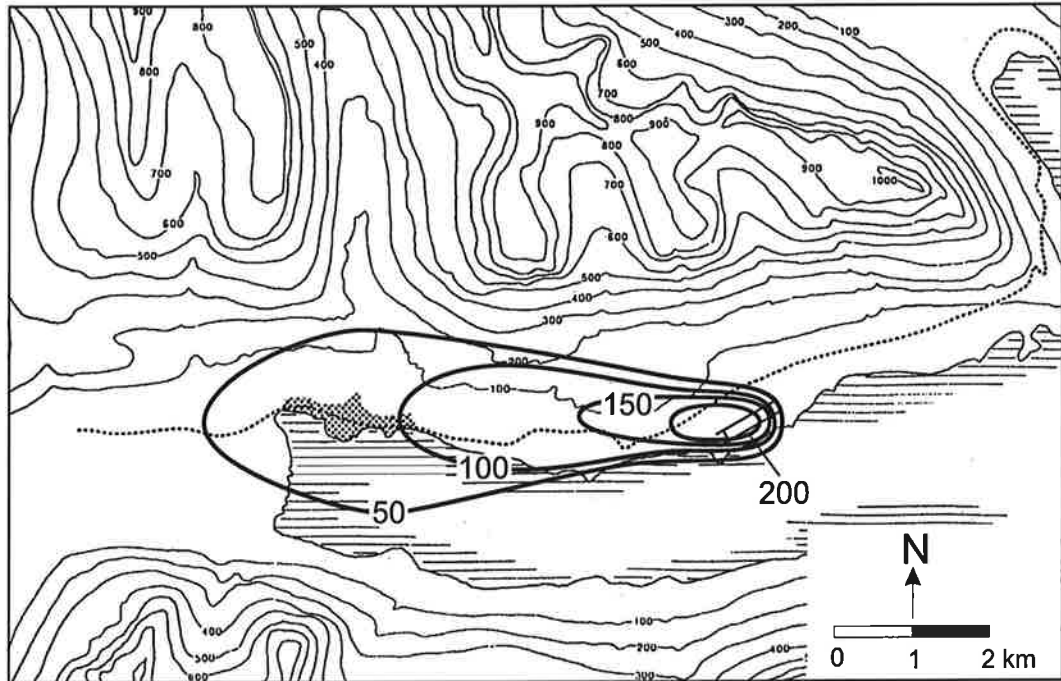


Figure 24: 24 hours average  $\text{SO}_2$  concentrations, due to high emissions from ALT. 3a (360,000 t Al/y), on a day with stationary winds from east.

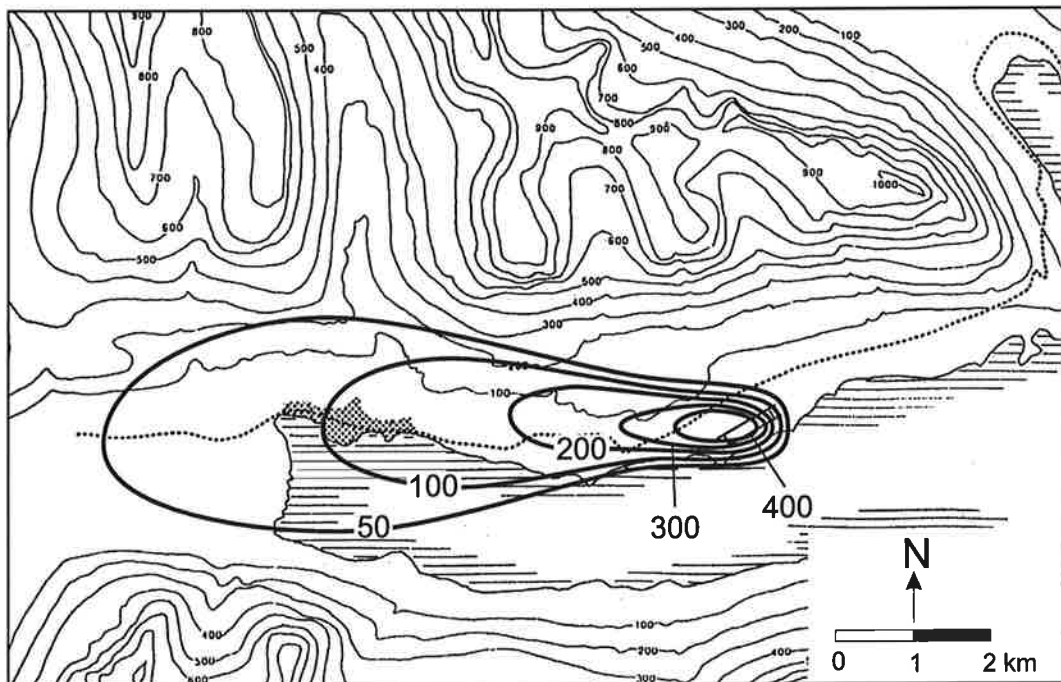
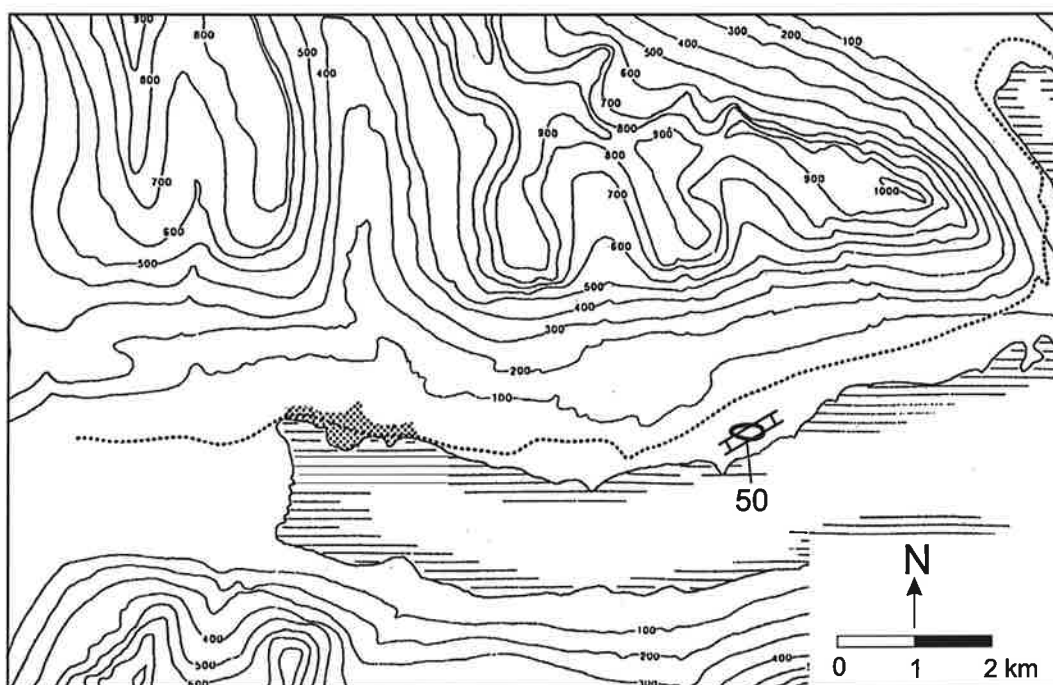


Figure 25: 24 hours average  $\text{SO}_2$  concentrations, due to high emissions from ALT. 4a (480,000 t Al/y), on a day with stationary winds from east.

The model calculations of 24 hours average of  $\text{SO}_2$  concentrations on a day with unfavourable meteorological conditions for the population in Budareyri and with

normal emissions are presented in Figures 26, 28, 30 and 31, for ALT. 1b, ALT. 2b, ALT. 3b and ALT. 4b with wet scrubber, respectively. Figures 27 and 29 present similar model calculations for ALT. 1b and ALT. 2b without wet scrubber, respectively. Exceedance of the 24 hours average limit of  $50 \mu\text{g}/\text{m}^3$  may occur up to about 0,5 km, 1,5 km and 2,5 km west of the smelter for ALT. 2b, ALT. 3b and ALT. 4b with wet scrubber, respectively, and up to about 2 km and 4 km west of the smelter for ALT. 1b and ALT. 2b without wet scrubber, respectively. Only ALT. 2b without wet scrubber may reach concentrations around  $50 \mu\text{g}/\text{m}^3$  at Budareyri's eastern border.

The probability of occurrence of a day with similar meteorological and emission conditions is about 0.3%, which is well under the maximum 2% of the time allowed, by the Icelandic guideline, to exceed  $50 \mu\text{g}/\text{m}^3$ . Never the less, in days with poor dispersion conditions, stationary winds and with  $\text{SO}_2$  emissions from a smelter greater than 120 000 t Al/y, ambient air concentrations may still exceed  $50 \mu\text{g}/\text{m}^3$ , but most probably in a considerably more restricted area than the one shown in the figures. In any case the probability of exceedance of  $50 \mu\text{g}/\text{m}^3$  in Budareyri is very small and well under 2% for all the considered alternatives.



*Figure 26: 24 hours average  $\text{SO}_2$  concentrations, due to normal emissions from ALT. 1b (120,000 t Al/y) with wet-scrubber, on a day with stationary winds from east.*

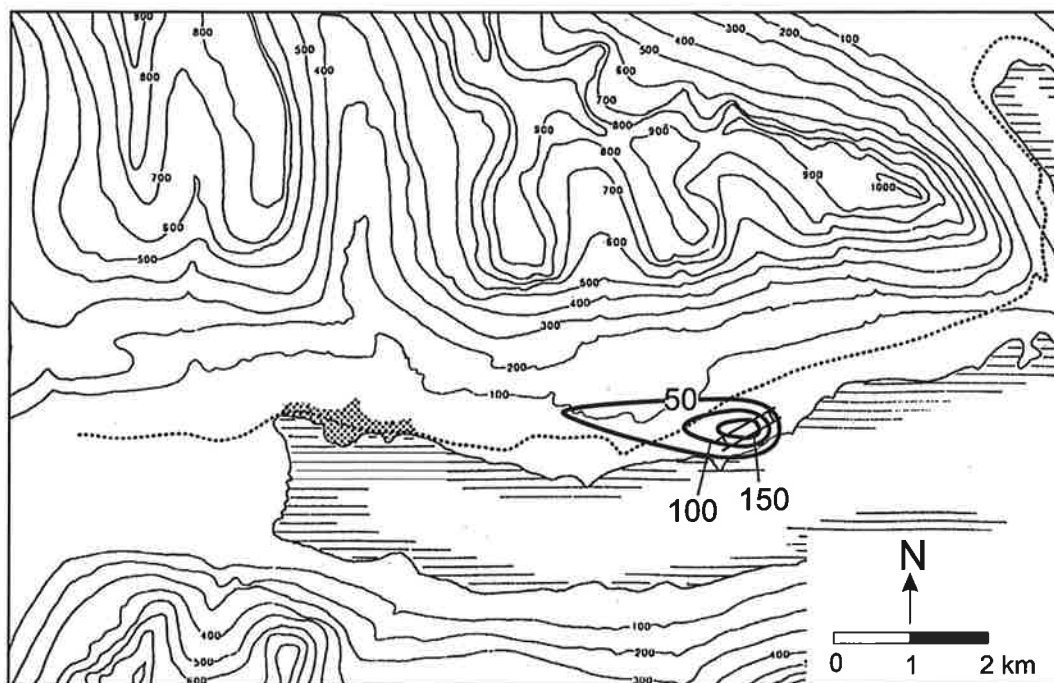


Figure 27: 24 hours average  $\text{SO}_2$  concentrations, due to normal emissions from ALT. 1b (120,000 t Al/y) without wet-scrubber, on a day with stationary winds from east.

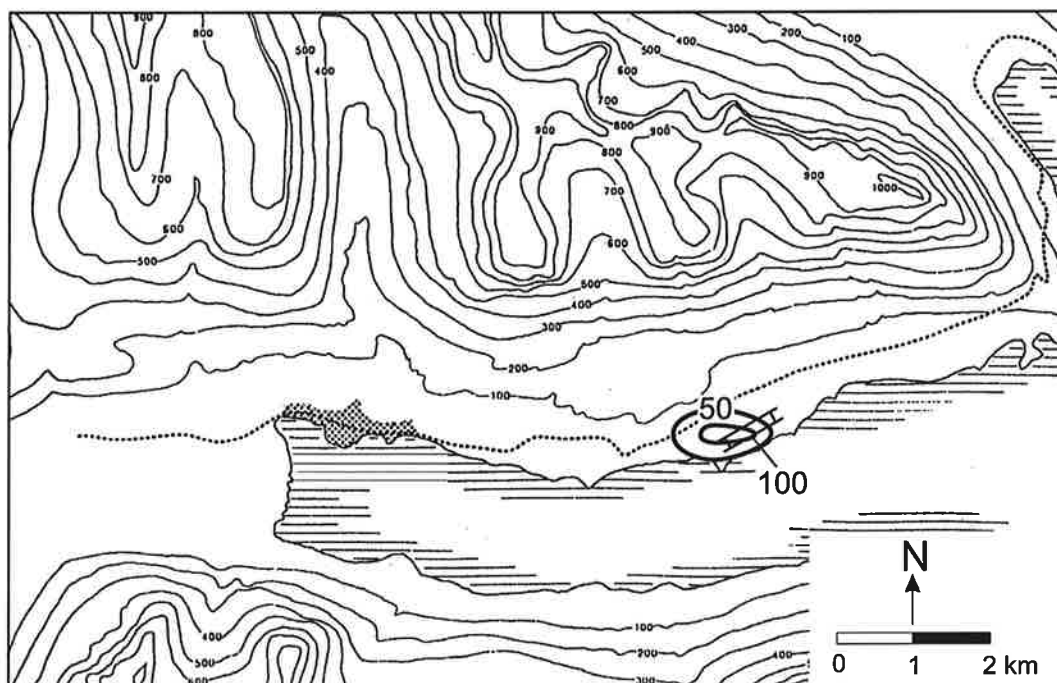
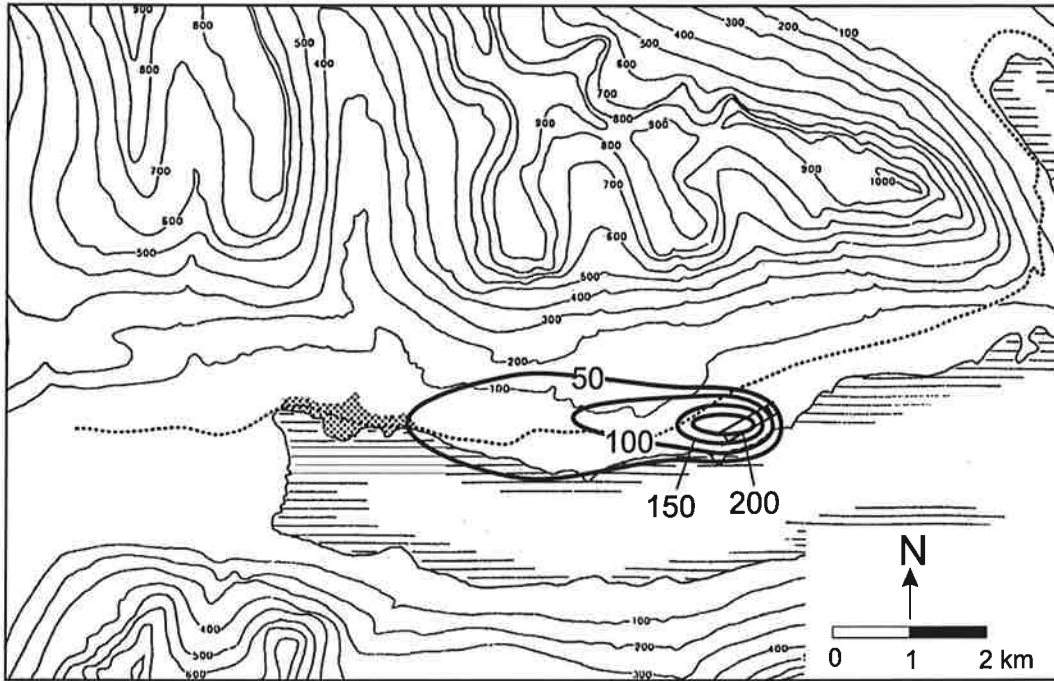
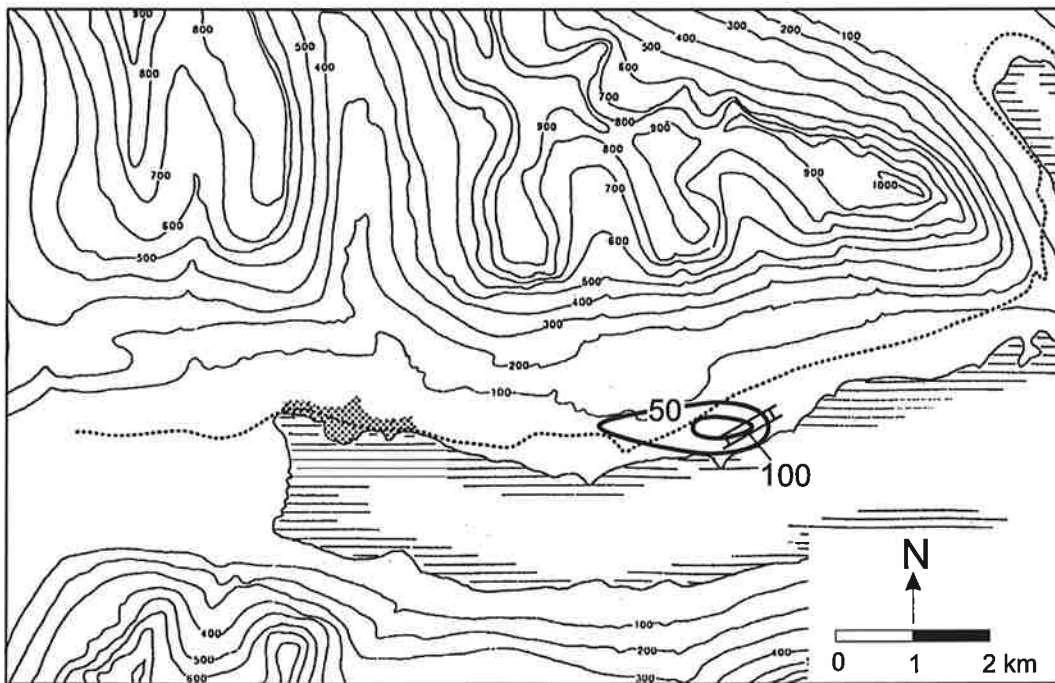


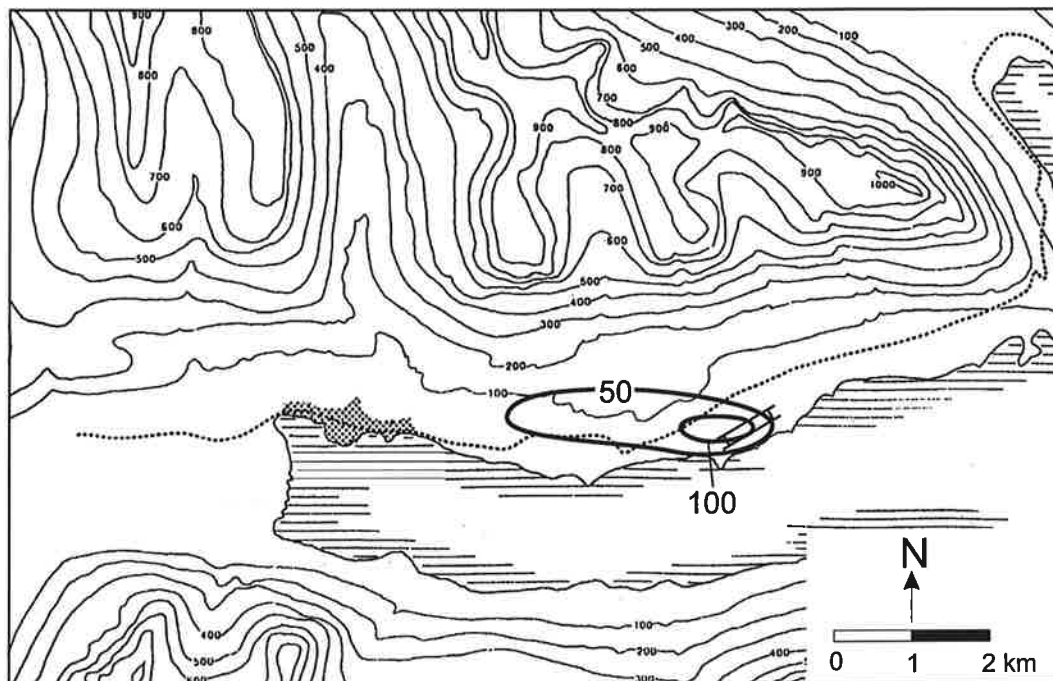
Figure 28: 24 hours average  $\text{SO}_2$  concentrations, due to normal emissions from ALT. 2b (240,000 t Al/y) with wet-scrubber, on a day with stationary winds from east.



*Figure 29: 24 hours average SO<sub>2</sub> concentrations, due to normal emissions from ALT. 2b (240,000 t Al/y) without wet-scrubber, on a day with stationary winds from east.*



*Figure 30: 24 hours average SO<sub>2</sub> concentrations, due to normal emissions from ALT. 3b (360,000 t Al/y) with wet-scrubber, on a day with stationary winds from east.*



*Figure 31: 24 hours average SO<sub>2</sub> concentrations, due to normal emissions from ALT. 4b (480,000 t Al/y) with wet-scrubber, on a day with stationary winds from east.*

## 6.2 Gaseous fluorides

The day chosen to calculate maximum 24 hours average concentrations of fluorides was 13 of November 1998. This day was selected as a typical day with poor dispersion conditions, causing high concentrations in the area around the smelter. During this day, light-stable conditions occurred in 92% of the time and stable conditions occurred in 8% of the time. The main wind directions were from east (54%) and west and west-north-west (25%). Since the most restrictive Norwegian air quality guideline for fluorides refers to vegetation, it is important to see the impact of the pollution from the smelter on the vegetation around the plant. Such an impact is highest in a day with poor dispersion conditions. The meteorological matrix for this day, based upon 24 observations, is given in Table 12.

The fluoride emissions used in the calculations of 24 hours average of fluorides are representative of a day with high emissions due, for instance, to maintenance on the Gas Treatment Centres, for the four production alternatives. These emissions are presented in table 8. In addition, a similar calculation was done for ALT.1b without wet scrubber in a day with normal emissions (emission values in Table 8).

Table 12: Joint frequency matrix of wind speed, wind direction and stability for the 13 of November 1998.

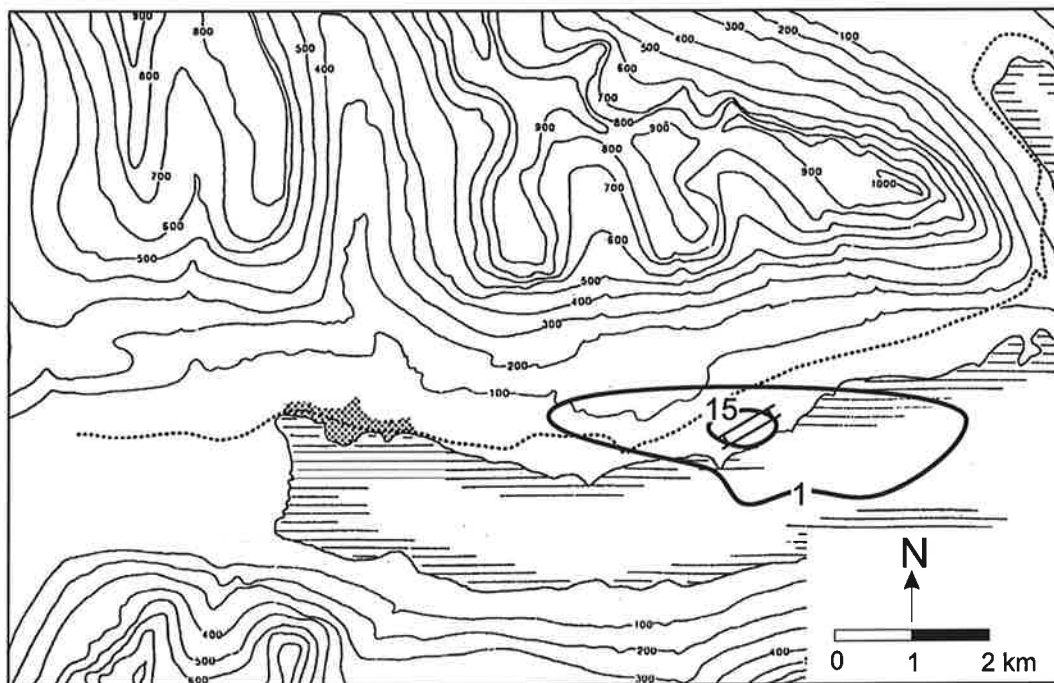
		Class I: Unstable				Class II: Neutral				Class III: Light stable				Class IV: Stable					
		DT < -0.8				-0.8 < DT < 0.0				0.0 < DT < 0.8				0.8 < DT				Grader C / 35M	
		U less or equal 0.3 m/s																	
		0.0- 2.0 m/s				2.0- 4.0 m/s				4.0- 6.0 m/s				over 6.0 m/s					
Wind-dir.		I	II	III	IV	I	II	III	IV	I	II	III	IV	I	II	III	IV	Rose	
30		0.0	0.0	0.0	0.0	0.0	0.0	4.2	0.0	0.0	0.0	0.0	0.0	0.0	0.0	0.0	0.0	4.2	
60		0.0	0.0	0.0	0.0	0.0	0.0	0.0	0.0	0.0	0.0	0.0	0.0	0.0	0.0	0.0	0.0	0.0	
90		0.0	0.0	0.0	0.0	0.0	0.0	4.2	0.0	0.0	0.0	8.3	0.0	0.0	0.0	41.7	0.0	54.2	
120		0.0	0.0	0.0	0.0	0.0	0.0	0.0	0.0	0.0	0.0	0.0	0.0	0.0	0.0	4.2	0.0	4.2	
150		0.0	0.0	0.0	0.0	0.0	0.0	0.0	0.0	0.0	0.0	0.0	0.0	0.0	0.0	0.0	0.0	0.0	
180		0.0	0.0	0.0	0.0	0.0	0.0	0.0	0.0	0.0	0.0	0.0	0.0	0.0	0.0	0.0	0.0	0.0	
210		0.0	0.0	0.0	0.0	0.0	0.0	0.0	0.0	0.0	0.0	0.0	0.0	0.0	0.0	0.0	0.0	0.0	
240		0.0	0.0	0.0	0.0	0.0	0.0	0.0	0.0	0.0	0.0	0.0	0.0	0.0	0.0	0.0	0.0	0.0	
270		0.0	0.0	0.0	4.2	0.0	0.0	4.2	4.2	0.0	0.0	0.0	0.0	0.0	0.0	0.0	0.0	12.6	
300		0.0	0.0	8.3	0.0	0.0	0.0	4.2	0.0	0.0	0.0	0.0	0.0	0.0	0.0	0.0	0.0	12.5	
330		0.0	0.0	0.0	0.0	0.0	0.0	0.0	0.0	0.0	0.0	0.0	0.0	0.0	0.0	0.0	0.0	0.0	
360		0.0	0.0	0.0	0.0	0.0	0.0	4.2	0.0	0.0	0.0	8.3	0.0	0.0	0.0	0.0	0.0	12.5	
Calm		0.0	0.0	0.0	0.0													0.0	
Total		0.0	0.0	8.3	4.2	0.0	0.0	21.0	4.2	0.0	0.0	16.6	0.0	0.0	0.0	45.9	0.0	100.0	
Occurrence		12.5 %				25.2 %				16.6 %				45.9 %					
Wind speed		1.7 m/s				2.9 m/s				5.3 m/s				7.5 m/s					

Frequency of occurrence of the stability classes

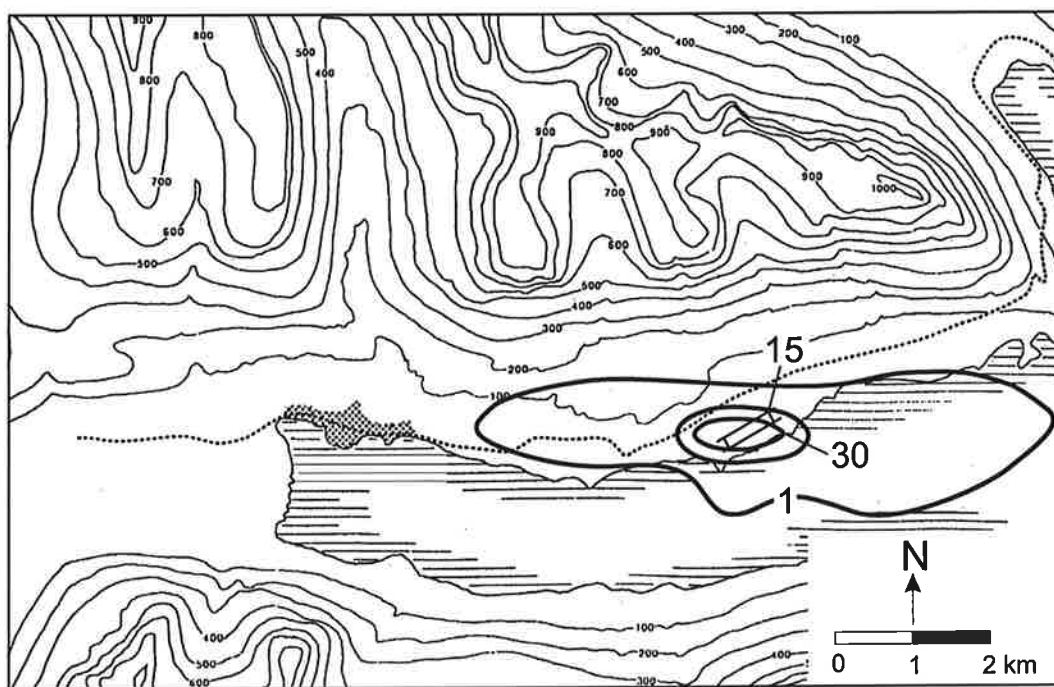
	Class I	Class II	Class III	Class IV	
Occurrence	0.0 %	0.0 %	91.8 %	8.2 %	100.0 %

The results of the model calculations for 24 hours average fluoride concentrations are presented in Figures 32, 33, 34 and 35, for ALT. 1, ALT. 2, ALT. 3 and ALT. 4 in a day with high emissions, respectively, and in Fig. 36 for ALT.1b without wet scrubber, in a day with normal emissions. The Norwegian air quality guideline for human health, for 24 hours average of total fluorides is  $25 \mu\text{g}/\text{m}^3$ . This corresponds to  $15 \mu\text{g}/\text{m}^3$  of gaseous fluorides, assuming 60% of fluorides in the gas phase. Only gaseous fluorides are presented in the figures.

Figures 32 to 35 show that the Norwegian air quality guideline for human health ( $25 \mu\text{g}/\text{m}^3$ , corresponding to  $15 \mu\text{g}/\text{m}^3$  in the figures) may be exceeded in a restricted area outside the smelter area for ALT. 2, ALT. 3 and ALT. 4. The Norwegian air quality guideline for vegetation ( $1 \mu\text{g}/\text{m}^3$ ) may be exceeded up to about 2 km, 3.0 km, 3.5 km and 3.8 km west of the smelter, and up to about 2.3 km, 3.5 km, 4.0 km and 4.5 km east of the smelter, for ALT. 1, ALT. 2, ALT. 3 and ALT. 4, respectively.

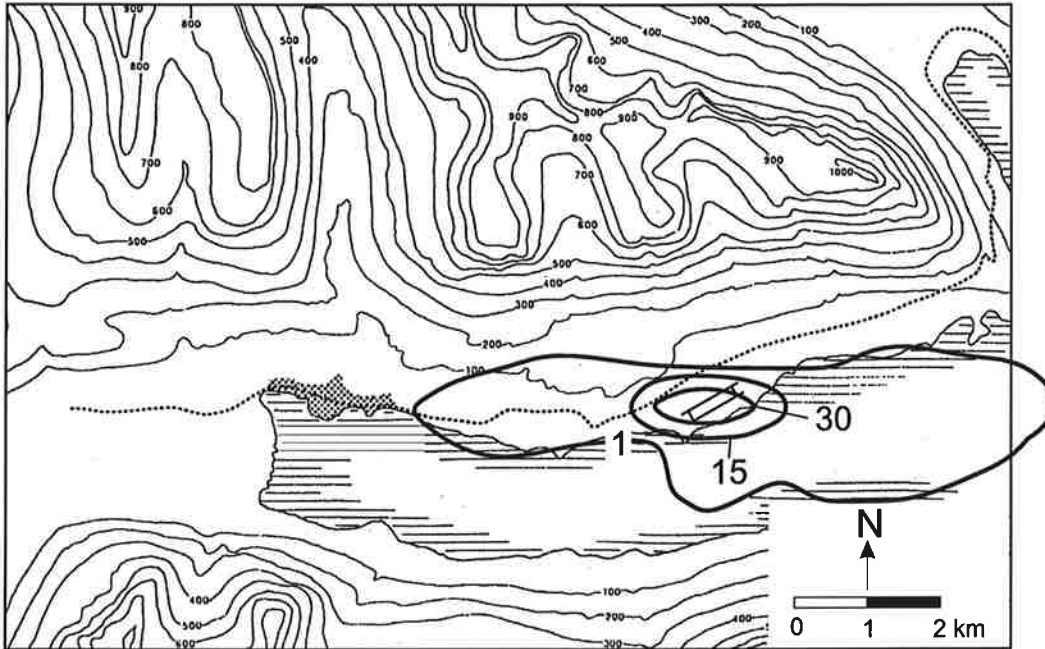


*Figure 32: 24 hours average of gaseous fluorides concentrations, due to high emissions from ALT. 1 (120,000 t Al/y), on a day with poor dispersion conditions.*

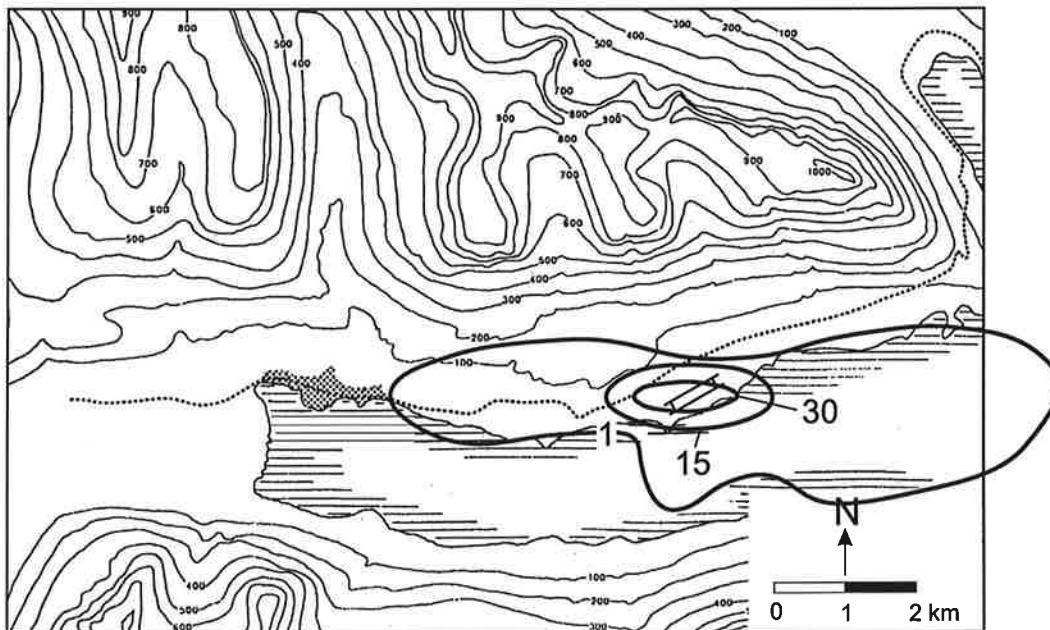


*Figure 33: 24 hours average of gaseous fluorides concentrations, due to high emissions from ALT. 2 (240,000 t Al/y), on a day with poor dispersion conditions.*



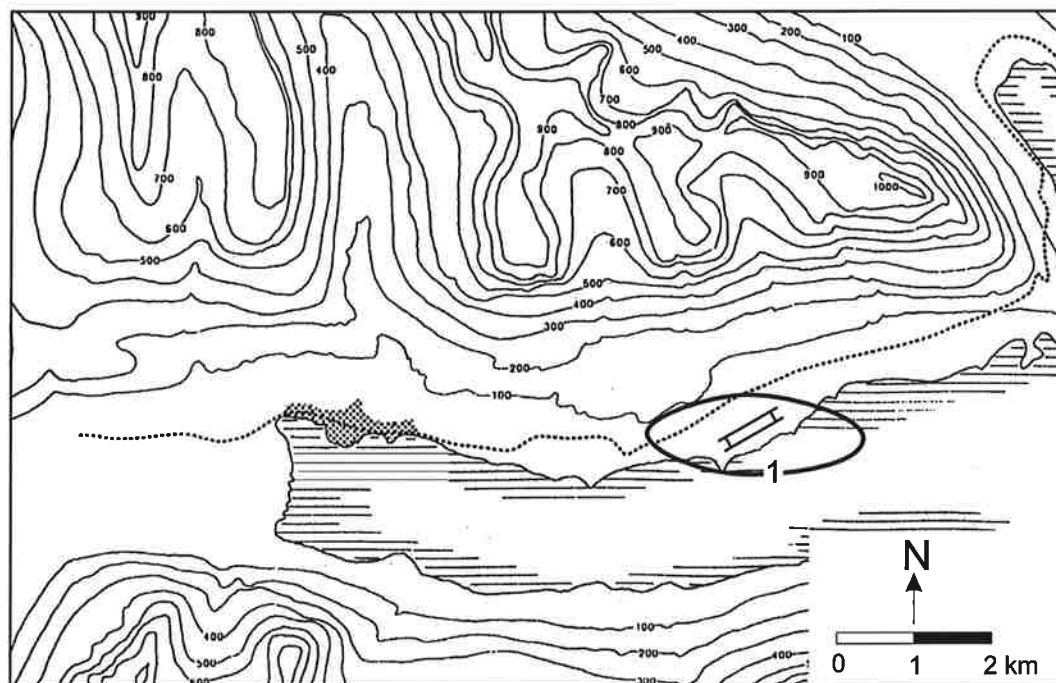


*Figure 34: 24 hours average of gaseous fluorides concentrations, due to high emissions from ALT. 3 (360,000 t Al/y), on a day with poor dispersion conditions.*



*Figure 35: 24 hours average of gaseous fluorides concentrations, due to high emissions from ALT. 4 (480,000 t Al/y), on a day with poor dispersion conditions.*

Figure 36 shows that the Norwegian air quality guideline for human health ( $25 \mu\text{g}/\text{m}^3$ , corresponding to  $15 \mu\text{g}/\text{m}^3$  in the figure) will not be exceeded for normal emissions from ALT. 1b without wet scrubber. The Norwegian air quality guideline for vegetation ( $1 \mu\text{g}/\text{m}^3$ ) may be exceeded up to about 1 km west of the smelter and up to about 1 km east of the smelter.



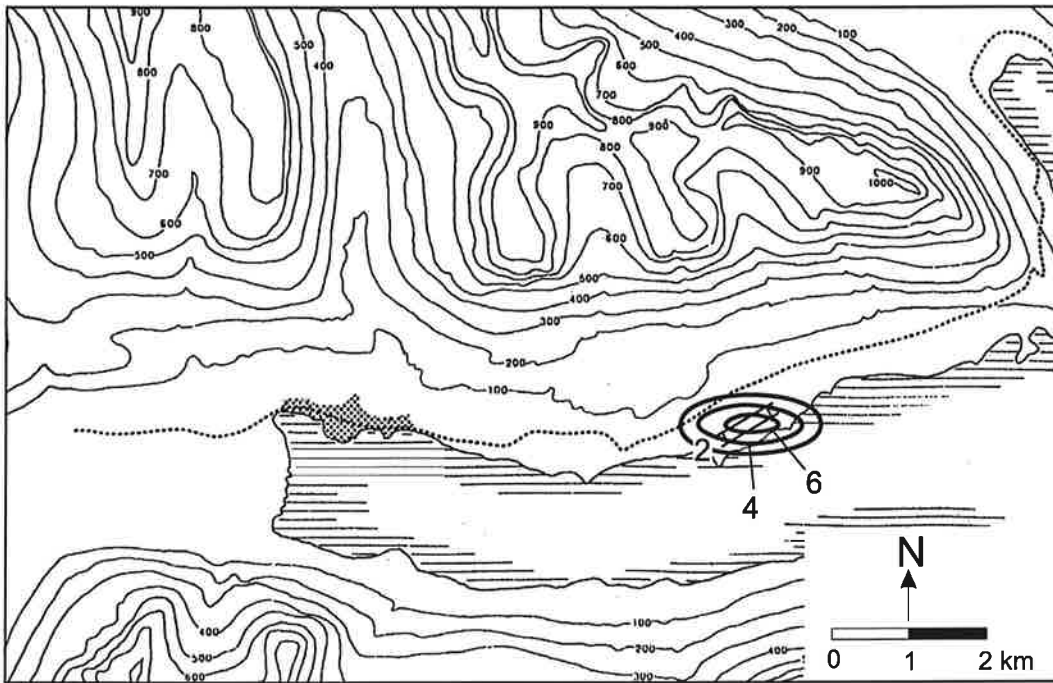
*Figure 36: 24 hours average of gaseous fluorides concentrations, due to normal emissions from ALT. 1b (120,000 t Al/y) without wet scrubber, on a day with poor dispersion conditions.*

## 7. Model calculations for PM10

### 7.1 Long term average concentration

The long term average calculation of PM10 concentrations has been carried out for the largest production alternative (ALT. 4a), in order to identify if emissions of PM10 would meet the ambient air quality guidelines for all the alternatives. The emission data is given in Tables 3 and 7. One year of available meteorological data was used (Table 2) and the result was compared with the EU guideline for one year.

The result of the calculation for ALT. 4a is given in Figure 37.



*Figure 37: Annual average PM10 concentrations ( $\mu\text{g}/\text{m}^3$ ) due to emissions from the alternative with highest PM10 emissions (ALT. 4a with 480,000 t Al/y).*

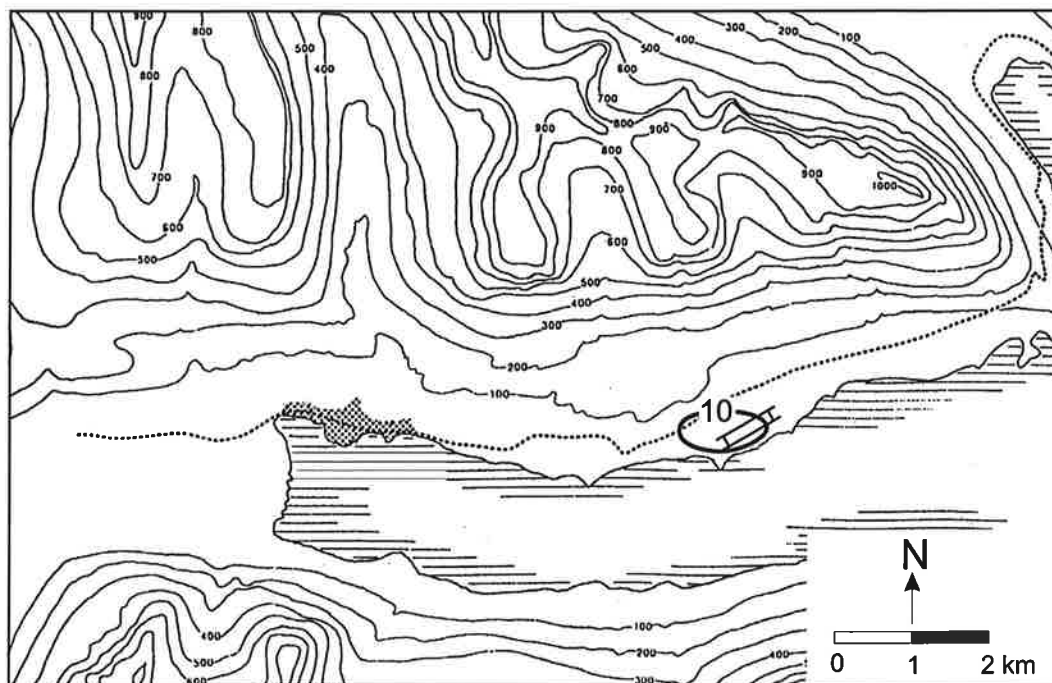
The figure shows that the highest PM10 concentration for the alternative with highest PM10 emissions (ALT. 4a) is well under the EU air quality guideline for one year average of PM10 ( $20 \mu\text{g}/\text{m}^3$ ). From this result it can be concluded that all the other emission alternatives for PM10, presented in Table 7, will not exceed the referred EU air quality guideline.

## 7.2 Typical day with high impact of the smelter's emissions

The day chosen to calculate a maximum 24 hours average concentration of PM10 was 15 June 1984, as for  $\text{SO}_2$ , in order to see the impact of the pollution from the smelter at the closest populated area, Budareyri. The result is compared to the EU air quality guideline for human health for 24 hours average PM10.

The 24 hours average calculation of PM10 has been carried out for the largest production alternative (ALT. 4). The objective was to identify if high emissions of PM10, in a typical day with high impact of the pollution from the smelter at Budareyri, would meet the ambient air quality guidelines for all the alternatives. The emission data for a day with high emissions, due to for instance maintenance on the Gas Treatment Centres, is given in Table 10.

The result of the calculation for ALT. 4 is given in Figure 38.



*Figure 38: 24 hours average PM10 concentrations, due to emissions from the alternative with highest PM10 emissions (ALT. 4 with 480,000 t Al/y) for the planned aluminium smelter, on a day with stationary winds from east.*

The figure shows that the calculated PM10 concentration for the alternative with highest PM10 emissions (ALT. 4) is well under the EU air quality guideline for 24 hours average of PM10 ( $50 \mu\text{g}/\text{m}^3$ ). From this result it can be concluded that all the other emission alternatives for PM10, presented in Table 10, will not exceed the referred EU air quality guideline.

## 8. Conclusions

The Norwegian Institute for Air Research (NILU) has carried out a comparison of recent meteorological measurements at Hraun in Reydarfjörður with earlier measurements at Sómastadagerdi in Reydarfjörður and at Mjöeyri in Eskifjörður, in the eastern part of Iceland, and has updated the model calculations for a planned aluminium smelter at Hraun using the meteorological measurements at Hraun.

The dispersion model calculations for the planned aluminium smelter have been done in order to assess the potential dispersion of sulphur dioxide, fluorides and PM10 for four production alternatives: 120,000 (ALT. 1), 240,000 (ALT. 2), 360,000 (ALT. 3) and 480,000 (ALT. 4) tons of aluminium per year. Calculations have been done for these four alternatives with a dry scrubber and with both a dry and a wet scrubber, using the anticipated design values for the smelter emissions. Finally emissions from the various production alternatives have been calculated according to The Oslo and Paris Commission (PARCOM) definition of Best Available Technology (BAT) and its emission guidelines for new prebake lines

built after 1999. The objective of the dispersion calculations has been to assess whether the relevant air quality guidelines are met.

The wind measurements carried out at Somastadagerdi in 1984 are comparable with the recent wind measurements at Hraun. Both measurement years/ stations show a strong channelling effect along the east-west oriented valley axis (ca. 41% at Hraun and ca. 39% at Somastadagerdi). The average wind speed for one year was 4.5 m/s at Hraun and 4.1 m/s at Somastadagerdi. The predominant wind was down valley winds from west (about 24% of time at Hraun and about 20% of the time at Somastadagerdi). Onland winds (sea-breeze) from east occurred in about 17% of time at Hraun and about 19% of time at Somastadagerdi, mostly during daytime hours.

The stability measurements carried out at Mjöeyri in Eskifjörður and used in previous dispersion calculations have overestimated the occurrence of stable conditions during daytime hours in the summer and unstable conditions during the winter period. The recent stability measurements carried out at Hraun in Reydarfjörður seem to give a good description of the stability conditions where the planned aluminium factory will be built and were used to update the dispersion calculations.

Taking into account the uncertainties in performing dispersion estimates, such as source definition, plume rise, building effects, dispersion parameters etc., the following conclusions can be drawn:

- The *one year averaged*  $SO_2$  concentration, due to emissions from the planned smelter, will not exceed the EU air quality guideline ( $20 \mu\text{g}/\text{m}^3$ ) outside the smelter industrial area for ALT. 1b, ALT. 2b and ALT. 3b with wet scrubber and for ALT. 1b without wet scrubber. ALT. 4b with wet scrubber and ALT. 2b without wet scrubber may exceed the EU guideline up to 0.5 km and 1.0 km west and 0.5 km and 0.9 km east from the smelter, respectively.
- Dispersion calculations of *gaseous fluorides for the growing season* showed that the Norwegian air quality guideline for vegetation ( $0.3 \mu\text{g}/\text{m}^3$ ) might be exceeded up to about:
  - 2 km, 3.2 km, 4.5 km and 9.5 km west of the smelter and up to about 1.3 km, 2.5 km, 3.5 km and 4.5 km east of the smelter for the PARCOM /BAT ALT. 1a, ALT. 2a, ALT. 3a and ALT. 4a, respectively;
  - 0.8 km, 1.5 km, 2.0 km and 2.7 km west of the smelter and up to about 0.5 km, 1.2 km, 1.5 km and 2.1 km east of the smelter for ALT. 1b, ALT. 2b, ALT. 3b and ALT. 4b with wet scrubber, respectively;
  - 1 km and 2.1 km west of the smelter and up to about 0.8 km and 1.5 km east of the smelter for ALT. 1b and ALT. 2b without wet scrubber, respectively.
- The calculated *total fluorides average for 6 months* exceeded the Norwegian air quality guideline for human health ( $10 \mu\text{g}/\text{m}^3$ ) up to 0.4 km, 0.5 km and 0.5 km west and 0.3 km, 0.4 km and 0.4 km east from the smelter buildings for the PARCOM /BAT ALT. 2a, ALT. 3a and ALT. 4a, respectively.

- On a typical day with unfavourable meteorological conditions for the population in Budareyri and with high SO<sub>2</sub> emissions, the Icelandic guideline (50 µg/m<sup>3</sup>) may be exceeded up to about 3 km, 5 km, 6,5 km and 7,8 km west of the smelter for ALT. 1a, ALT. 2a, ALT. 3a and ALT. 4a, respectively. The Icelandic air quality guideline of 50 µg/m<sup>3</sup> for 24 hour SO<sub>2</sub> concentrations can be exceeded up to 2% of the time. The probability of occurrence of a day with similarly adverse meteorological and emission conditions is less than 0.003%.
- On a typical day with unfavourable meteorological conditions for the population in Budareyri and with normal SO<sub>2</sub> emissions, the Icelandic guideline (50 µg/m<sup>3</sup>) may be exceeded up to about 0,5 km, 1,5 km and 2,5 km west of the smelter for ALT. 2b, ALT. 3b and ALT. 4b with wet scrubber, respectively, and up to about 2 km and 4 km west of the smelter for ALT. 1b and ALT. 2b without wet scrubber, respectively. Only ALT. 2b without wet scrubber may reach concentrations around 50 µg/m<sup>3</sup> at Budareyri's eastern border. The Icelandic air quality guideline of 50 µg/m<sup>3</sup> for 24 hour SO<sub>2</sub> concentrations can be exceeded up to 2% of the time. The probability of exceedance of 50 µg/m<sup>3</sup> in Budareyri is well under 2%.
- On a typical day with high fluoride emissions from the smelter and poor dispersion conditions, the Norwegian air quality guideline for human health (25 µg/m<sup>3</sup>) may be exceeded in a restricted area outside the smelter area for ALT. 2, ALT. 3 and ALT. 4. The Norwegian air quality guideline for vegetation (1 µg/m<sup>3</sup>) may be exceeded, in such a day, up to about 2 km, 3.0 km, 3.5 km and 3.8 km west of the smelter, and up to about 2.3 km, 3.5 km, 4.0 km and 4.5 km east of the smelter, for ALT. 1, ALT. 2, ALT. 3 and ALT. 4, respectively. The situation with high emissions of fluorides may occur 1 to 4 times a year for only a few hours each time.

Particulate matter under 10 µm (PM<sub>10</sub>) has been assessed for the largest production alternative in order to identify if emissions of PM<sub>10</sub> would meet the ambient air quality guidelines for all the alternatives. Calculations were done for one year and for a typical day with high impact of pollution from the smelter at Budareyri. These calculations showed that the EU air quality guideline for one year average of PM<sub>10</sub> (20 µg/m<sup>3</sup>) and the EU air quality guideline for 24 hours average of PM<sub>10</sub> (50 µg/m<sup>3</sup>) will not be exceed by any of the smelter's alternatives.

## 9. References

- Acid News (1997) Results from national forest-damage surveys 1986-1995. Percentage of trees in Classes 2-4 (defoliation > 25 per cent). All species. *Acid News*, 1997, 4-5, 15.
- Bøhler, T. (1987) Users guide for the Gaussian type dispersion models CONCX and CONDEP. Lillestrøm (NILU TR 8/87).

Bøhler, T. (1990) Model calculations for a planned aluminium smelter at Reydarfjörður, Iceland. Lillestrøm (NILU OR 34/90).

Guerreiro, C. and Tshukudu, T. (1998) Model calculations for a planned aluminium smelter at Hraun, Iceland. Lillestrøm (NILU OR 3/98).

Environmental and Food Agency of Iceland (1994) Regulations on environmental pollution control nr. 48/1994 (with changes nr. 378/1994 and nr. 536/1994).

Sigurdsson, F.H., and Hjartarson, H. (1986) Vedurathuganir a Reydarfjardarsvædinu. Reykjavik.

## **Appendix A**

### **Statistics for the wind speed and wind direction at Hraun**



Station : Hraun  
 Periode : YEAR - 01.05.98 - 31.05.99

DIURNAL VARIATION OF WIND DIRECTIONS (%)

*) Wind-direction	Hours									Wind-rose
	01	04	07	10	13	16	19	22		
30	3.6	5.4	1.3	1.5	0.8	1.5	2.0	5.1	2.7	
60	12.1	13.3	11.9	8.6	11.4	13.1	20.0	18.0	13.6	
90	8.5	8.2	12.4	20.5	23.8	28.0	21.5	9.4	16.7	
120	3.3	2.0	6.6	6.1	5.6	7.1	6.6	5.1	5.2	
150	1.5	1.3	1.8	2.0	2.5	2.5	1.0	2.5	1.8	
180	1.3	1.8	2.0	1.0	1.3	1.0	0.5	0.5	1.3	
210	2.1	1.8	2.8	2.8	2.3	2.5	1.3	2.5	2.1	
240	6.4	8.2	8.9	12.9	8.9	5.1	5.8	6.1	8.1	
270	27.7	32.5	30.7	27.3	22.3	16.7	19.0	24.1	24.6	
300	19.2	15.3	13.5	10.1	11.9	14.6	14.4	15.5	14.6	
330	6.2	3.1	3.0	3.8	3.5	4.0	4.1	4.3	4.1	
360	3.6	3.8	3.0	3.3	4.8	3.0	3.0	3.0	3.4	
Calm	4.6	3.3	2.0	0.3	1.0	0.8	0.8	3.8	1.9	
N. obs	( 390)	( 391)	( 394)	( 396)	( 395)	( 396)	( 395)	( 394)	(9464)	
Average wind m/s	4.2	4.4	4.7	4.9	5.2	5.0	4.6	4.2	4.7	

DISTRIBUTION OF WINDSPEED WITH WIND DIRECTIONS (%)

Class I: Windspeed 0.4 - 2.0 m/s  
 Class II: Windspeed 2.1 - 4.0 m/s  
 Class III: Windspeed 4.1 - 6.0 m/s  
 Class IV: Windspeed > 6.0 m/s

*) Wind-direction	Classes				Total	Nobs	Average wind m/s
	I	II	III	IV			
30	1.9	0.6	0.1	0.0	2.7	( 255)	1.8
60	3.5	4.6	2.9	2.6	13.6	(1286)	3.9
90	3.1	5.6	4.7	3.3	16.7	(1580)	4.4
120	1.5	1.4	1.3	1.0	5.2	( 496)	3.8
150	0.9	0.5	0.4	0.1	1.8	( 174)	2.7
180	0.5	0.5	0.2	0.1	1.3	( 121)	3.1
210	0.9	0.7	0.4	0.1	2.1	( 195)	2.8
240	3.7	2.2	0.9	1.3	8.1	( 762)	3.2
270	4.8	4.2	4.2	11.4	24.6	(2332)	5.8
300	3.1	2.3	2.5	6.6	14.6	(1378)	6.2
330	1.1	0.8	0.9	1.3	4.1	( 388)	5.0
360	0.9	0.5	0.5	1.5	3.4	( 319)	6.1
Calm					1.9	( 178)	
Total	25.8	23.8	19.0	29.5	100.0	(9464)	
Average wind m/s	1.2	3.0	5.0	9.1			4.7

\*) This number indicates central direction of sector

Stasjon : Hraun  
 Periode : WINTER - 01.12.98 - 28.02.99

DIURNAL VARIATION OF WIND DIRECTIONS (%)

*) Wind-direction	Hours									Wind-rose
	01	04	07	10	13	16	19	22		
30	2.2	2.2	4.4	4.4	1.1	2.2	3.3	4.4	2.9	
60	7.8	11.1	11.1	8.9	11.2	12.2	8.9	11.1	9.9	
90	10.0	10.0	10.0	10.0	6.7	14.4	13.3	6.7	10.1	
120	5.6	2.2	5.6	5.6	4.5	3.3	3.3	7.8	4.3	
150	1.1	1.1	1.1	1.1	4.5	3.3	1.1	2.2	1.9	
180	0.0	2.2	2.2	0.0	0.0	0.0	0.0	0.0	1.2	
210	1.1	1.1	3.3	2.2	2.2	2.2	1.1	3.3	2.3	
240	7.8	3.3	5.6	7.8	5.6	5.6	3.3	3.3	5.6	
270	31.1	38.9	32.2	34.4	36.0	23.3	31.1	28.9	31.9	
300	23.3	20.0	15.6	15.6	20.2	21.1	21.1	23.3	19.6	
330	6.7	2.2	4.4	4.4	4.5	6.7	7.8	7.8	6.0	
360	3.3	3.3	4.4	5.6	3.4	5.6	5.6	1.1	3.9	
Calm	0.0	2.2	0.0	0.0	0.0	0.0	0.0	0.0	0.4	
N. obs	( 90)	( 90)	( 90)	( 90)	( 89)	( 90)	( 90)	( 90)	(2158)	
Average wind m/s	5.5	5.5	5.7	5.4	5.7	5.4	5.5	5.7	5.6	

DISTRIBUTION OF WINDSPEED WITH WIND DIRECTIONS (%)

Class I: Windspeed 0.4 - 2.0 m/s  
 Class II: Windspeed 2.1 - 4.0 m/s  
 Class III: Windspeed 4.1 - 6.0 m/s  
 Class IV: Windspeed > 6.0 m/s

*) Wind-direction	Classes				Total	Nobs	Average wind m/s
	I	II	III	IV			
30	1.6	0.9	0.3	0.1	2.9	( 63)	2.3
60	1.6	2.8	1.9	3.5	9.9	( 214)	5.5
90	0.7	1.8	1.5	6.1	10.1	( 218)	7.0
120	0.6	0.6	1.3	1.9	4.3	( 93)	5.4
150	0.7	0.6	0.4	0.2	1.9	( 40)	3.2
180	0.3	0.4	0.3	0.2	1.2	( 26)	4.0
210	0.8	0.5	0.7	0.3	2.3	( 49)	3.5
240	2.1	2.1	0.5	0.8	5.6	( 121)	3.3
270	6.8	5.2	4.2	15.8	31.9	( 689)	6.1
300	4.9	2.2	3.9	8.6	19.6	( 423)	5.6
330	1.7	0.8	1.1	2.4	6.0	( 129)	5.7
360	1.1	0.2	0.6	2.0	3.9	( 84)	6.7
Calm					0.4	( 9)	
Total	23.0	18.1	16.6	41.8	100.0	(2158)	
Average wind m/s	1.2	3.0	5.1	9.3			5.6

\*) This number indicates central direction of sector

Station : Hraun  
 Periode : SUMMER - 01.06.98 - 31.08.98

DIURNAL VARIATION OF WIND DIRECTIONS (%)

*) Wind-direction	Hours									Wind-rose
	01	04	07	10	13	16	19	22		
30	4.5	11.5	0.0	0.0	1.1	1.1	2.2	5.6	3.3	
60	18.0	14.9	17.6	7.6	18.5	23.9	31.5	31.1	21.3	
90	5.6	4.6	14.3	33.7	43.5	50.0	38.0	11.1	26.8	
120	1.1	3.4	7.7	5.4	4.3	5.4	6.5	3.3	4.6	
150	3.4	2.3	3.3	3.3	1.1	1.1	0.0	1.1	1.1	
180	0.0	1.1	2.2	2.2	0.0	0.0	0.0	0.0	0.8	
210	2.2	0.0	2.2	4.3	2.2	2.2	1.1	2.2	1.6	
240	10.1	6.9	11.0	12.0	5.4	4.3	3.3	6.7	7.7	
270	23.6	26.4	29.7	18.5	7.6	1.1	4.3	14.4	16.2	
300	11.2	12.6	6.6	8.7	8.7	8.7	7.6	8.9	8.8	
330	6.7	3.4	1.1	4.3	3.3	2.2	2.2	1.1	2.7	
360	2.2	3.4	0.0	0.0	2.2	0.0	1.1	4.4	1.6	
Stille	11.2	9.2	4.4	0.0	2.2	0.0	2.2	10.0	3.6	
N. obs	( 89)	( 87)	( 91)	( 92)	( 92)	( 92)	( 92)	( 90)	(2183)	
Average wind m/s	3.1	3.7	3.9	4.6	4.7	4.5	3.6	2.8	3.9	

DISTRIBUTION OF WINDSPEED WITH WIND DIRECTIONS (%)

Class I: Windspeed 0.4 - 2.0 m/s  
 Class II: Windspeed 2.1 - 4.0 m/s  
 Class III: Windspeed 4.1 - 6.0 m/s  
 Class IV: Windspeed > 6.0 m/s

*) Wind-direction	Classes				Total	Nobs	Average wind m/s
	I	II	III	IV			
30	2.6	0.5	0.2	0.0	3.3	( 71)	1.5
60	6.5	7.4	3.6	3.8	21.3	( 465)	3.6
90	6.7	11.5	6.6	2.0	26.8	( 584)	3.3
120	2.5	1.6	0.6	0.0	4.6	( 101)	2.2
150	0.7	0.3	0.1	0.0	1.1	( 24)	2.0
180	0.5	0.2	0.0	0.0	0.8	( 17)	1.6
210	0.9	0.5	0.2	0.0	1.6	( 35)	1.9
240	3.4	1.3	1.2	1.9	7.7	( 169)	3.7
270	1.7	2.3	3.4	8.7	16.2	( 353)	6.2
300	1.5	1.3	2.0	4.0	8.8	( 193)	6.4
330	0.7	1.0	0.8	0.2	2.7	( 59)	3.2
360	0.8	0.2	0.4	0.1	1.6	( 34)	2.7
Calm					3.6	( 78)	
Total	28.5	28.1	19.1	20.8	100.0	(2183)	
Average wind m/s	1.1	3.1	5.0	8.4			3.9

\*) This number indicates central direction of sector

Station : Hraun  
 Periode : GROWING SEASON - 01.05.98 - 31.10.98

DIURNAL VARIATION OF WIND DIRECTIONS (%)

*) Wind-direction	Hours									Wind-rose
	01	04	07	10	13	16	19	22		
30	4.5	8.4	0.0	1.1	1.1	1.1	2.2	4.9	2.9	
60	16.2	14.5	13.7	9.2	14.1	15.8	28.3	23.1	17.3	
90	5.6	6.7	15.8	26.6	35.9	41.3	27.7	8.8	21.4	
120	2.2	2.2	7.1	7.1	7.1	8.7	7.6	3.8	5.8	
150	2.2	1.1	2.7	2.2	0.5	2.7	0.0	1.1	1.6	
180	0.6	2.2	2.2	1.6	2.2	1.1	1.1	1.1	1.3	
210	1.7	1.1	2.2	3.3	2.2	1.6	1.6	2.2	1.9	
240	6.7	9.5	10.4	14.7	8.2	4.3	5.4	6.6	8.3	
270	26.8	32.4	29.0	20.1	12.5	8.7	9.2	21.4	19.7	
300	17.9	12.3	9.3	8.7	8.7	10.9	12.0	14.3	11.9	
330	5.6	2.8	2.7	4.3	3.3	2.7	2.2	2.7	3.2	
360	2.2	2.2	1.6	0.5	3.3	1.1	1.6	2.7	2.1	
Calm	7.8	4.5	3.3	0.5	1.1	0.0	1.1	7.1	2.6	
N. obs	( 179)	( 179)	( 183)	( 184)	( 184)	( 184)	( 184)	( 182)	(4387)	
Average wind m/s	3.6	3.9	4.2	4.6	5.0	4.8	4.1	3.6	4.2	

DISTRIBUTION OF WINDSPEED WITH WIND DIRECTIONS (%)

Class I: Windspeed 0.4 - 2.0 m/s  
 Class II: Windspeed 2.1 - 4.0 m/s  
 Class III: Windspeed 4.1 - 6.0 m/s  
 Class IV: Windspeed > 6.0 m/s

*) Wind-direction	Classes					Total	Nobs	Average wind m/s
	I	II	III	IV				
30	2.3	0.5	0.1	0.0	2.9	( 127)	1.5	
60	5.2	6.2	3.2	2.7	17.3	( 759)	3.5	
90	5.0	8.6	6.2	1.5	21.4	( 938)	3.4	
120	2.1	1.7	1.4	0.5	5.8	( 255)	3.2	
150	0.8	0.5	0.2	0.0	1.6	( 69)	2.2	
180	0.5	0.5	0.3	0.0	1.3	( 59)	2.9	
210	0.8	0.7	0.3	0.1	1.9	( 82)	2.5	
240	3.8	1.6	1.0	1.9	8.3	( 366)	3.5	
270	2.9	3.1	4.0	9.6	19.7	( 864)	6.0	
300	2.0	1.9	2.1	5.8	11.9	( 520)	7.1	
330	0.8	0.9	0.9	0.6	3.2	( 139)	3.9	
360	0.8	0.4	0.4	0.6	2.1	( 93)	4.3	
Calm					2.6	( 116)		
Total	27.1	26.6	20.1	23.6	100.0	(4387)		
Average wind m/s	1.2	3.0	5.0	8.9			4.2	

\*) This number indicates central direction of sector



# Norwegian Institute for Air Research (NILU)

P.O. Box 100, N-2007 Kjeller – Norway

REPORT SERIES SCIENTIFIC REPORT	REPORT NO. OR 40/99	ISBN 82-425-1099-7 ISSN 0807-7207	
DATE 179-98	SIGN. [Signature]	NO. OF PAGES 54	PRICE NOK 75,-
TITLE Update of model calculations for a planned aluminium smelter at Hraun, Iceland		PROJECT LEADER C. Guerreiro	
		NILU PROJECT NO. O-2008	
AUTHOR(S) C. Guerreiro		CLASSIFICATION * A	
		CONTRACT REF. Bernt Malme	
REPORT PREPARED FOR: Norsk Hydro A.S Technology & Projects Division Drammensvn. 264 Vækerø, Oslo			
ABSTRACT NILU has carried out a comparison of recent meteorological measurements at Hraun in Reydarfjörður with measurements at Mjöeyri in Eskifjörður, in the eastern part of Iceland and has updated the model calculations for a planned aluminium smelter at Hraun using the meteorological measurements at Hraun. Four alternatives for the smelter's production of aluminium were considered: 120,000 (ALT. 1), 240,000 (ALT. 2), 360,000 (ALT. 3) and 480,000 (ALT. 4) tons of aluminium per year. Long-term dispersion calculations were done for one year average SO <sub>2</sub> and PM10 concentrations and 6 months average gaseous and total fluorides, during the growing season. Dispersion calculations were also executed for a typical day with high impact of the pollution from the smelter on the population, for SO <sub>2</sub> and PM10, and on the vegetation, for gaseous fluorides.			
NORWEGIAN TITLE Oppdatering av spredningsberegninger for et planlagt aluminiumsverk på Hraun, Island.			
KEYWORDS Aluminium	Model calculations	Meteorology	
ABSTRACT (in Norwegian)			

\* Classification  
 A Unclassified (can be ordered from NILU)  
 B Restricted distribution  
 C Classified (not to be distributed)