

NILU : OR 37/94
REFERENCE : O-91023
DATE : JULY 1994
ISBN : 82-425-0586-1

The EUREKA project EU 615 EUROCORE WETCORR

Report from the NBS-MK seminar at
ABB Conference Centre, Billingstad,
24 November 1993

Jan F. Henriksen and Svein E. Haagenrud

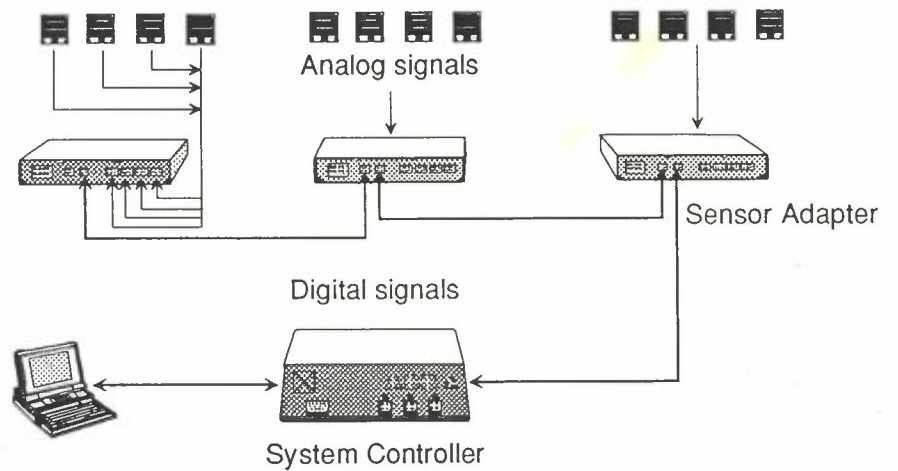

Contents

	Page
Summary	3
1. Introduction	5
2. Aims of the seminar	5
3. Programme for the seminar	6
4. The WETCORR instrument – Concept and characteristics	7
4.1. Scientific background – critical humidity for deterioration.....	7
4.2. The critical humidity level measurements	8
4.3. The WETCORR instrument	11
4.4. Presentation of results	12
4.5. Interpretation of data for the wet/dry Au sensor	12
4.5.1. Sensors freely exposed	12
4.5.2. Sensors in sheltered position.....	14
4.6. Service life of a sensor	14
4.7. Application of the WETCORR instrument in environmental studies.....	14
4.8. The attachment of the sensors to different surfaces.....	15
5. Calibration test	15
6. Data presentation.....	16
7. ABB sales offer.....	16
8. Conclusions from tests with ten WETCORR instruments	17
8.1. WETCORR monitoring at the Royal Palace of Stockholm (P. Norberg - Swedish Institute for Building Research, Gävle).....	17
8.2. WETCORR monitoring at Nidaros Cathedral, Trondheim (J.F. Henriksen and M. Støre - Norwegian Institute for Air Research, Lillestrøm)	17
8.3. WETCORR instrument used in the UN/ECE-ICP project (B. Rendahl and V. Kucera - Swedish Corrosion Institute, Stockholm)	18
8.4. Use of WETCORR instrument on an artificial facade (P.F. O'Brien and T.P. Cooper - Trinity College, Dublin, Ireland)....	18
8.5. Use of WETCORR instrument at NILU's laboratory (J.F. Henriksen and M. Støre, Norwegian Institute for Air Research, Lillestrøm).....	19
8.6. Monitoring of time of wetness on concrete slabs (Ernst J. de Place - Danish Building Research Institute (SBI), Hørsholm)	20
8.7. The usage of the WETCORR instrument in Iceland (Björn Marteinsson - Icelandic Building Research Institute, Reykjavik)	21
8.8. Laboratory and field test at SIB (Peter Norberg - Swedish Institute for Building Research, Gävle)	22
8.9. Wetness impact around windows (Bengt Svennerstedt - Svennerstedt Consulting, Lund, Sweden)	24
9. References	24

	Page
Appendix A: Characteristics of the WETCORR instrument.....	27
Appendix B: Results from the calibration tests	33
Appendix C: Data presentation package.....	41
Appendix D: ABB sales offer	47
Appendix E: WETCORR monitoring at the Royal Palace of Stockholm.....	51
Appendix F: WETCORR monitoring at Nidaros Cathedral, Trondheim.....	63
Appendix G: WETCORR instrument used in the UN/ECE-ICP project.....	71
Appendix H: Use of WETCORR instrument on an artificial facade.....	81
Appendix I: Use of WETCORR instrument at NILU's laboratory	89
Appendix J: Monitoring of time of wetness on concrete slabs	99
Appendix K: The usage of the WETCORR instrument in Iceland.....	111
Appendix L: Laboratory and field test at SIB.....	117
Appendix M: Wetness impact around windows	133

Summary

Within the EUREKA project EU 615 EUROCARE WETCORR a 0-series of 10 instruments of an industrialized version of the NILU WETCORR instrument for measuring the real time of wetness has been developed in co-operation between Norwegian Institute for Air Research (NILU), ABB Energy (ABB), the Swedish Institute for Building Research (SIB) and the Swedish Corrosion Institute (KI). The WETCORR instruments have been tested out for 1-2 years by several specialists in Nordic and European R&D projects.

The results from the projects were presented at a seminar at ABB Conference Centre, Billingstad, 24 November 1993. The report gives a description of the theoretical background for the instruments together with the main conclusion for the tests carried out.

The main conclusions from the tests were that the instruments followed the specifications given. In a few tests some intermittent failures were observed in the data recordings.

It was further defined a need for improvements of the current and temperature sensors used and in the software package for the data handling.

The EUREKA project EU 615 EURO CARE WETCORR

**Report from the NBS-MK seminar at ABB Conference Centre,
Billingstad, 24 November 1993**

1. Introduction

The EUREKA project EU 614 EURO CARE WETCORR was established in 1991 as a co-operation project between the Norwegian Institute for Air Research (NILU), ABB Energy (ABB), the Swedish Corrosion Institute (KI) and the Swedish Institute for Building Research (SIB). NILU had at that time developed a WETCORR instrument for monitoring the real time of wetness in the micro-climate of a structure or a building and used it in research projects for many years. The aim of the EUREKA project was then to further develop and industrialize the WETCORR instrument. The first ten WETCORR instruments were ready for quality testing in various applications in 1992. These tests have been performed in research projects at different Nordic and European research institutions.

A first project seminar in Scandinavian language was arranged in Stockholm 28 April 1993. The conclusions from that seminar were promising. The quality and performance of the instrument was good. However, the interpretation of the signals into wetness parameters could sometimes be difficult. One problem was that the tests made did not include a joint calibration test of sensors and instruments. The statistical treatment of the results could therefore be complicated. It was agreed that a calibration test should start, and that a longer test period was needed to get the final conclusions.

2. Aims of the seminar

- Presentation of the WETCORR instrument – concept and characteristics of instrument and sensors.
 - Presentation of the results from various monitoring applications as performed in the test programme.
 - Summarize the knowledge obtained, define weaknesses and possible improvements.
 - Presentation of sales offer of WETCORR.
-

3. Programme for the seminar

The WETCORR instrument for monitoring of time of wetness (TOW) and temperature.

Time: 24 November 1993 at 0900 -1600

Place: ABB Conference Centre Audition, Bergerveien 12, Billingstad (Oslo), Norway

The EUREKA project EU 615 EUROCARE WETCORR aims at an industrialization of the WETCORR instrument for monitoring of time of wetness and temperature. In this respect quality testing and various monitoring applications have been performed at Nordic and European research institutions.

Aims of seminar:

- * *Presentation of the WETCORR instrument - concept and characteristics of instrument and sensors*
- * *Presentation of results from various monitoring applications as performed in test programmes*
- * *Presentation of sales offer of WETCORR*

0830-0900	<i>Coffee and registration</i>	
0900-0915	<i>Welcome and introduction</i>	<i>S. Haagenrud, NILU</i>
0915-1000	<i>Presentation of WETCORR - concept and characteristics of instrument and sensors, calibration tests, data presentation package</i>	<i>J.F. Henriksen, NILU T. Krognes, NILU</i>
	• Discussion	
1000-1045	<i>ABB sales offer</i>	<i>G. Vollebæk, ABB</i>
	• Product, delivery, price, service	
	• Discussion	
1045-1100	<i>Coffee break</i>	
1100-1145	<i>WETCORR monitoring on historic buildings</i>	
	• Royal Palace of Stockholm	<i>P. Norberg, SIB</i>
	• Nidaros Cathedral	<i>J.F. Henriksen, NILU</i>
	• Discussions	
1145-1245	<i>Lunch</i>	
<hr/>		
1245-1315	<i>Demonstration of WETCORR and monitoring applications</i>	
1315-1415	<i>Experience from Laboratory and field tests</i>	
	• On UN/ECE ICP test sites	<i>V. Kucera, KI</i>
	• At Trinity College	<i>P.F. O'Brien, TC</i>
	• At NILU's roof laboratory	<i>J.F. Henriksen, NILU</i>

1415-1430 *Coffee break*

- | | | |
|-----------|---|--|
| 1430-1530 | <ul style="list-style-type: none"> • Monitoring on concrete panels • Effect of slashing rain • Laboratory and field tests at SIB • Wetness impact around windows • Discussions | <p><i>E. de Place, SBI</i>
 <i>B. Marteinson, Rb</i>
 <i>P. Norberg, SIB</i>
 <i>B. Svennerstedt, SC</i></p> |
|-----------|---|--|

1530-1600 *Concluding discussion*

<i>NILU</i>	=	<i>Norwegian Institute for Air Research</i>
<i>ABB</i>	=	<i>ABB Energy</i>
<i>SIB</i>	=	<i>Swedish Institute for Building Research</i>
<i>KI</i>	=	<i>Swedish Corrosion Institute</i>
<i>TC</i>	=	<i>Trinity College</i>
<i>SBI</i>	=	<i>Danish Building Research Institute</i>
<i>SC</i>	=	<i>Svennerstedt Consulting</i>
<i>Rb</i>	=	<i>Icelandic Building Research Institute</i>

4. The WETCORR instrument – Concept and characteristics

4.1. Scientific background – critical humidity for deterioration

Material deterioration is caused by chemical reactions where moisture very often plays an important role. The chemical reactions will accelerate with increasing humidity, and for most materials a critical humidity (CH) level can be defined where above the deterioration will be substantial. Generally, the time when the material is exposed to conditions above this critical level is defined as "the time of critical humidity" (TOCH).

The understanding of the processes is best known for metals, but the humidity impact is also observed for materials like wood, stone, rendering and concrete.

For metals the corrosion is caused by electrochemical reactions on the surface and the formation of an electrolyte is essential. The formation of the electrolyte depends on humidity and the pollutants available, as illustrated in Figure 1 for carbon steel. In extreme clean laboratory conditions, 100% relative humidity (RH) and dew are needed to start the corrosion. In practice the electrolyte will be formed at lower RH due to pollutants. In areas where gas pollutants like SO₂ are present, a critical humidity level of 80% for corrosion is observed, and in areas with sea-salt aerosols the critical humidity level will be even lower. From these relationships the well-known term Time of Wetness (TOW) has been generated as the time when humidity is above a critical level where metal corrosion is substantial.

From empiric observations, the term TOW for metals is defined as the time when the relative humidity is greater than 80% at temperature above 0°C. This definition is used in ISO standard 9223 "Corrosion of metals and alloys - corrosivity of atmosphere - classification".

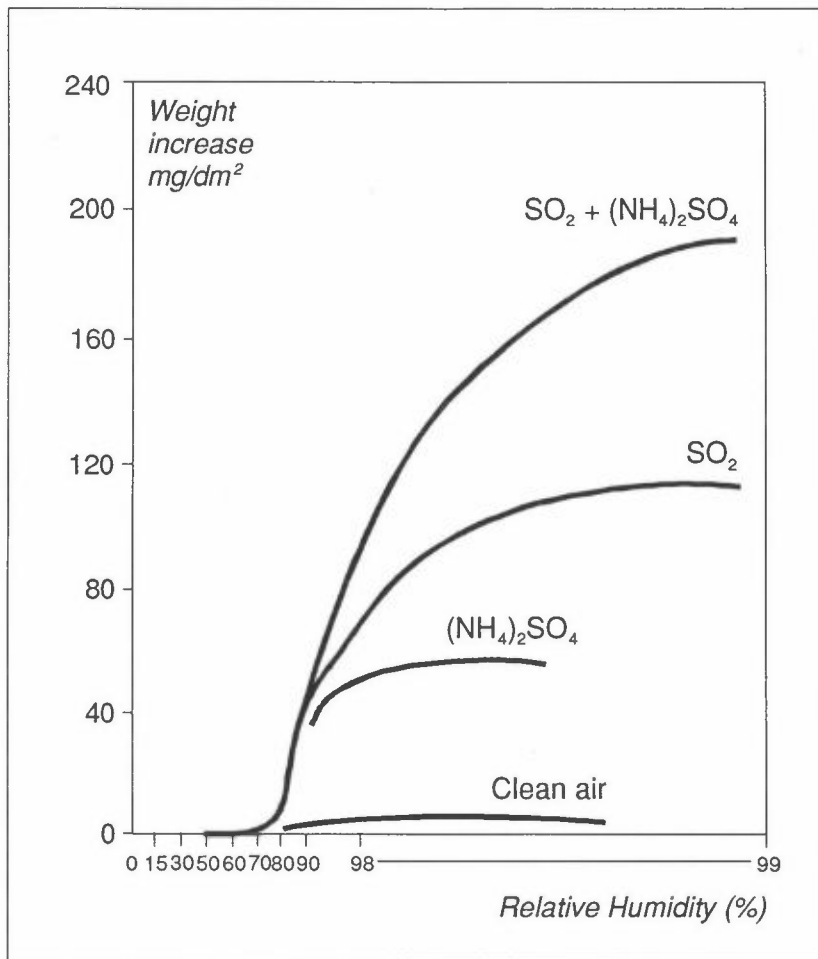

Figure 1: Corrosion attack on carbon steel at increasing relative humidity, based on work by W.H. Vernon (Bardal, 1985).

In the actual micro environment for constructions deviations from this simple correlation will occur. The critical humidity level is dependent on the materials and the pollutants present. For steel corrosion is proved to take place even at temperatures down to -4°C . Consequently there is a great need for developing monitoring methods for mapping the critical humidity conditions and the time above these levels (TOCH) in the micro environment for the various constructions and materials in use.

4.2. The critical humidity level measurements

The WETCORR instrument is designed for recording of the humidity and temperature condition in the micro environment of constructions.

The measuring principle makes use of the electrochemical nature of the corrosion processes by measuring the current flow in an electrochemical cell as a function of the humidity film on the electrode surface. The principle was proposed by Professor Thomashov as early as in 1950ies and has later been adapted and modified by other groups such as The National Research Council of Canada, The Swedish Corrosion Institute, The Norwegian Institute for Air Research, and The

Swedish Institute for Building Research (see the reference list). In Figure 2 the simple measuring circuit used is illustrated. The wetness sensor is connected to a constant voltage power supply (P) and the current flow through the system is measured with a zero-resistant amperemeter.

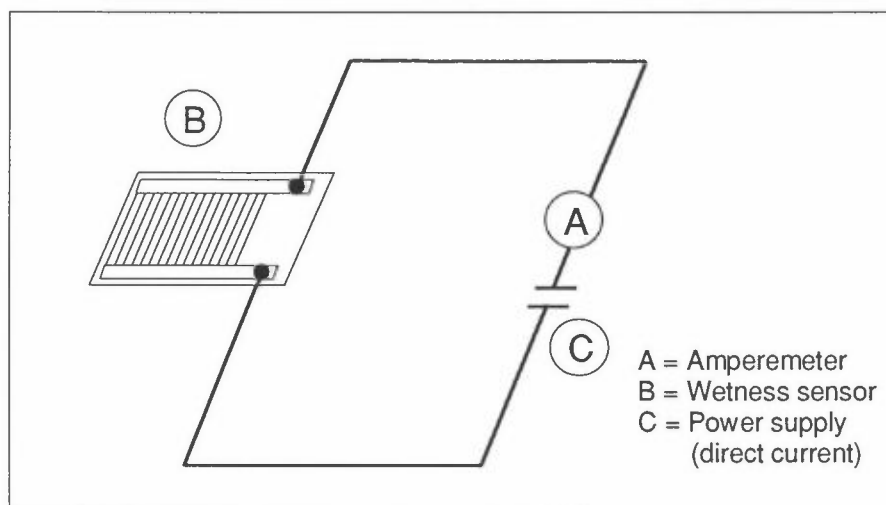

Figure 2: A schematic layout of the measuring circuit.

Based on the electrochemical reactions which take place on the surface of the cell, the theoretical correlation between the current flow and the electrolyte thickness can be calculated. A theoretical study in the 1980ies showed that an electrochemical cell will have a log-log relationship between the current flow and the electrolyte thickness up to a thickness of approximately 10 μm and little increase at even thicker layers. The basic results of the theoretical studies in the 1980ies are expressed in Figure 3 for *one selected* cell geometry. Parameters which will effect the current output are the design of the cell, the conductivity of the electrolyte and the material used in the cell.

In the instrument development phase the sensor used consists of a small gold cell for wetness measurements and a temperature sensor for recording the surface temperature.

To ensure that the temperature sensor follows the surface temperature, the cell backing is made of aluminium oxide with good thermal conductivity.

The gold wetness sensor is made of two gold electrodes arranged in a finger pattern. A fixed voltage usually selected in the range between 100 mV and 200 mV is applied and the current flow is measured. To prevent polarization of the electrodes the direction of the voltage is changed every 30 sec.

The current output for the gold sensors used in the development phase, is shown in Figure 3. The detection limit for the instrument was 1 nanoampere (nA) and this limit corresponds to a relative humidity in the air close to 100% RH, marked in the figure as RH_{lim1} . When standard deviations in the current output from the

different sensors are accounted for, the sensors used in the development phase will act as a *wet-dry sensor* where dew or rain is needed to get sufficient response from the sensor.

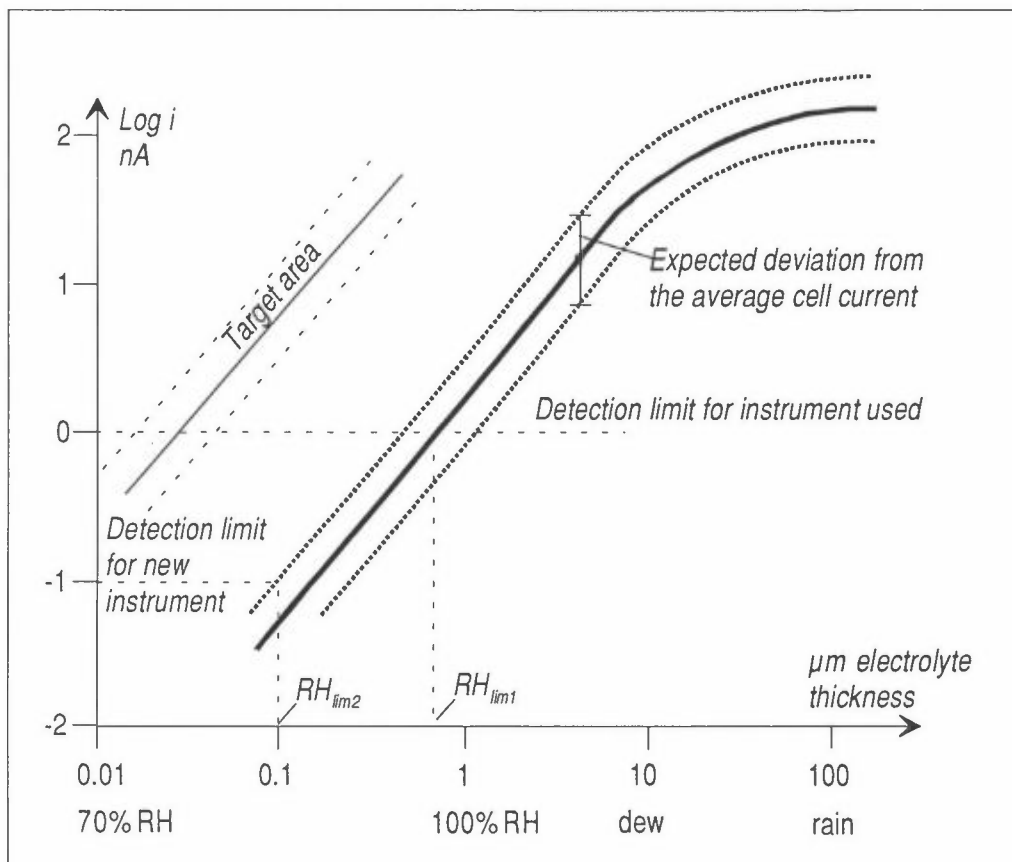

Figure 3: Calculated current output for different electrolyte thickness on Au wetness sensor and the target area for a new generation of sensors.

Two measures are undertaken to increase the sensibility and thereby enabling determination of critical humidity in a broader relative humidity regime.

Firstly, the instrument detection limit is lowered to 0.1 nA (see Figure 3). This is now electronically feasible, and the new adapters for sale will be delivered with these characteristics. Corresponding limiting relative humidity is RH_{lim2} and close to 80%.

Secondly, emphasis is now on developing more sensitive sensors. The system will be delivered with the Au sensors, but we aim at delivering various types of well characterized humidity sensors. Promising results with Cu sensors, painted sensors and other types have already been obtained.

In outdoor application pollutants will be attached to the sensor and the current response will increase due to increased conductivity, and because the pollutants normally are hygroscopic and therefore absorb and build up the electrolyte thickness needed at lower relative humidity.

The surface condition of the sensor will therefore change with time in the same way as the condition of the construction surface itself. A freely exposed sensor in fairly clean areas will keep a current response similar to the curve in Figure 3 for a long time, while in more polluted areas and in sheltered positions the current output will increase.

4.3. The WETCORR instrument

The principle for the WETCORR instrument is shown in Figure 4.

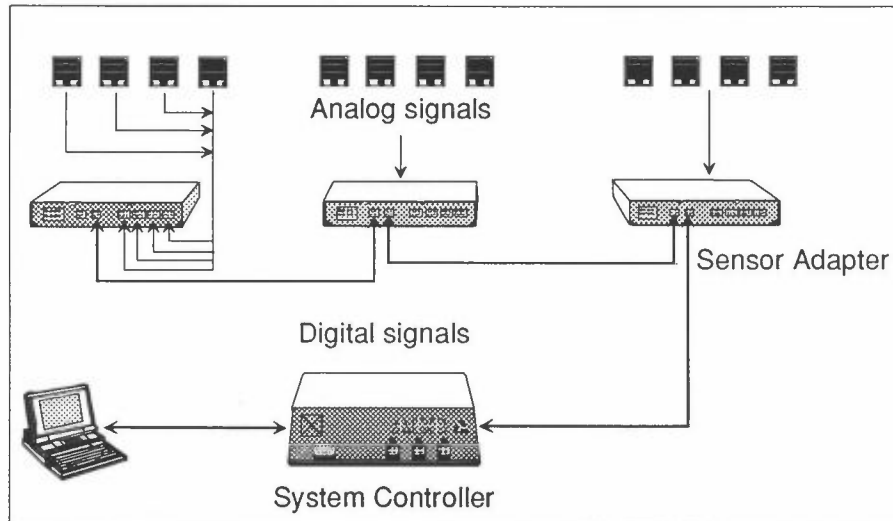

Figure 4: The principle for the WETCORR instrument.

The instrument consists of the following modules

- 1 System Controller (SC)
- 1-16 Sensor Adapters (SA)
- 1-64 Sensors

The technical specification is given in the attached technical data sheets.

The System Controller is the control unit for communication with the Sensor Adapters, and is also the unit for the external communication with a PC directly or through a modem. The SC is also the power source for the sensors and SA, and sampling unit for all measuring data.

The Sensor Adapter is the control and recording unit for four sensors. The data are recorded as average values over one minute. The SA will convert all data recorded to digital signals before transferring the data to the System Controller. This is done to reduce the influence of stray currents and radio signals on the measured data. Therefore the sensor cables are kept short, 2 metres, while the cables for the digital signals can be long, up to 250 metres in two directions. The Sensor Adapter can be placed outdoors in rain and wind.

The parameter set-up for one adapter is valid for all the sensors connected to this adapter, while each adapter in a system can be configured individually. The parameters are cell voltage and sampling period.

4.4. Presentation of results

The instrument is delivered with one software programme for communication, parameter setting and recording of data. The amount of data has always been a problem in this type of measurements, and great emphasis is put on solving this problem through user-friendly database design and management, and data presentation tools.

The instrument will therefore be supplied with Windows based software package for presentation of the data, using Microsoft Access version 1.1 and Visual Basic Pro 3.0. Presentations within geographical information systems (GIS) will also be available shortly.

The following presentation forms will be available:

- Plots of currents versus time and temperatures versus time
- Total current output from the cells in the period
- % time with current above the selected critical humidity levels (TOCH)
- % time with the temperature above or below selected temperatures
- Frequencies for TOCH and temperature above selected values
- Min., Max. and Mean values for current and temperature
- Min., Max. and Mean values for the time with TOCH.

4.5. Interpretation of data for the wet/dry Au sensor

The interpretation of the current reading *will depend on the pollution level* in the micro environment where the sensor is applied.

4.5.1. Sensors freely exposed

The current is expected to change about two decades from complete dry to soaking wet. In polluted area and in the coastal zone the *wet* current may be substantial, but in background areas less than 100 nA. For calculation of the time of critical humidity (TOCH), in this case real time of wetness, a corresponding current threshold must be selected. The threshold value must be selected below the normal variation of the current observed during rain periods. As a code of practice for the gold sensors, the following equation can be used to define the threshold current for the critical humidity level (i_{thres})

$$\log i_{thres} = \log i_{min.} + \frac{\log i_{max.} - \log i_{min.}}{2} = \frac{\log i_{max.} + \log i_{min.}}{2}$$

An illustration of the way to calculate the threshold current is given in Figure 5A.

Interpretation of the threshold value will depend on the environmental condition and the material in use.

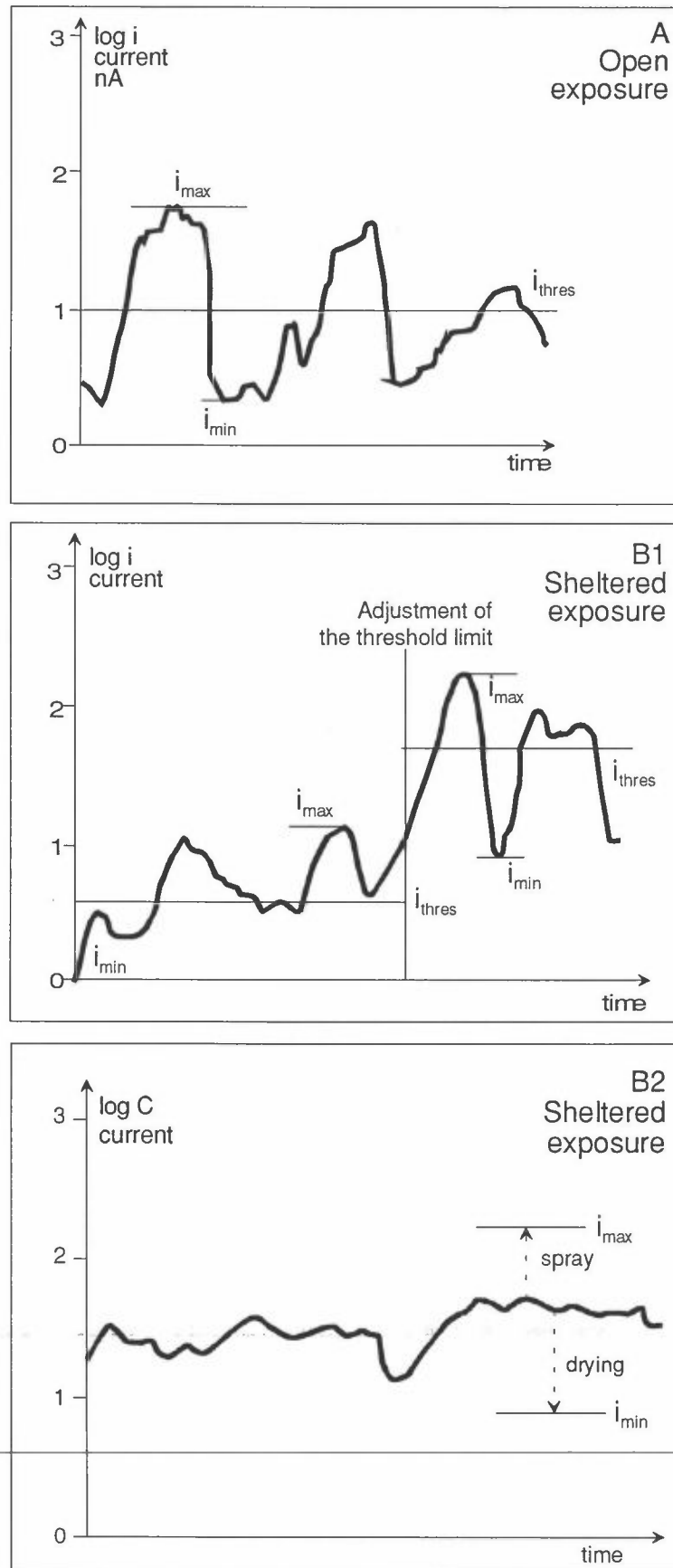

Figure 5: Illustration of the way to calculate the threshold sensor current in open position A and sheltered position B1 and B2.

4.5.2. Sensors in sheltered position

The current observed on a sheltered sensor will change with time. In the beginning when the sensor is clean very little happens. With time the response of the sensor will increase. The baseline will reach values above 1 nA and the time with moisture on the sensor will increase due to pollution deposits (see Figures 5B1 and 5B2). In the end the current levels can be higher than on freely exposed sensors and the TOCH will also exceed the results of the freely exposed sensor. In areas with high amount of hygroscopic salts and high humidity, as in coastal areas, the sensor will hardly ever be dry, except for sensors which can be heated by the sun radiation.

If the sensors have current fluctuation of the same magnitude as for freely exposed sensors, the same method for calculation of TOCH can be used for shorter periods. Adjustments of the threshold level must be carried out with the time because of the change of the baseline (see Figure 5B1).

For sensors with more or less the same current the whole time, the wet and dry current of the sensor must be defined. The dry current can be defined by drying the surface artificially with an IR-lamp. If the current seems to be low, the wet current can be established by light spraying of water on the surface (Figure 5B2).

4.6. Service life of a sensor

The wetness and temperature sensors are quite durable and may have long lasting lifetime. The experience with the temperature sensor is that mechanical breakdown of the connecting legs is the most dominating failure. The output signal will then be constant -38.4°C . With badly insulated legs leakage current between the legs will break the legs after a short time.

Mechanical damage of the gold wetness sensor can make a short circuit of the cell and create a very large current through the electric circuit. The pollutant layers formed on the sensor may cause the same reaction. Under open exposure this may happen by soot or salt particles bridging the electrodes. Cleaning of the sensor may help. However, in environments with soot and salt particles reduced service life for sensors can be expected. The situation in sheltered position has many of the same aspects as the bridge in open positions. However, if the exposure situation for the sensor and the material is the same, the goal of the project is decisive for whether the sensor signal still has relevance or if the sensor needs to be replaced.

4.7. Application of the WETCORR instrument in environmental studies

Through the last year's testing of the WETCORR instrument, several interesting applications have been accomplished. The applications can be divided in the following groups:

- mapping of the wetness impact on different sides and parts of buildings (Royal Palace – Stockholm, Nidaros Cathedral – Trondheim)
- wetness studies on panels and artificial facade details
- wetness studies on building parts (windows).

Earlier, interesting tests have been carried out with painted sensors and with sensors applied inside materials like chipboard.

For further information, see the Appendices.

4.8. The attachment of the sensors to different surfaces

The attachment of the sensor to the selected surfaces by double sticking thin tape is easy on a smooth, clean surface like a facade sheet. Problems may occur on these surfaces if they are dirty, and cleaning may be necessary.

On rough facades, such as old stone wall, double sticking tape directly applied will not work and we need to use thicker glue with curing time. One way to solve the problem is to apply small metal sheets like aluminium on the stone by use of silicone glue and let it cure before the sensor is applied on metal sheet by use of the double sticking tape.

5. Calibration test

At the previous WETCORR seminar in Stockholm 28 April 1993, it was decided to make a standardized calibration test for the use of the WETCORR instrument. The main purpose for the calibration test was to define the spread in the temperature and the time of wetness results for sensors which was exposed under the same condition. The calibration test had the following steps:

1. 8 cells were attached to the same material and mounted to a rack facing south at a 45° angle. The exposure period should be about 2 months.
2. The same 8 cells should be exposed in a climate chamber for one week at different relative humidities. At the end an artificial rain shower was introduced.

Step 1 of the test was carried out at the Norwegian Institute for Building Research (NBI), Trondheim, SBI and NILU. Similar tests had earlier been carried out at SIB and KI. Step 2 of the test was carried out at SBI and NILU.

The main conclusions from the results listed in Appendix B were:

- The cell current response was comparable and the current pattern was identical. The spread was within a range of 10-30%. At some test sites the sensor response was at two different levels even if the current pattern was comparable.
- The spread in the temperature sensors used was higher than expected, and not sufficiently accurate for the use planned.
- Out of 40 adapters tested one sensor had a poor connection.
- For some of the adapters an intermittent failure without data recorded were observed.
- In the climate chamber the gold sensors had no response before the rain was introduced.

The following suggestions for improvements and better use of the sensors were made:

The temperature sensor:

- One point calibration of the temperature sensor is insufficient and two point calibration or the use of better quality sensors could improve the accuracy needed.

The current sensor:

- The spread in the results is acceptable since the current pattern is identical. However, if the threshold current takes into account that the levels for two sensors could be different, the spread could be reduced (see 4.5.1).
- The current output from the gold cells was low and efforts to increase the output and the sensitivity at lower relative humidities should be carried out.

6. Data presentation

The data presentation package used in the test period seems to be laborious and more statistical treatment of the data is needed.

The presentation forms listed in Chapter 4.4 was presented together with a plan to use a Window based system in Visual Basic for all communication with the instrument and for data handling and presentation (Appendix C).

No objections to the ideas were raised, but several proposals for improvements were put forward.

7. ABB sales offer

The detailed situation is shown in Appendix D.

ABB Energy is a subsidiary company of the ABB industry concern, and has a group with special systems for environmental information:

Envi-Save	Waste Water Control System
Aqua-Safe	Pure Water Control
CRM	Continuous River Monitoring System
Mini SCADA	Supervision Control System
WETCORR	Environmental Impact Measuring

ABB Energy is pleased with the interest shown for the WETCORR instrument, but they need more specific orders before they can start a new production. An estimated production time for the instrument series will be approximately 4 months. ABB's estimated of the total price is NOK 51,700.-. This price includes one system controller, four sensor adapters, software package, and 16 sensors. For

the future support they propose to establish a WETCORR user group to get support for further development of the system, its software and its use.

8. Conclusions from tests with ten WETCORR instruments

8.1. WETCORR monitoring at the Royal Palace of Stockholm (P. Norberg - Swedish Institute for Building Research, Gävle)

The study is described in Appendix E and the main conclusions were:

The measurements of surface moisture and TOW using the WETCORR method show results that are, in principle, consistent with the anticipated moisture situation at the Royal Palace. In sheltered positions, however, effects of pollution deposition can be observed in the recorded current. The reason for this is probably contamination of air pollutants or possibly dust from the restoration work currently being performed at the Royal Palace. Whatever source, the contaminants contribute to an increased electric conductivity of the moisture film adsorbed on the sensor grid. Owing to its sheltered position, there will be no natural rinsing or cleaning of the sensor, as is the case, more or less, at the unsheltered positions.

The different positions at the Royal Palace show that, on an average, the longest TOW is about 2-3 times longer than the shortest TOW.

During cold periods, there is only a fair agreement between TOW measured by WETCORR and that estimated from ISO 9223. This seems mainly be due to the fact that ISO 9223 only considers temperatures above 0 °C.

8.2. WETCORR monitoring at Nidaros Cathedral, Trondheim (J.F. Henriksen and M. Støre - Norwegian Institute for Air Research, Lillestrøm)

The study is described in Appendix F and the main conclusions were that the environmental impact is quite different on the different sides of the cathedral. The oldest part, which is facing east, is hardly ever reached by rain at all. However, dry deposition of particle and the deterioration products formed will absorb water and create a surface layer able to continue the deterioration processes.

The new highly decorated west facade is effected by slashing rain and the ornaments create a surface with local large differences in the time of wetness. The sheltered parts of the facade has a situation similar to the east facade.

The attachment of the cells to the rough surface was complicated and could be solved in the same way as described in Chapter 4.7.

8.3. WETCORR instrument used in the UN/ECE-ICP project (B. Rendahl and V. Kucera - Swedish Corrosion Institute, Stockholm)

The study is described in Appendix G and the preliminary conclusions were:

The reproducibility between cells exposed in parallel has been very good at free exposure, while at sheltered exposure the spread in results is greater. It should, however, be stressed that this may be due to a non uniform deposition of pollutants on the cell surface which is not equalized by precipitation as is the case at free exposure.

The value of the wetness threshold level is of principal interest and will affect the time of wetness measured by the technique. At open exposure there is only a small difference between the 10 and 20 nA levels, while at the 100 nA level the time of wetness was much shorter. The wetness measured and calculated according to ISO (time with RH > 80% and T > 0 °C) shows the same pattern as the WETCORR values, but the ISO values are usually higher even than at the 10 nA level.

The length of the exposure period for standardized measurements is so far not easy to recommend. At free exposure no visible signs of deterioration were observed. At sheltered exposure, however, the current level and thus the time of wetness gradually increases which is obviously connected to deposition of pollutants at the cell surface.

The frequency of measurements has been 15 minutes which gives a great amount of data. It should be of interest to compare the so achieved values of time of wetness with values obtained from less frequent measurements.

The measurement of temperature seems to give very reproducible values. They show i.e. that the shelter strongly suppresses the temperature variations compared to open exposure.

8.4. Use of WETCORR instrument on an artificial facade (P.F. O'Brien and T.P. Cooper - Trinity College, Dublin, Ireland)

The study is described in Appendix H and the main conclusions drawn were:

The data set from the WETCORR instrument analysed agrees well with the expected moisture regime from the different micro environments. Micro environment 1 is the most exposed. The closeness of the projection has a pronounced effect on the bottom of this micro environment as measured by cell 2. A similar effect may explain the high current levels in cell 5 at the bottom of micro environment 3. ~~The effect of increased salt loading on sensors lower down could also produce higher currents.~~ The effect of salt loading on the magnitude of current has been demonstrated [1]. Runoff from above could deposit extra salt on sensors lower down.

The effect of orientation on time of wetness was very pronounced. The effect of the canopy on the micro environment was demonstrated by the data from cells 3

and 6. As well as a much lower overall current level underneath (80 versus 200 nA) the fluctuations in response to environmental conditions were very much greater. The diurnal trends in current closely follow expected relative humidity cycles. Increased relative humidity at night when temperatures are low with lower relative humidity during the day when temperatures are higher.

The cells attached to the different micro environments will develop a layer of salts which reflect the conditions where it is exposed. The cell current will respond to changes in the moisture regime of this surface layer. Thus the sensors should respond in a similar fashion to the stone surface layer. To the extent that the cell surface mimics the stone surface it will give an accurate representation of the surface moisture conditions. The work presented here demonstrates the ability of the device to detect differences in micro environmental conditions over small areas. Given that the moisture regime is an important determinant of the rate and mechanism of stone decay the WETCORR device should prove useful. It is being used on an ongoing basis in the research programme at TCD. Further work needs to address how closely the cell surface layer mimics the stone surface environment.

8.5. Use of WETCORR instrument at NILU's laboratory (J.F. Henriksen and M. Støre, Norwegian Institute for Air Research, Lillestrøm)

The main aims of the tests carried out at NILU's laboratory were to illustrate different ideas about the use of the WETCORR instrument and the interpretation and the statistical treatment of the data collected (Appendix I). The following results and conclusions are summarized:

- Sensors exposed in a complete rain-sheltered position on a coil coated steel facade have a much higher "time of wetness" than sensors freely exposed on the same wall.
 - The time of wetness recorded locally by a sensor differs from the calculated time of wetness from temperature and relative humidity data. This shows the need for a sensor for exact measurements in the micro environment.
 - There is a minor difference between the time of wetness values calculated using different threshold currents as long as the values are close to the threshold current defined in the equation in Chapter 4.5.1.
 - Several tests both at NILU and at Nidaros Cathedral have shown that increased current output is observed on sensors when the temperature drops below 0 °C. However, a complete interpretation of the results is still missing.
-
- Tests with the sensors applied into a wood panel structure show that the water capillary force is higher in the crevice between the panels than the capillary forces acting inside a panel.
 - The small building on NILU's roof is constructed with hardly no shelter for the facades. Even so the impact of rain is only observed on two sides for the vertical facade of the building.

8.6. Monitoring of time of wetness on concrete slabs (Ernst J. de Place - Danish Building Research Institute (SBI), Hørsholm)

The study is described in Appendix J and the main conclusions were:

The reproducibility of the sensors seems OK, although they do not seem to respond at exactly the same time and do not reach quite the same level when wet. During wet periods the maximum response can go as high as 600-800 nA (in the summer somewhat lower). The ultimate high response measured is 11 317 nA in March 1993, half an hour later the same sensor showed 64 nA. The sensors show a minimum response of about 15-20 nA, also during long dry periods, a little lower in summer than in winter. There seems to be a reasonable correspondence between the TOW, and a combination of the RH, the amount of sunshine and the temperature. However, the results indicate that a rainy month (July 1993 gave 110 mm) does not necessarily give a high TOW, and vice versa a dry month (February 1993 gave 29 mm) might give a high TOW. See also table 1.

The outdoor exposure showed good correlation between the new sensors (used in the calibration test) and the sensors placed in November 1992. Only the first 4 days gave very low response (3-5 nA) in the new sensors. In the climate chamber, however, the response of the sensors was almost unaffected by the changes in RH used for this test. Only when spraying with artificially made rainwater a clear response is seen.

No difference in temperature was measured between the sensors fastened to the aluminium plate and the sensors fastened to the concrete slabs. In contrast to the major part of measurements the sensors fastened to the concrete slabs are oriented in such a way that it is possible for water to run along the wire and down to the sensor (see Figure 2). This was done to avoid problems with water inside the wire. In the calibration test the sensors were oriented with the wire downwards. There does not seem to be any dependency of this difference in orientation, as the sensors fastened to the slabs and to the aluminium plate responded quite similarly during the summer, when the calibration test took place.

We do not have experience with the behaviour of the sensors during periods with frost and/or snow.

The sensors on the slabs do not show any sign of deterioration after an exposure of one year.

We have some proposals for improving the reliability of the sensors. It is assumed that each WETCORR sensor can be described as a discrete component which only has electrical connection to the sensor adapter. However, it is shown that the WETCORR sensor sometimes has electrical connection to the temperature sensor. At high RH a leakage to the surroundings will exist. By changing the pattern of the electrodes on the WETCORR sensor these problems should be minimized (see Figure 3). In order to improve the reliability of the temperature measurements we suggest to use a gold resistor applied in the same way as the pattern of the WETCORR sensor (see Figure 3) and protected with a moisture-proof layer. The temperature sensor should be placed outside the "guard" of the WETCORR sensor as

shown on Figure 3. Considering all the possible sources of error when measuring temperature a 1-point calibration of the temperature sensor seems adequate. To minimize electrical interaction between the WETCORR sensors the excitation to the sensors should be pulsed instead of continuous. The mounting of the sensors to be construction should be better specified.

The controller and the adapters have performed without any problems. In October 1993 the power supply unit to the system controller was attacked by mice and was replaced. Nevertheless, the system controller still held data for 2 weeks of the period since the latest unstore (data are unstored once a month).

An updated version of the software was received in April 1993. After installation and necessary adjustments the software has been running without any problems. The automated processing of data and printout is working but has not been used. It would be an advantage if during the automated processing of data it was possible to examine the data in more detail and possible to see a graph and adjust the thresholds before printing it out.

It is proposed to supplement the statistic module with a feature to determine the frequency of TOW and the longest period above a specified threshold.

As mentioned the purpose of the outdoor exposure in this project is to determine the moisture characteristics, primarily the moisture content. The WETCORR measurements can be used for this by selecting suitable thresholds defining wet cells and take into regard the fact that it takes some time for a moisture-film to build up and break down respectively on the surface of a porous material such as concrete. Based on field tests on concrete facades facing north and east respectively, Svennerstedt concluded that the TOW will not change noticeably when these facts were taken into account.

To calculate the moisture content the results must be combined e.g. with determination of diffusion coefficients and a pore size distribution and a mathematical model for correlating the amount of surface moisture and the moisture content in the material must be developed. This illustrates that there still is some work to be done before we can determine the moisture content in porous materials by means of WETCORR measurements.

8.7. The usage of the WETCORR instrument in Iceland (Björn Marteinsson - Icelandic Building Research Institute, Reykjavik)

The test in Iceland was mainly carried out to study the effect of driving rain and has so far given the following main results (Appendix K):

-
- The instrument is in itself very stable in use and has a good handling characteristics.

The following requirements for improvements are listed:

Collection of information of a general character from laboratory - user to ease the decision making about data collection and transport to a computer. To name a

few examples; convenient measurement rate (the amount of data grows to some huge data files!), recommended voltage on sensors (to ease later comparison between laboratories), to notify the user of different end-of-line in DOS and the Macintosh (the return/linefeed characters are used in different order to signify a new block of data).

- The software is written to extract TOW for a sensor for any given length of time, but the software and the handbook need some (considerable) time to be understood!

Requirements:

A more flexible software to evaluate the considerable amount of data collected, and to compare data between sensors in an easier way.

- Irregularities in the current of the distribution net result in an very localised scramble of the data file, but these make the files hard to process.

Requirements:

A software to manipulate the data to filter out irregularities, and even to make the data accessible to other "brands" of software.

The instrument gives a large amount of data which may easily be used to determine the TOW if such a term is pre-defined for the material in question. For many materials the degradation process is of course dependant on TOW but also on the amount of water on the surface, the TOW compared to following drying-out conditions and even an reaction between TOW and other environmental factors. It would be interesting to see if the instrument could even be used to quantify the amount of water on the surface. The instrument gives an information that can be used for more than only calculating the TOW as the results show time-series of the wet-dry condition of the surface, now it is more a question how to evaluate the data to be able to compare sites.

Our experience of the instrument has thus far been good. We still plan to start the projects concerning moisture content of porous building materials and the time of wetness behind claddings. In these projects the instrument will be very important to measure the TOW.

8.8. Laboratory and field test at SIB (Peter Norberg - Swedish Institute for Building Research, Gävle)

Peter Norberg presented his work in two parts; Part 1 dealt mostly with the experiences obtained with different generations of instruments and sensors used at SIB since 1986. Part 2 summarized SIB's experience with the WETCORR method in various practical applications and presented some ideas for further use of the instruments (Appendix L).

A summary of some of his conclusions are:

Two years experiences with the new WETCORR instrument show that the results from the new instrument do not differ from those obtained by an older instrument, working according to the same measuring principle. Installation and operation of the system is very simple. Data retrieval and processing by PC require some experience and detailed knowledge about the programme structure. For routine measurements many of the steps in the evaluation process are made automatically in accordance with custom commands and criteria.

The relative standard error in the measured current between different sensors is about 20%. However, the nature of surface moisture implies that some of this variation has to do with actual differences in moisture deposition on the individual sensor.

The detection limit for relative humidity is not possible to deduce directly from the presented data. According to the arrangement of the current and relative humidity axes in the three figures presented, the lowest resolvable current, which as 1 nA, would correspond to 60% RH. Since the dependence of the logarithm of the current on relative humidity is not linear but rather quadratic, the average currents will overestimate the sensitivity. The results show that 1 nA would correspond to a relative humidity in the range 70-80% RH. This means that the present moisture sensor is less sensitive to relative humidity than a slightly different sensor previously evaluated under constant climatic chamber conditions.

The current flowing through the cell seems to be saturated at about 100-200 nA for clean sensors. Saturation can be caused by high relative humidity as well as by rain or dew. This means that just by looking at the variation in current, it seems difficult to decide whether the peaks are related to rain, dew or high relative humidity, or some combination of these and other factors. Moreover, rainfall on top of high relative humidity would not change the current response very much when saturation has occurred.

In order to avoid misinterpretation of border line cases it seems advisable to make TOW estimates for more than one current criterion.

The circumstances have not yet permitted a thorough study of the accuracy of the surface temperature transducer and neither of how relevant the obtained values are. The importance of knowing the surface temperature can be exemplified by the fact that the surface temperature measured on the coil coated sheet metal on an average was about 4 °C lower than the temperature of the ambient air. This difference implies that if the relative humidity is 80% RH or higher in the air, condensation would occur on the sheet metals as well as on the surface moisture sensor.

For the practical applications in Part 2, it was concluded that the instrument could be very useful and reliable to quantify surface moisture loads inside in buildings as well as for studying the moisture conditions in wood and painted films for in- and outside use.

Besides, a suggestion for other applications indoors as well as outdoors is put forward.

- Surfaces towards the air cavity behind wood panels
- Metallic ties and fasteners in brick cavity walls
- Surfaces between different moisture barriers and thermal insulation layers
- Foundations (slab on ground, crawl-space)
- Moisture monitoring in different roof cladding layers
- Studies of moisture conditions in various parts of windows
- Determination of actual and critical moisture conditions, e.g. in relation to frost attack of concrete and mould attack of wood
- Studies of surface condensation on walls, windows, floors etc.

8.9. Wetness impact around windows (Bengt Svennerstedt - Svennerstedt Consulting, Lund, Sweden)

His study gave clear indications of the importance of micro environmental measurements and that fairly large differences could be observed between closely related measuring points.

He stressed the fact that we need to develop an analytical model describing the connection between moisture on surfaces and the climate surrounding the structure. A part of such a model should be to develop correlation between the time of wetness threshold values selected and the deterioration processes that takes part in the materials involved. See appendix M.

9. References

- Anda, O. and Henriksen, J.F. (1991) Environmental Measurements at the Nidaros Cathedral. Lillestrøm (NILU OR 34/92) (in Norwegian).
- Bardal, E. (1985) Corrosion and corrosion protection. Trondheim, Tapir Forlag, pp. 177-201. ISBN 82-519-0700-4 (in Norwegian).
- Henriksen, J.F., Haagenrud, S.E. and Støre, M. (1993) Monitoring of the wetness impact on buildings by means of a new instrument for continuous recordings (EUREKA EU 615 EURO CARE WETCORR). UNESCO/RILEM Congress on the Conservation of Stone and other Materials. Paris 29 June-1 July 1993.
- Haagenrud, S.E. and Henriksen, J.F. (1989) A Continuous Monitor for Time of Wetness (TOW) measurements in the micro environment. Proceedings "Science, Technology and Cultural Heritage". Bologna, Italy, 13-16 June 1989 (eds. N.S. Baer, C. Sabbioni and A.I. Sors). Butterworth-Heinemann Ltd., Oxford.
- Haagenrud, S.E., Henriksen, J.F., Danielsen, T. and Rode, A. (1984) An electrochemical technique for measurement of time of wetness. Proc. 3rd Int. Conf. on Durability of Building Materials and Components. Espoo, 12-15 August 1984, pp. 384-401.

- Haagenrud, S.E., Henriksen, J.F. and Svennerstedt, B. (1985) Time of wetness measurements on wood - Pilot study with the NILU WETCORR method. Lillestrøm (NILU OR 17/85) (in Norwegian).
- Haagenrud, S.E., Henriksen, J.F. and Wyzisk, R. (1985) Electrochemical characteristics of the NILU (SCI atmospheric corrosion monitor. NACE, Corrosion 85, Boston, USA.
- Haagenrud, S.E., Kucera, V. and Gullman, J. (1982) Atmospheric corrosion testing with electrolytical cells in Norway and Sweden. In: Internat. Symp. on Atmospheric Corrosion. Hollywood, Florida, 1980. Ed. by W.H. Ailor, N.Y., Wiley, pp. 669-693.
- Lindberg, B. (1988) Measurement of TOW on painted surfaces of building materials. Scan. Paint and Printing Ink Research Inst. NIF-Report T 2-288M (in Swedish).
- Norberg, P. (1990) Monitoring of Surface Moisture by Miniature Moisture Sensors. Proc. 5th Int. Conf. on Durability of Building Materials and Components. Brighton 7-9 November 1990, pp. 539-550.
- Norberg, P. (1993) Evaluation of a new Surface Moisture Monitoring System. 6th Int. Conf. on Durability of Building Materials and Components. 26-29 October 1993, Omiya, Japan.
- Norberg, P., Sjöström, C. (1990) Time-of-wetness measurements in high-humidity compartments of dwelling. Paper I 19. Proc. Inf. CIB W67 Symp on Energy, Moisture, Elimale in Buildings, Rotterdam 3-6 September 1990.
- Norberg, P., Sjöström, C., Kucera, V. and Rendahl, B. (1993) Microenvironment Measurements and Materials Degradation at the Royal Palace in Stockholm. 6th Int. Conf. on Durability of Building Materials and Components. 26-29 October 1993, Omiya, Japan.
- Støre, M. (1994) Measurements of moisture conditions on the Nidaros Cathedral with a WETCORR instrument. Lillestrøm (NILU OR 9/94) (in Norwegian).
- Svennerstedt, B. (1987) Time of wetness measurements in the Nordic countries. Proc. 4th Int. Conf. on Durability of Building Materials and Components. Singapore, 4-8 November 1987, pp. 864-869.
- Svennerstedt, B. (1989) Measurements of surface moisture on facade materials - a Nordic project. The National Swedish Institute for Building Research. Research report TN:14 (in Swedish).
- Svennerstedt, B. (1989) Surface moisture on facade materials. The National Swedish Institute for Building Research. Research report TN:16 (in Swedish).

Svennerstedt, B. (1990) Surface moisture on facade materials. Proc. 5th Int. Conf. on Durability of Building Materials and Components. Brighton 7-9 November 1990, pp. 607-613.

Appendix A

Characteristics of the WETCORR instrument

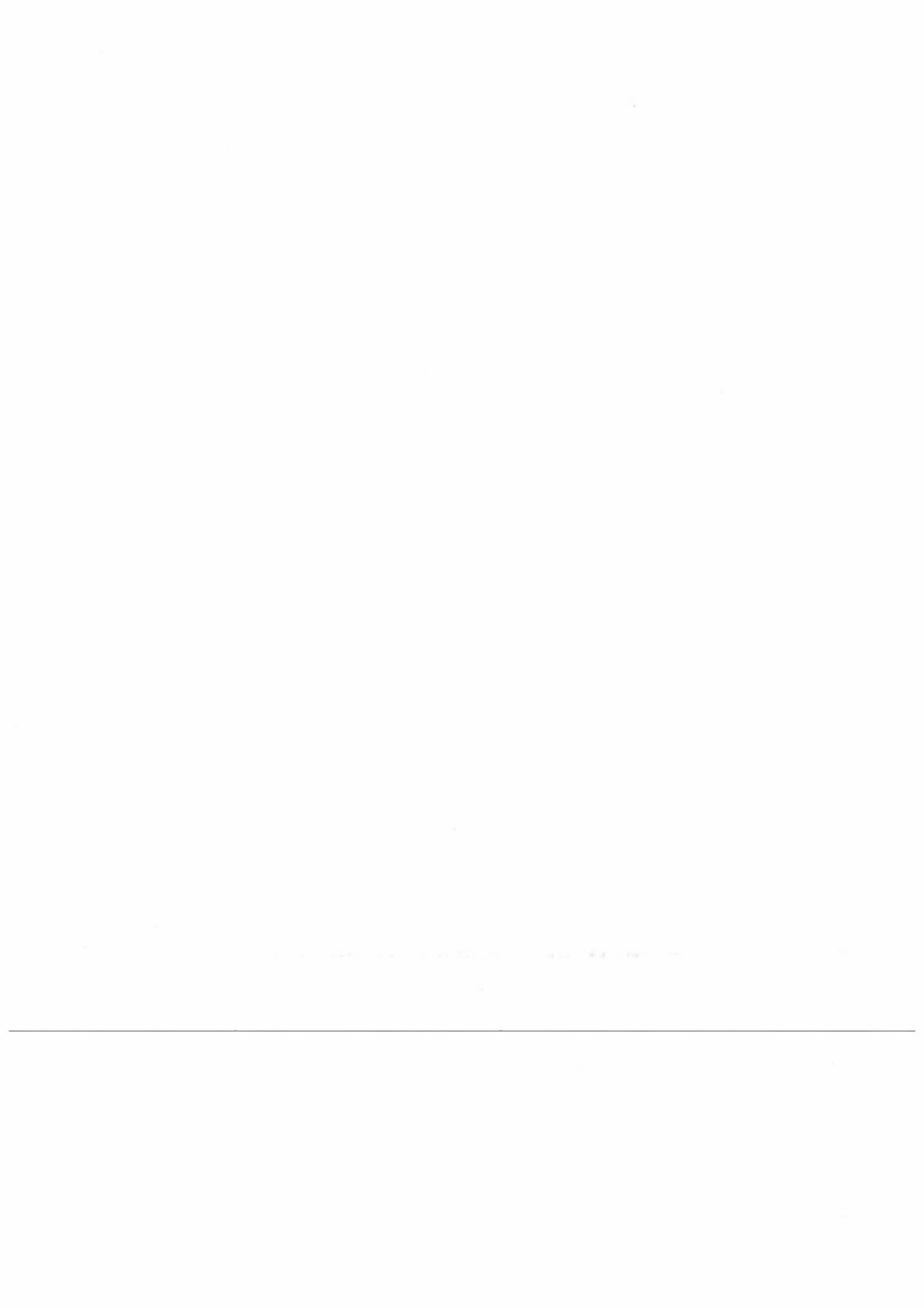

Characteristics of the instrument

The instrument is module-designed with the following parts:

- 1 System Controller (CS)
- 1-16 Sensor Adapters (AS)
- 1-64 Sensors

Each Sensor Adapter can control and record signals from four sensors.

The instrument is designed to measure the wetness at selected sites within a distance of 250 meters from the SC.

The characteristics of the parts of the instrument:

System Controller (CS)

- Controller unit for communication between the AS and SC. CS is also the centre for external communication to a PC directly or through a modem.
- Gives power to the sensors and AS.
- Sampling unit for all measuring data.

Technical data

Size	Approx. 200 x 143 x 55 mm
Capacity	Max. 16 AS with 164 sensors
Max. length cables	250 m
Working supply	12 V DC
Communication	PC/PC - MODEM
Memory size	1 Mbyte
Selected sample intervals	1,2,3,4,5, 10,15, 20, 30, 60
Applied sensor voltage	0-2V



Sensor Adapter (AS)

- Adapter unit for max. four sensors
- Measures temperature and current as an average over the sampling period
- Convert temperature and current measurements to digital signals

Technical data:

Size	170x120x30 mm
Capacity	4 sensors for each SA
Max. length of cables	2 m
Measuring range	0-1 *A
1-10 *A	
10-100 *A	
100 - 1000 A	
Resolution	0.8% of measured value
Precision	1% or better
Data speed	1200 bite/s
Power supply	9-15 V, ca. 30 mA
Operation condition	Rain proof and -25 to +85°C



Sensor

- **Measure temperature and current flow (TOW)**

Technical data

Time of wetness sensor:

Size	17 x 14 mm
Gold thickness	1.5 μm +0,25 μm
Insulation gap	127 μm +2 μm

Temperature sensor

Type	AD - 529 AN (glued to the TOW sensor)
Temperature range	-25 to +105°C
Accuracy	+ 1.5°C
Non linearity	+ 0.15°C



Conclusions from the study in 1990-91

1. The dominating gas pollutant was NO_x from the traffic with an average concentration of NO₂ of 45 µg/m³. Deposition measurements at the facade showed that the highest values were observed on the facades facing the traffic, facade west and north.
2. The east and south facades were sheltered from slashing rain and the collected run off water contained an increased amount of calcium from the mortar and little of the ions from the stones.
3. The time of wetness measurements showed large differences between the selected measuring point, indicating the importance of studying the micro environment.
4. The deterioration of the cathedral seems mainly to be influenced by climatic parameters and not by the pollutants.



Appendix B

Results from the calibration tests

THE UNIVERSITY OF CHICAGO PRESS

Calibration tests

The proposed tests contain two different steps:

Step 1: Field test with a standard set-up shown in the figure for at least two months. The main purpose was to control the spread in the results for sensors which were effected by the climate in the same way.

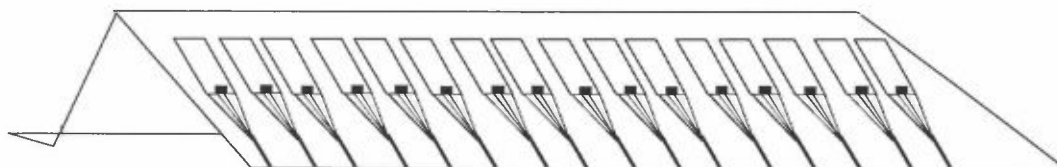

Step 2: Laboratory test with the same sensors used after the field test. The test was carried out under climate control when the temperature was kept constant and the relative humidity was changed in steps from 40% to 90% and 95%. An artificial rain was introduced at the end of the cycle. The artificial rain water had a pH = 4 and a small amount of chloride, 10 mg Cl/l.

Results

The complete test was carried out by the Danish Institute for Building Research and the Norwegian Institute for Air Research. The field test as described or slightly modified was carried out at the Norwegian Institute for Building Research, the Swedish Institute for Building Research and the Swedish Corrosion Institute.

Current

A comparison between the different cell responses showed that even if the measured value between the sensors could be different, the graph of the current output had the same shape and that the calculated time of wetness will be comparable. An illustration is given in Figure B.1.

The results from all the sensors tested at NILU's roof during the same period, are given in Table A.1.

The spread in the measured current outputs and in the calculated time of wetness for threshold current (i_{thres}), 20 nA and 30 nA, was comparable for all the results given. The calculated TOW with $i_{\text{thres}} = 20$ nA had the lowest spread, 10.8%. The spread in TOW is lower than the spread in the average current of the sensors, 14,8%.

A comparison between the results from standardized tests in the Nordic countries are shown in Table A.2. At NILU and the first months at SIB the spread is low, mostly below 10%. With time the spread and the current output increase at SIB. After 8 months the threshold value must be adjusted to 100 mA to get a reasonable reading.

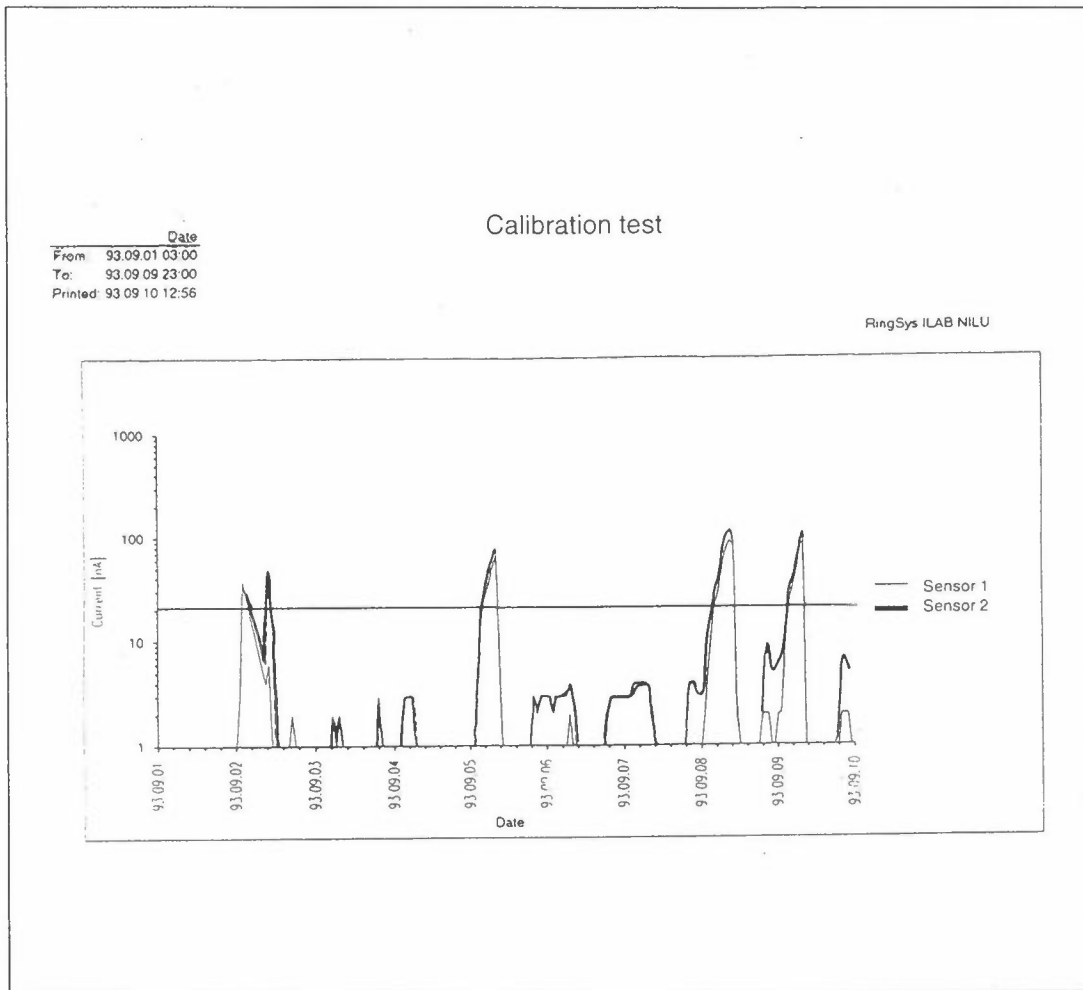

Figure B.1: A comparison of the current output from two parallel mounted wetness sensors.

Table A.1: The results of the current output from NILU's roof laboratory the period 930901-930909. The time of wetness (TOW) has been calculated for two different threshold currents, 20 nA and 30 nA.

Adapter	Sensor	Current output			Calculated TOW in %	
		Average	Min.	Max.	20 nA	30 nA
03	1	5.24	0	79	9.18	6.76
	2	5.53	0	100	9.73	6.28
	3	5.19	0	102	7.25	5.31
	4	6.28	0	97	9.66	7.73
04	1	5.81	0	91	8.70	6.76
	2	8.01	0	119	10.14	8.21
	3	5.94	0	99	9.18	7.25
	4	6.56	0	98	9.18	6.76
Mean values for the 8 sensors		6.07 ± 0.9	0	98.1 ± 11.2	8.88 ± 0.96	6.88 ± 0.89

Table A.2: The average monthly time of wetness data in & measured at different institutes in the Nordic countries. TOW is calculated for the threshold currents 20 nA, 30 nA, 100 nA.

Monthly results from parallel sensor exposure	SBI (8 sensors)		SIB (6 sensors)			NILU (7 sensors)		NTH	
	TOW %		TOW %		TOW		TOW %		
	20 nA	30 nA	20 nA	30 nA	20 nA	30 nA	20 nA	20 nA	
1st month	43.5 ± 8.0	29.8 ± 9.8	75.8 ± 5.7	69.1 ± 7.6	28.5 ± 1.7	19.9 ± 2.5	6: 4.3 ± 3.1 2: 62.4 ± 4.4	26.6 ± 4.2 61.7 ± 5.2	
2nd month	49.1 ± 19.7	31.1 ± 8.1	77.1 ± 7.9	69.8 ± 8.7			5: 0.6 ± 0.02 3: 14.6 ± 0.9	0.4 ± 0.3 13.0 ± 0.6	
3rd month	48.5 ± 21.7	31.6 ± 7.7	63.2 ± 15.2	53.2 ± 15.4	28.2 ± 1.8	23.2 ± 2.0			
5th month			68.1 ± 29.4	60.4 ± 36.4					
8th month			~ 100	100	56.7 ± 35.1				

It is also obvious that the spread between the parallels increases with time, probably because of small changes in the pollutant layers formed on the surface. This effect seems to occur both at SBI and NTH, where the time of wetness results are more or less divided in two groups.

Particularly the test at NTH gave extreme differences. For the first month 6 sensors got a TOW value of $34.3 \pm 3.1\%$, while the 2 sensors got twice as much, $62.4 \pm 4.4\%$. The second month contains results for only one week, but with the same trend. Local salt contamination of the sensors could be a reasonable explanation for the phenomenon, but this is not proved.

The laboratory tests at the end of the calibration test was only carried out at SBI and NILU. In Figure B.2 the results from this test are shown. The baseline was quite different at SBI and NILU. However, for both laboratories the response for increased humidity is zero before we introduced the rain. These results are in accordance with the theory described in Chapter 4.

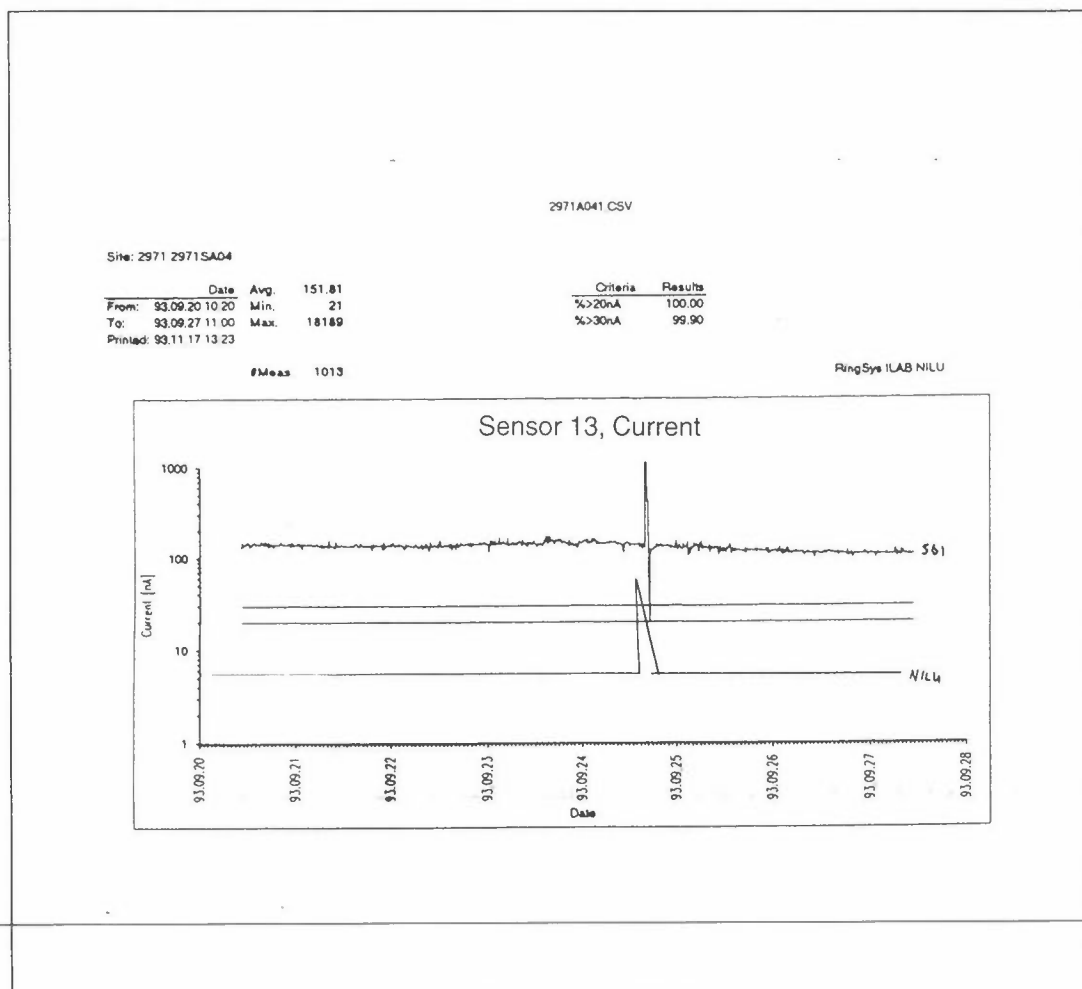
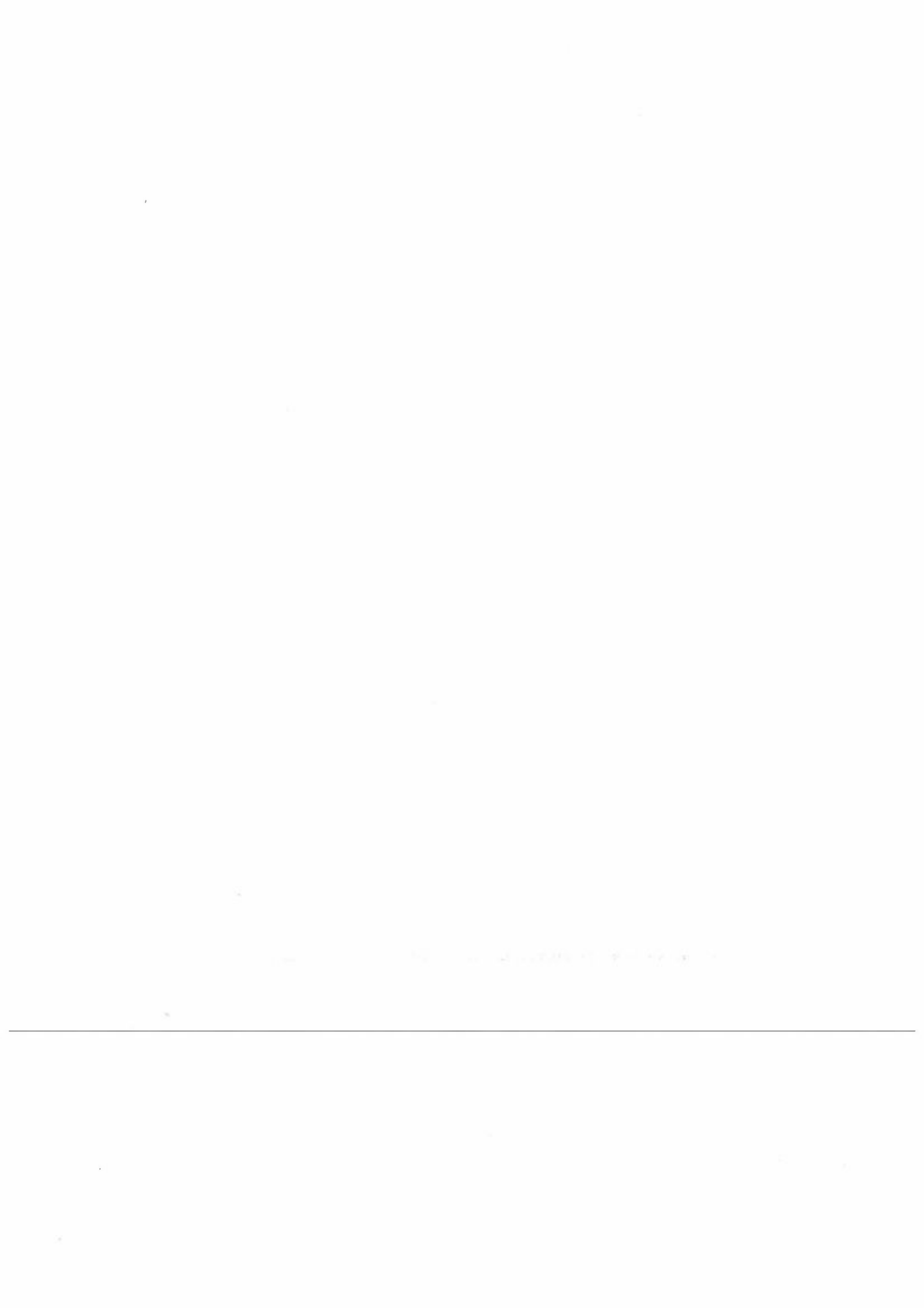

Figure B.2: A comparison of the climatic chamber test performed at SBI and NILU after 8 weeks of outdoor exposure.

Table A.3: The temperature results from NILU's roof laboratory for the period 930901-930909. The results are adjusted with the calibration factor given by the producer.

Adapter	Sensor	Average temp. \bar{T}	Min. temp. $T_{\min.}$	Max. temp. $T_{\max.}$
03	1	11.7	-3.5	37.0
	2	9.5	-5.8	35.1
	3	12.9	-2.0	38.7
	4	11.2	-3.5	37.0
04	1	11.3	-4.0	38.0
	2	12.4	-3.3	39.9
	3	11.9	-3.6	39.0
	4	12.0	-3.5	38.6
Mean values for the parallel temperature sensors		11.6 ± 1.0	-3.7 ± 1.0	37.9 ± 1.5



Appendix C

Data presentation package

© 2014 by the author(s). All rights reserved. No part of this publication may be reproduced, stored in a retrieval system, or transmitted, in any form or by any means, electronic, mechanical, photocopying, recording, or by any information storage or retrieval system, without the prior written permission of the author(s).

WETCORR presentation program

- Database
- Communication module
- Graphing module

WETCORR presentation program

wc1a.ppt TK 93.07.11



Requirements

- IBM-compatible PC
- 80386 33MHz processor
- 4 Mb RAM
- VGA or SVGA colour monitor
- Printer
- Telephone modem
- Windows 3.1

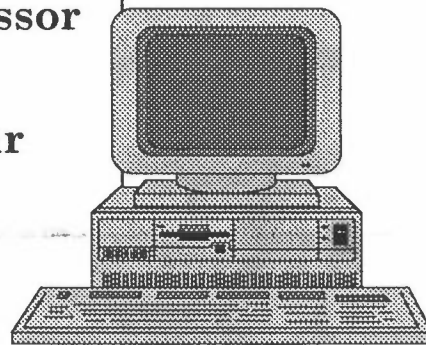

WETCORR presentation program

wc1a.ppt TK 93.07.11



Database

- Database created in Microsoft Access
- Data may be manipulated in Access for advanced computations (Access not included)
- Normal data handling in Windows application created in Microsoft Visual Basic

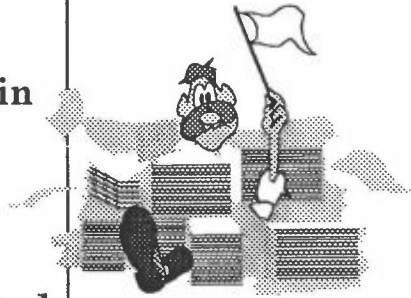

WETCORR presentation program

wc1a.ppt TK 93.07.11



Database structure

- Station table
- Experiment table
- Data table
- Several database files available, only one open. Each file contain multiple stations and experiments.

WETCORR presentation program

wc1a.ppt TK 93.07.11



File selection window

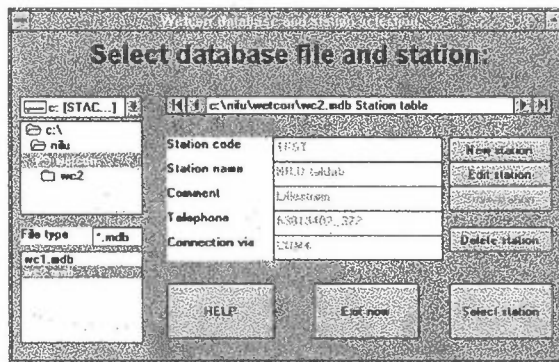

- Select file
- Select station
- Edit station

WETCORR presentation program

wc1a.ppt TK 93.07.11



Data input

- Wetcorr ASCII files
- Automated telephone connection to Wetcorr
- Database prevents duplicate records

WETCORR presentation program

wc1a.ppt TK 93.07.11



Presentation

- **Define query**
 - Select experiment
 - Select parameters
 - Select period
- **Display plot**
- **Print or save results**
- **Copy results to word processor**

WETCORR presentation program

wc1a.ppt TK 93.07.11



Graphics

- **Standard Windows graphing tools**
- **Extended possibilities with BASIC programming**
- **Wetcorr templates**

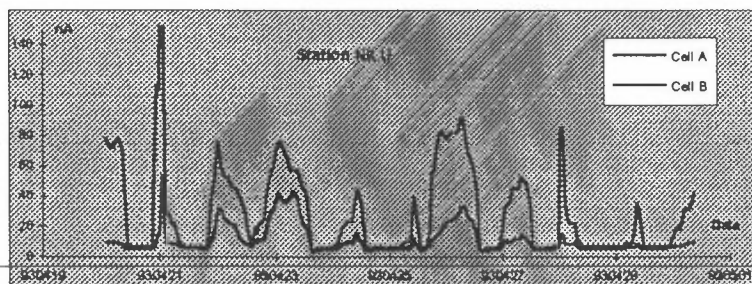

WETCORR presentation program

wc1a.ppt TK 93.07.11



Appendix D

ABB sales offer

ABB

ASEA BROWN BOVERI

Antall ansatte 215.000

Driftsinntekter NOK 190 milliarder

ABB Energi
nr. 215/94

Wetcorr™

Geir Vollebæk

Marketing Manager
Environmental IT & Control Systems

NILU OR 37/94

Environmental Information Systems



- Wetcorr™** Environmental Impact Measuring
- Envi-Save™** Wastewater Control System
- Aqua-Safe™** Pure Water Control
- CRM™** Continuous River Monitoring System
- MiniSCADA™** Supervision Control System

ABB
ABB

ABB
ABB

Wetcorr™

The System



ABB
ABB

ABB
ABB

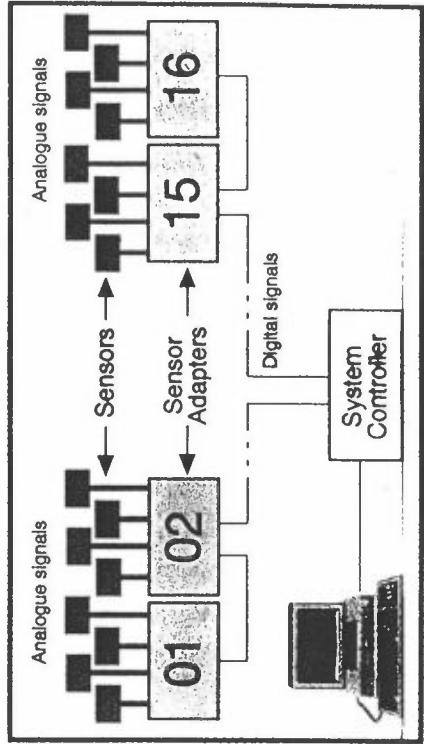

Applications

Environmental Impact Measuring System

- **Measuring surface moisture**
- **Measuring the Time of Wetness (TOW)**

= Knowledge about degradation of materials and structure



Delivery time

- Number of units
- New version of the software
- Delivery-time on the component marked
- Reception of order
- Internal production time
- Conclusion : 4 months

Future support

- Datasheets for sw
- Datasheets for hw
- Establish Wetcorr User Group
- Product support
- Further development of system
- Further development of system components
- Feedback from users

- 1 Systemcontroller NOK 13.800,-
- 4 SensorAdapters NOK 24.400,-
- 1 WetcorrSYS NOK 7.100,-
- 16 cells NOK 6.400,-
- cables on demand
- TOTAL price NOK 51.700,-

System Software

- DOS 5.0 or later included in hw
- Windows 3.1 NOK 1250,-
- Excel 4.0 NOK 2990,-
- pcANYWHERE NOK 2990,-
- RingSYS NOK 3200,-
- WetcorrSYS NOK 7100,-



WetcorrSYS

- Using Microsoft Windows technology
- Using Microsoft Access database
- Using Microsoft Visual Basic program
- Preprogrammed applications for simple data access and presentation
- Simple installation
- Program is under development

Appendix E

WETCORR monitoring at the Royal Palace of Stockholm

Wetcorr monitoring at the Royal Palace of Stockholm

Peter Norberg, SIB, GÄVLE, Sweden

Introduction

The Wetcorr technique is being employed as part of the Eurocare WetDry-Dep project currently performed at the Royal Palace in Stockholm. The overall aim of this project is to provide knowledge on the influence of wet and dry deposited air pollutants on corrosion and service life of a selection of important building materials and coatings in different positions of buildings. The project is a joint activity between SIB and the Swedish Corrosion Institute. The contents of the following text are extracted from Norberg (1993) and Norberg et al (1993).

Measuring conditions

An overview of the various test positions employed and of the measurements performed are given in the attached figures and tables. The surface moisture measurements started in February 1992 and are still running.

Specially designed test racks have been installed at the different positions of the façades. The racks were designed in two versions, one with rain shelter and one without. Surface moisture measurements are made at 5 different positions. The sensors are mounted in pairs on a Zn-panel using double stick adhesive. All positions are open except for position 12 which is equipped with sensors in both sheltered (12S) and partly sheltered (12P) locations on the rack. Position 15 is situated on the roof of the palace and is oriented at 45° southward. All other positions involve vertical racks.

A reference site was erected close to position 15 in June 1992 for measurements of atmospheric conditions, such as air relative humidity and temperature, rainfall, wind speed and direction, pollution deposition, etc. In this way, detailed comparison of surface moisture measurements and TOW-estimates can be made with the climate factors monitored.

Results

The two parallel sensors, installed at the reference site on the roof of the Royal Palace, have shown almost identical currents ever since the beginning of the test in February 1992, i.e. almost two years up to now. One of the figures presented shows the current variation for one of the moisture sensors during an arbitrary week last autumn, together with the relative humidity and the accumulated rainfall. As already stated elsewhere, there is a strong dependence of the current on the relative humidity. In the figure shown, the impact of rainfall can also be studied.

Additional information needed to explain the sensor response, at least qualitatively, is given by the temperature or rather the difference between the ambient and surface temperature, see the attached illustration. In this figure is also shown the UV-radiation, which gives a rough indication of days with a clear sky in daytime and thereby substantially higher surface temperatures. During clear nights, on the other hand, the surface will be cooler than the ambient air due to the radiation of heat to the cold sky. Effects related to such conditions may be observed for the nights of 26, 27 and 30 October, when the recorded current was lower than would be expected from the relative humidity. In the summer this condition would lead to a higher current due to the enhanced formation of dew.

TOW for the considered week was calculated to 38, 23 and 1% using the three criteria 10, 30 and 100 nA, respectively. According to ISO 9223, TOW would be 28%, but only a smaller fraction of this time would coincide with that experienced by the moisture sensors. The reason is that ISO only considers temperatures above 0°C, whereas the Wetcorr method can give considerable currents also below this temperature. On the other hand, Wetcorr may result in low currents also when the relative humidity exceeds 80 %RH, which is the other criterion used by ISO to estimate TOW. This discrepancy would of course be less pronounced during warmer periods of the year.

A comparison of the duplicate sensors and of the different positions around the palace show that the shortest time of wetness, as evaluated for a current criterion of 30 nA, is experienced by the reference site on the roof. More than twice as long TOW is seen for positions 7 and 12. This would be expected for position 7 which is close to Norrström and facing north, but not for position 12 facing west.

If the time of wetness is evaluated for two test periods, February-June and July-December, it becomes evident that the latter period gives rise to much longer TOW for positions 12S and 12P than expected from a comparison with the other positions.

Discussion and conclusions

The measurements of surface moisture and TOW using the Wetcorr method show results that are, in principle, consistent with the anticipated moisture situation at the Royal Palace. In sheltered positions, however, effects of pollution deposition can be observed in the recorded current. The reason for this is probably contamination of air pollutants or possibly dust from the restoration work currently being performed at the palace. Whatever source, the contaminants contribute to an increased electric conductivity of the moisture film adsorbed on the sensor grid. Owing to its sheltered position, there will be no natural rinsing or cleaning of the sensor, as is the case, more or less, at the unsheltered positions.

It should be mentioned in this context that the results obtained during the second year of measurement show a similar contamination effect for the sheltered sensors. The time when this has become evident seems also to be the same both years, namely, in July.

The different positions at the palace show that, on an average, the longest TOW is about 2-3 times longer than the shortest TOW.

During cold periods, there is only a fair agreement between TOW measured by Wetcorr and that estimated from ISO 9223. This seems mainly be due to the fact that ISO 9223 only considers temperatures above 0°C.

References

Norberg, P. (1993) Evaluation of a new surface moisture monitoring system. **Proc. 6th Int. Conf. on Durability of Building Materials and Components**, Omiya, Japan, 26-29 Oct, 1993, pp 637-646.

Norberg, P. Sjöström, Ch. Kucera, V. and Rendahl, B. (1993) Microenvironment measurements and materials degradation at the Royal Palace in Stockholm. **Proc. 6th Int. Conf. on Durability of Building Materials and Components**, Omiya, Japan, 26-29 Oct, 1993, pp 589-597.

Map of the Royal Palace showing the various test sites employed

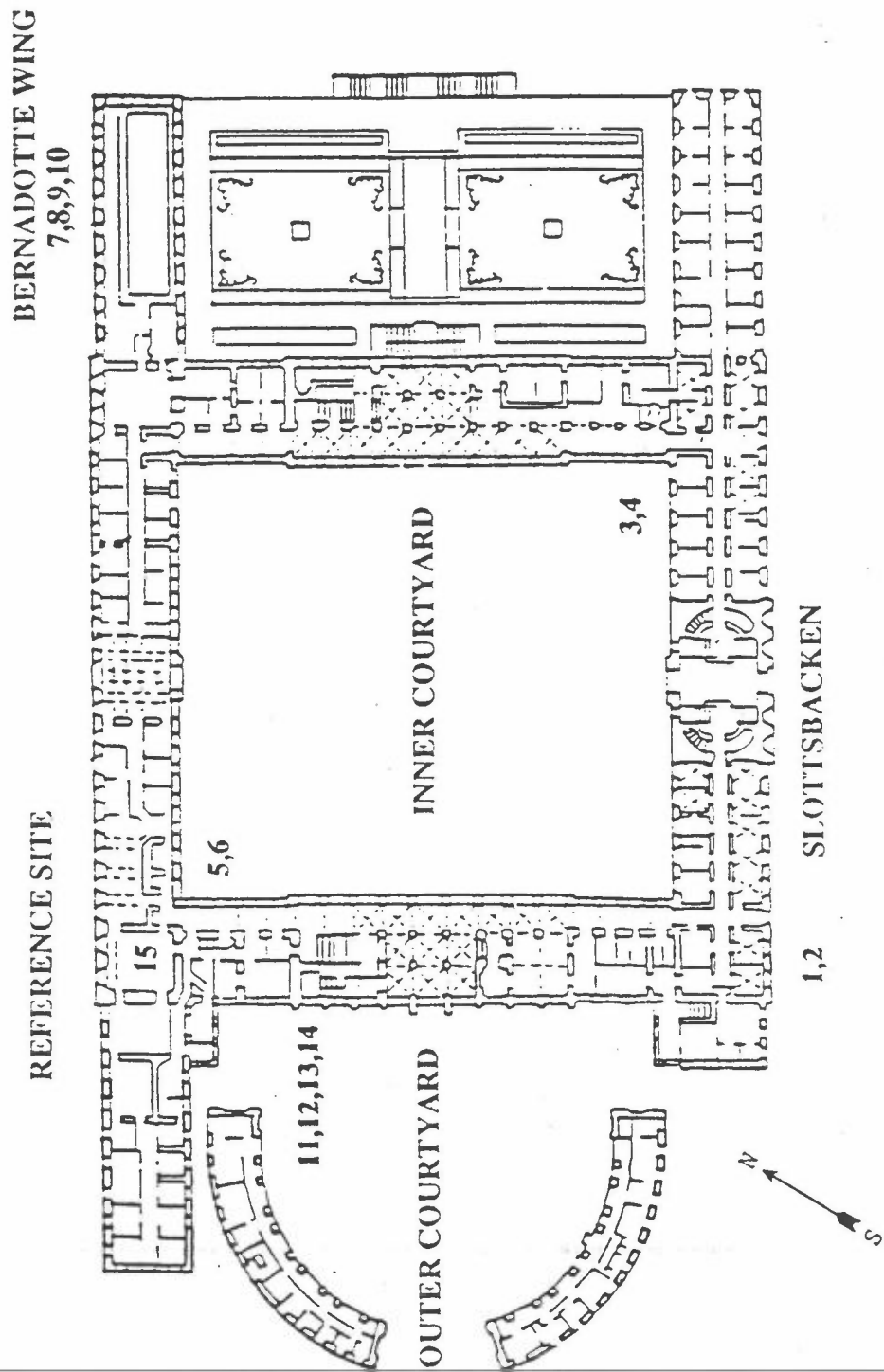

Test positions and measurements

Test position	Level	Rain shelter	Wetcorr	UV	Deposition SO ₂ NO ₂	Concentration SO ₂ NO ₂
1. Slottsbacken	20 m		x		x	x
2. Slottsbacken	5 m				x	
3. Inner courtyard	5 m			x		x
4. Inner courtyard	5 m	x			x	
5. Inner courtyard	5 m		x			x
6. Inner courtyard	5 m	x			x	x
7. Bernadotte wing	20 m		x			x
8. Bernadotte wing	20 m	x			x	
9. Bernadotte wing	5 m			x		x
10. Bernadotte wing	5 m	x			x	x
11. Outer courtyard	20 m					
12. Outer courtyard	20 m	x	x		x	x
13. Outer courtyard	5 m			x		
14. Outer courtyard	5 m	x			x	x
15. Reference site	roof		x	x	x	x

Monitoring of climatic factors at the Royal Palace

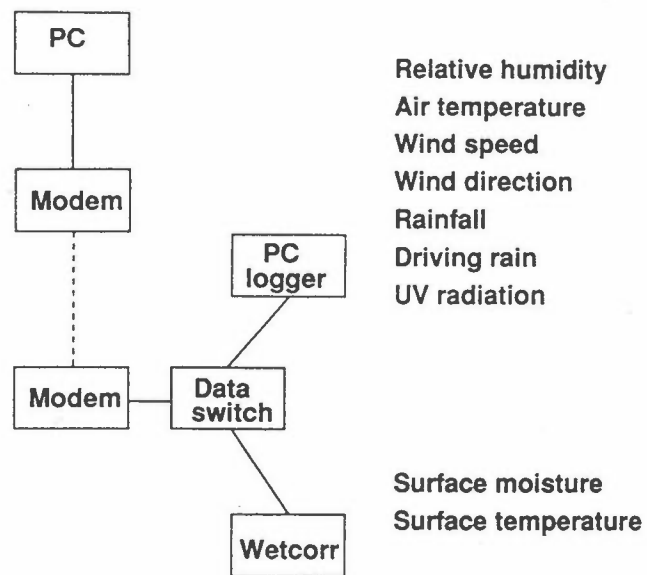

Comparison of current, RH and rainfall during one week

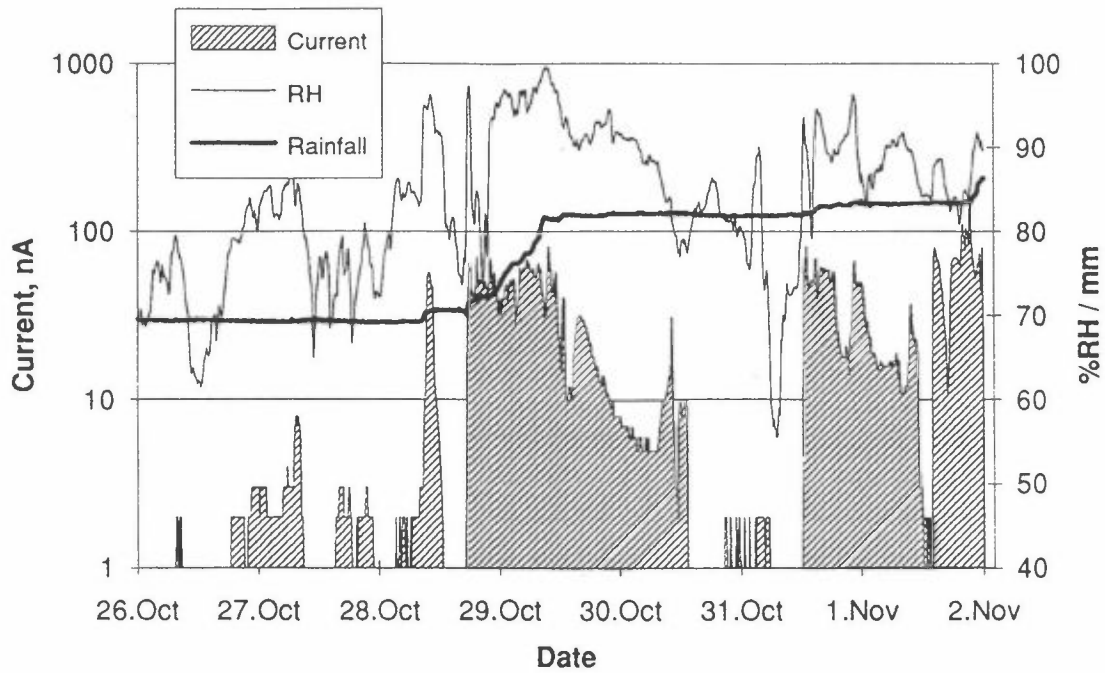

Temperature and radiation measurements during one week

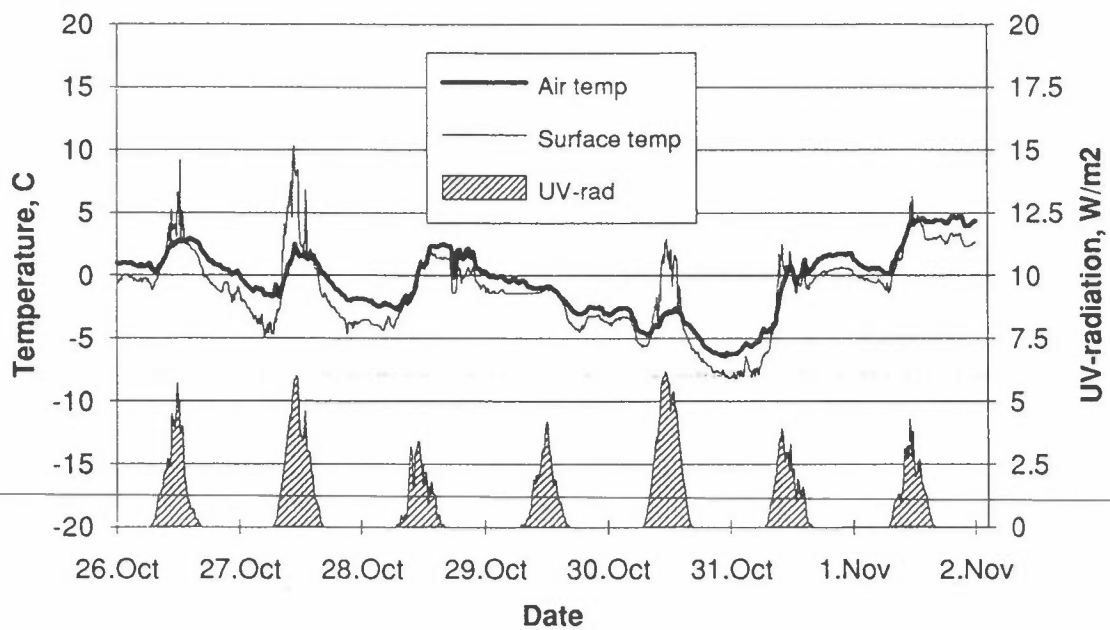

Average time of wetness (TOW)
during the period Feb-92 to Jan-93

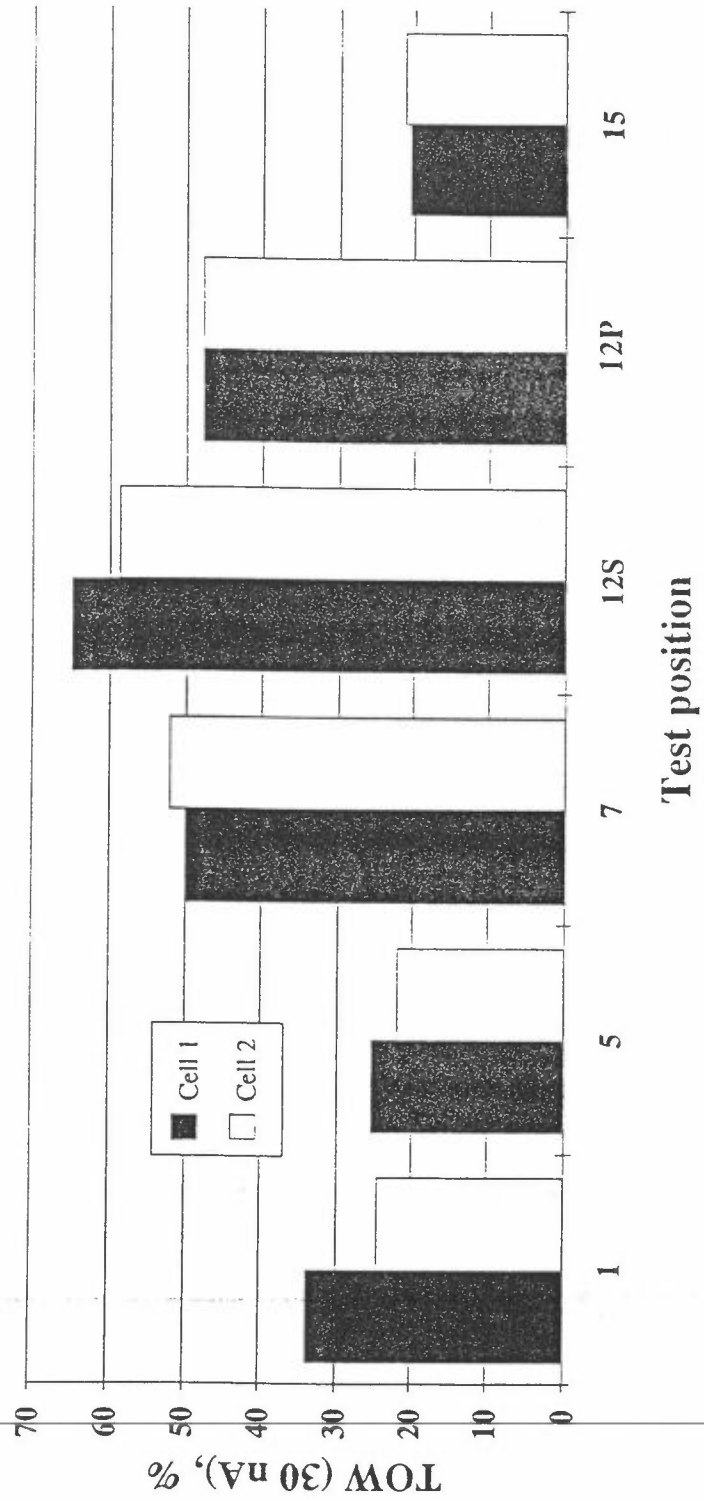

TOW comparison of two exposure periods

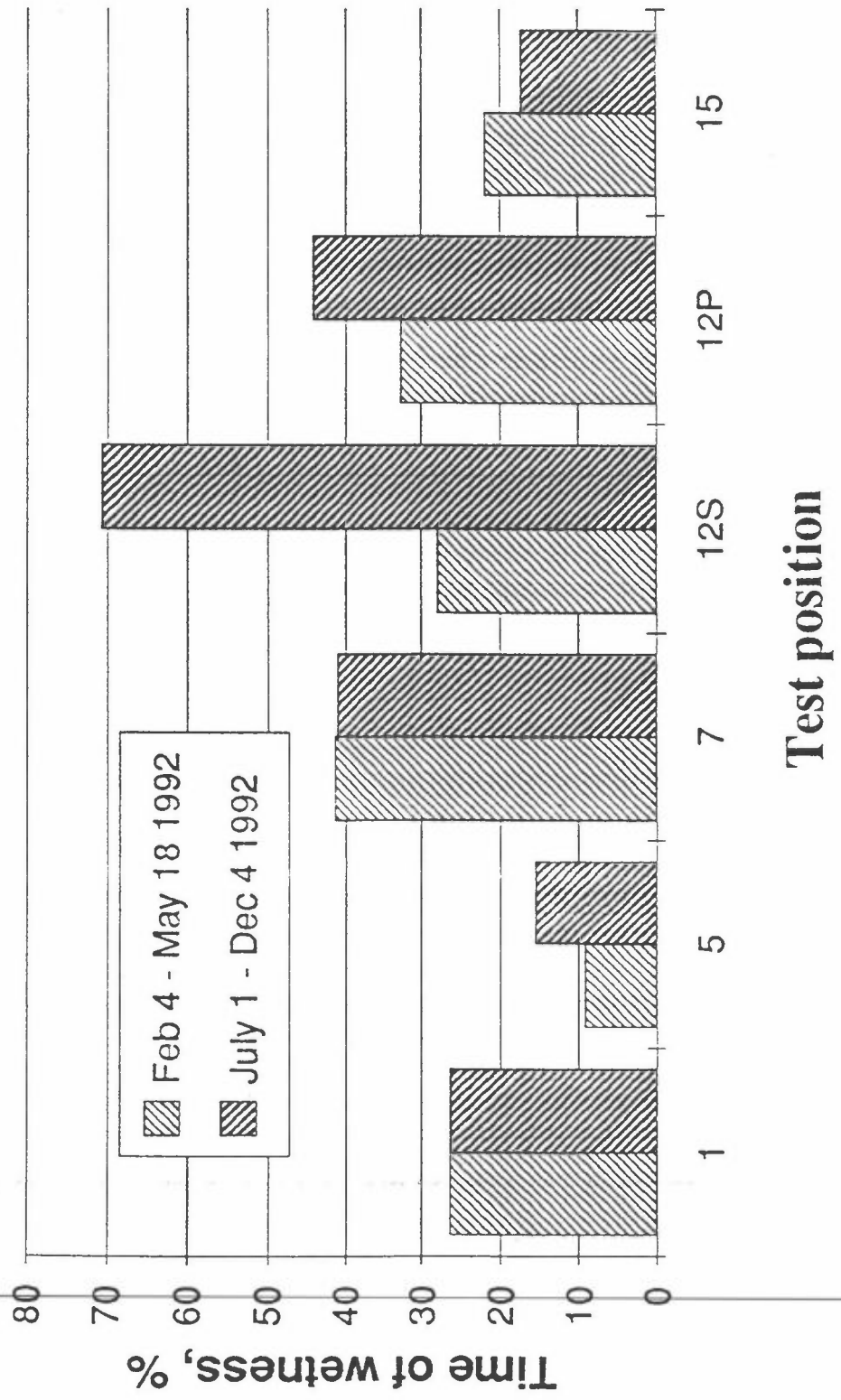

Conclusions

Microclimate

- * **Time of wetness (TOW) varies considerably with test position and time of the year**
- * **In sheltered positions, the observed TOW is affected by pollution deposition**

Appendix F

WETCORR monitoring at Nidaros Cathedral, Trondheim

2025-2026 2024-2025 2023-2024 2022-2023 2021-2022 2020-2021 2019-2020

WETCORR monitoring at Nidaros Cathedral, Trondheim

Jan F. Henriksen and Marit Støre, NILU, Kjeller, Norway

1. Introduction

Nidaros Cathedral in Trondheim is the most prestigious soapstone building in Norway, but has several deterioration problems. To study some of these problems, mapping of the wetness impact on different parts of the facades was carried out. The investigation was performed at two different facades during autumn and winter 1992-93. The two facades were:

- The East chapel, which is the oldest part of the cathedral where all stones are thoroughly characterized and dated.
- The West facade, which is the newest part of the cathedral and where the facade is completely decorated with statues and ornaments.

2. The measurements on the East chapel

In autumn 1992 the study of the octagon of East chapel was carried out. This part of the church is hardly ever affected by rain, nevertheless substantial stone deterioration has been observed on most of the stone facade. The basic thought has been that deterioration products absorb water during high humidity conditions and recrystallize during dry periods. To study this idea 16 cells were applied to the octagon. Two of the cells were put up out from the wall as references for detecting the main events with rain and the air temperature. The 14 cells were attached on the walls, 4 on the south, 6 on the east and 4 on the north side. To study the effect of the deterioration products, 6 of the cells were treated with a slurry of water and deterioration product and then dried before the cells were attached; the other cells were kept clean. In this way a comparison can be made between the results for the reference rain cells, the same clean cell on the wall for drifting rain, and the cell contaminated with hygroscopic salts. The set-up is shown in Figure F.1.

The results from the period 5th to 19th October 1992 are used to explain the main trends observed (Figures F.2 and F.3). The reference cell (cell 1) recorded rain for most of the period 7th to 13th October. Actually the precipitation measured on the 8th October was the largest ever observed in Trondheim. From the 14th October the weather improved with clear sky and low temperatures for the rest of the period. The cell was facing south and the sun hits the cell in the middle of the day around 12 o'clock. This led to a sharp increase temperature on the 5th, 9th, 14th, 15th, 16th, 17th and 18th October. The measurements from the cells on the wall were quite different. Only on the rainy days, 8th and 10th October, the current of the clean cells increased for a short time to a level where we could describe the cells as wet. The clean cells gave low reaction, but the small changes in the current observed gave the same pattern as the contaminated ones. The current flow of the contaminated cells was of the same magnitude as for the reference. However, the changes with time are much smaller and the cell dried out only on the evening 15th October. The next day dew had formed on the cell and the

current was high again. This took place even if the temperature of the cells was below 0°C . This indicates that the deterioration product has formed an electrolyte with lower freezing point than 0°C . The results are comparable for all three sides and showed that absorption and desorption of water took place on the stone surface. This mechanism contributes to the deterioration processes by salt crystallization on the surfaces. The deterioration processes are intensified by the fact that the surface never is washed off with rain. Even on the days with extreme rain, the washing off effect was missing.

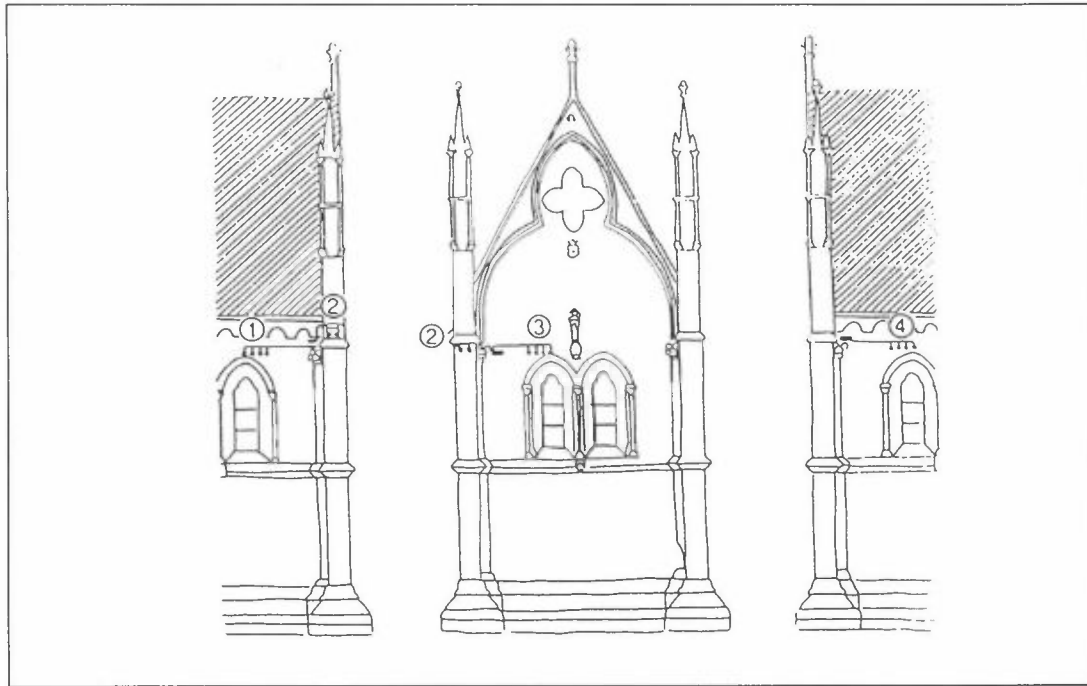

Figure F.1: The monitoring set-up at the East chapel.

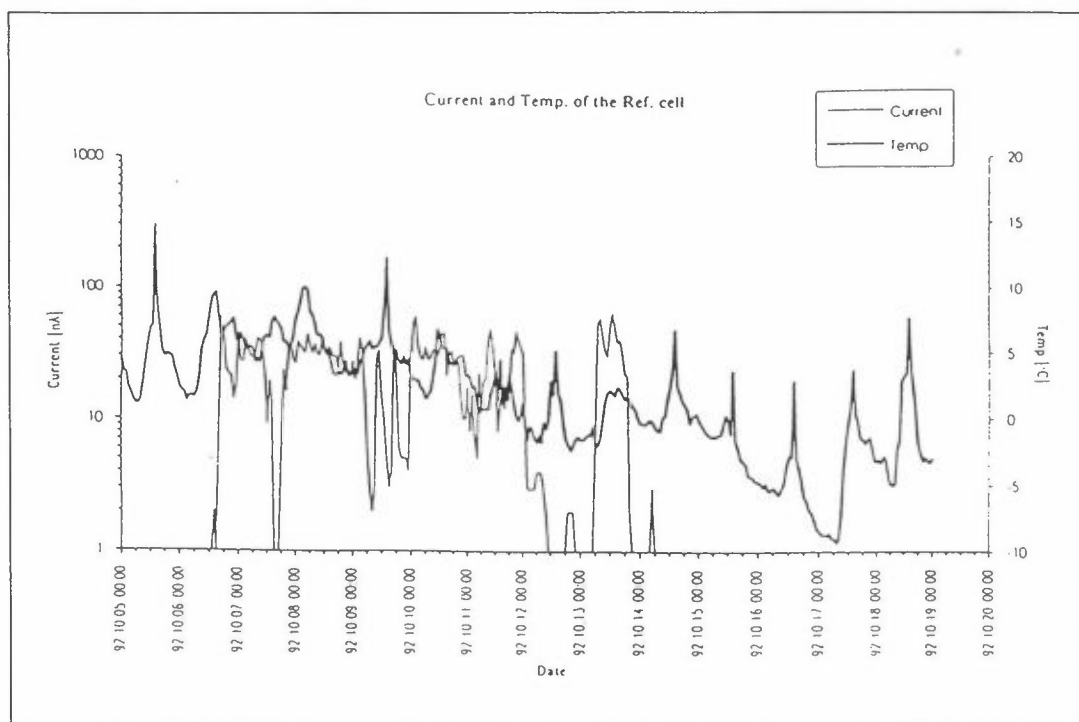

Figure F.2: The wetness and temperature measurement of the reference cell in the period 5th to 19th October 1992.

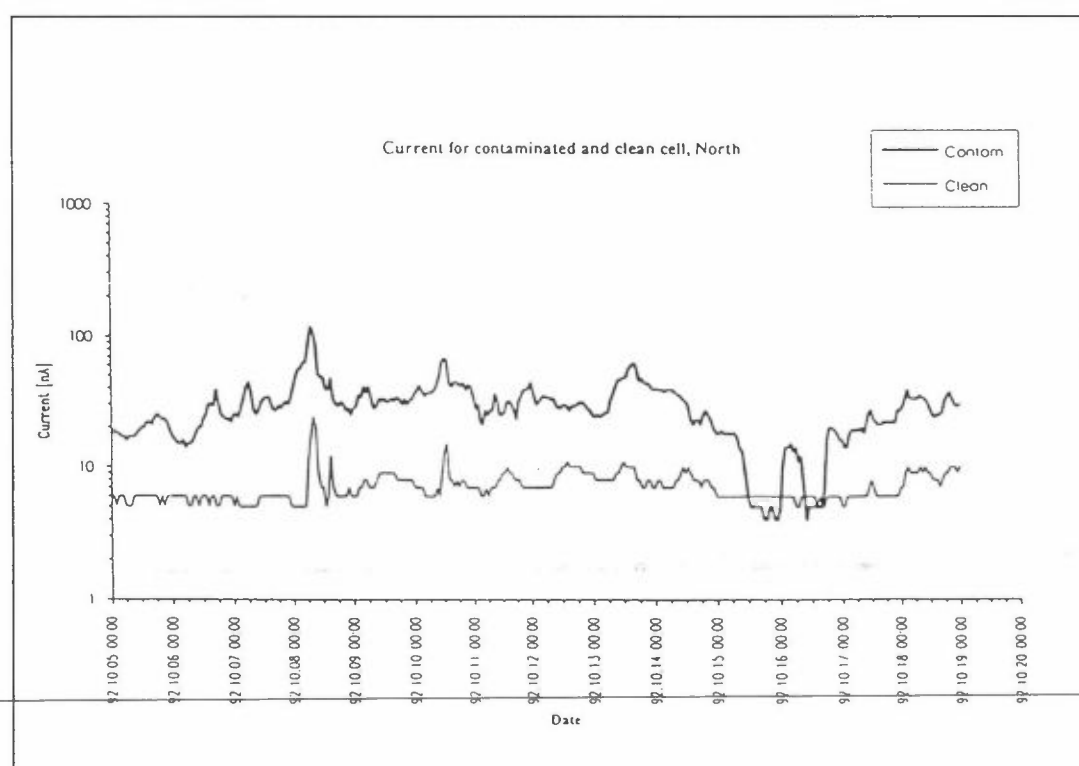

Figure F.3: The wetness measurements on clean and contaminated cells on the wall of the East chapel of the Nidaros Cathedral in the period 5th to 19th October 1992.

3. The measurements on the West facade

The measurements were carried out through the winter and spring 1993. Since it was known that the facade was effected by slashing rain, the sensors were set up to study the different wetness impact at different parts of the facade from freely exposed areas to more complete sheltered areas. The set-up is shown in Figure F.4. The best set-up for reference electrodes was tested by selecting to area close together with the same slope, but two were facing west and two east. The results given in Figure F.5 clearly show the great effect of the sun heating up the west facade sensors and thereby reducing the total wetness impact.

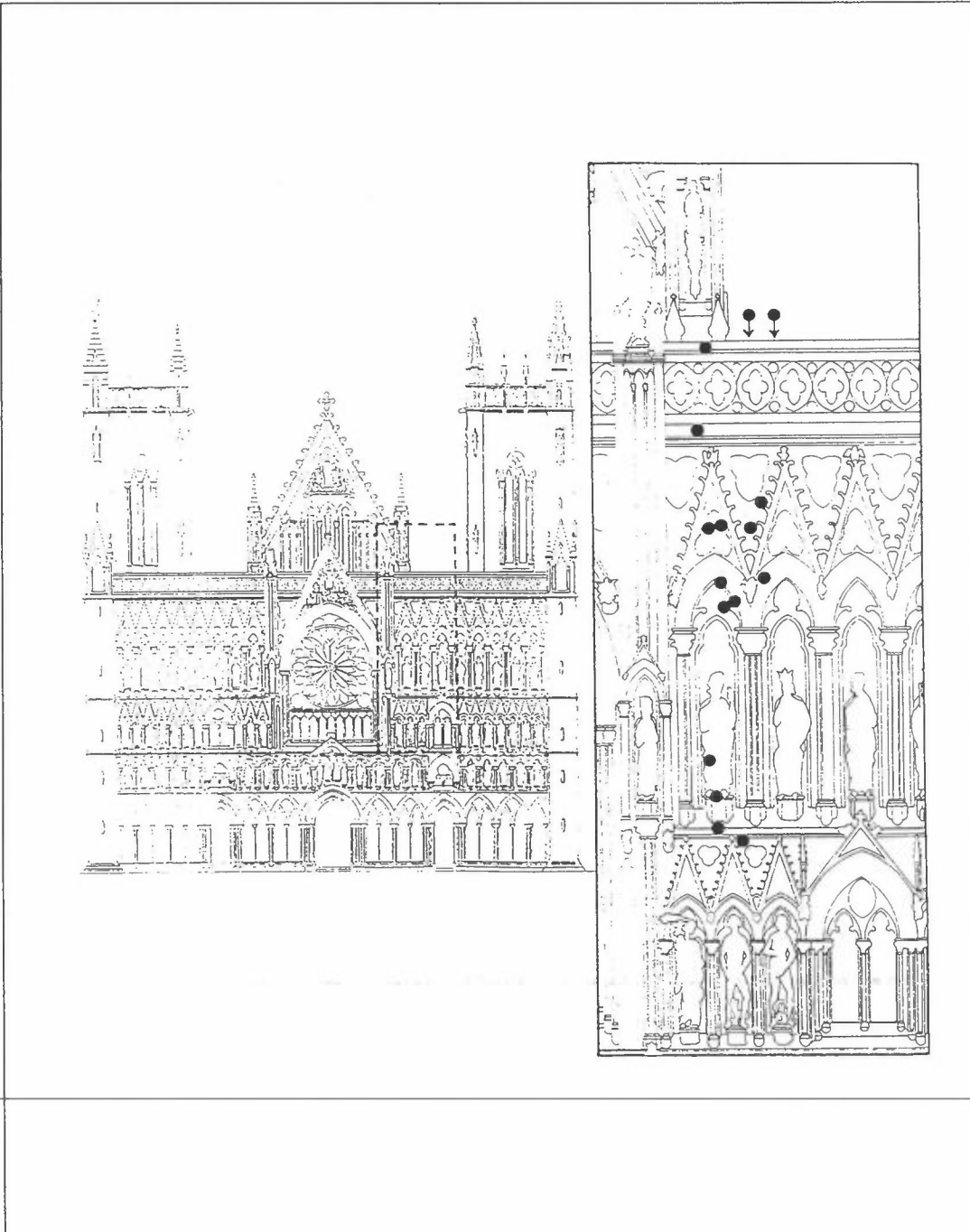

Figure F.4: The West facade with the set-up of the WETCORR sensors.

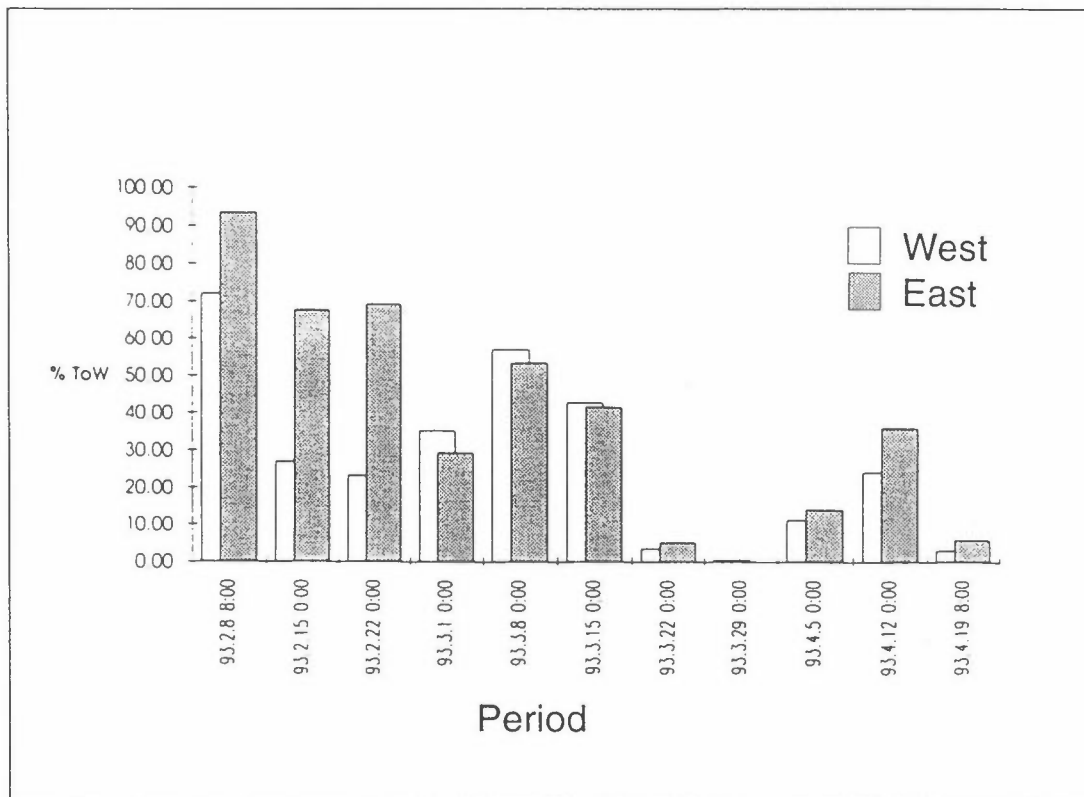

Figure F.5: The total time of wetness (TOW) measured with reference sensors facing west and east.

4. Main conclusions

The deterioration processes are different on different parts of the building. On the East chapel deposition of hygroscopic salts and hygroscopic deterioration products seems to play an important role because of recrystallization that takes place at intervals.

On the West facade the slashing rain and penetration of water into the structure are the greatest problems even if deposition of hygroscopic salt could play an important part in sheltered positions.

Reference sensors freely exposed to rain are important for the evaluation of wetness impact on different parts of a building. The test made on the West facade showed that the place for the reference sensors should be selected carefully and that sunshine heating up the stone surface will effect the total time of wetness to a large extent.

Appendix G

WETCORR instrument used in the UN/ECE-ICP project

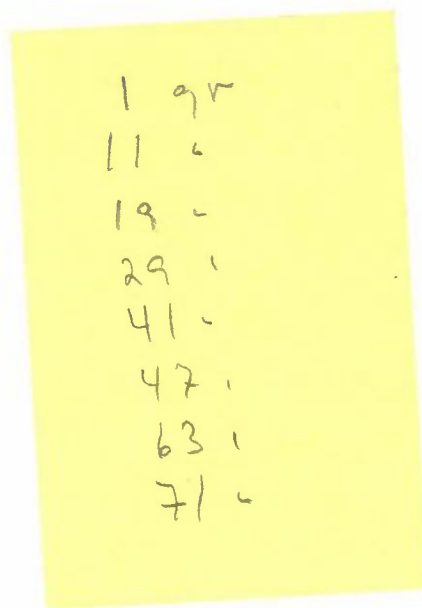

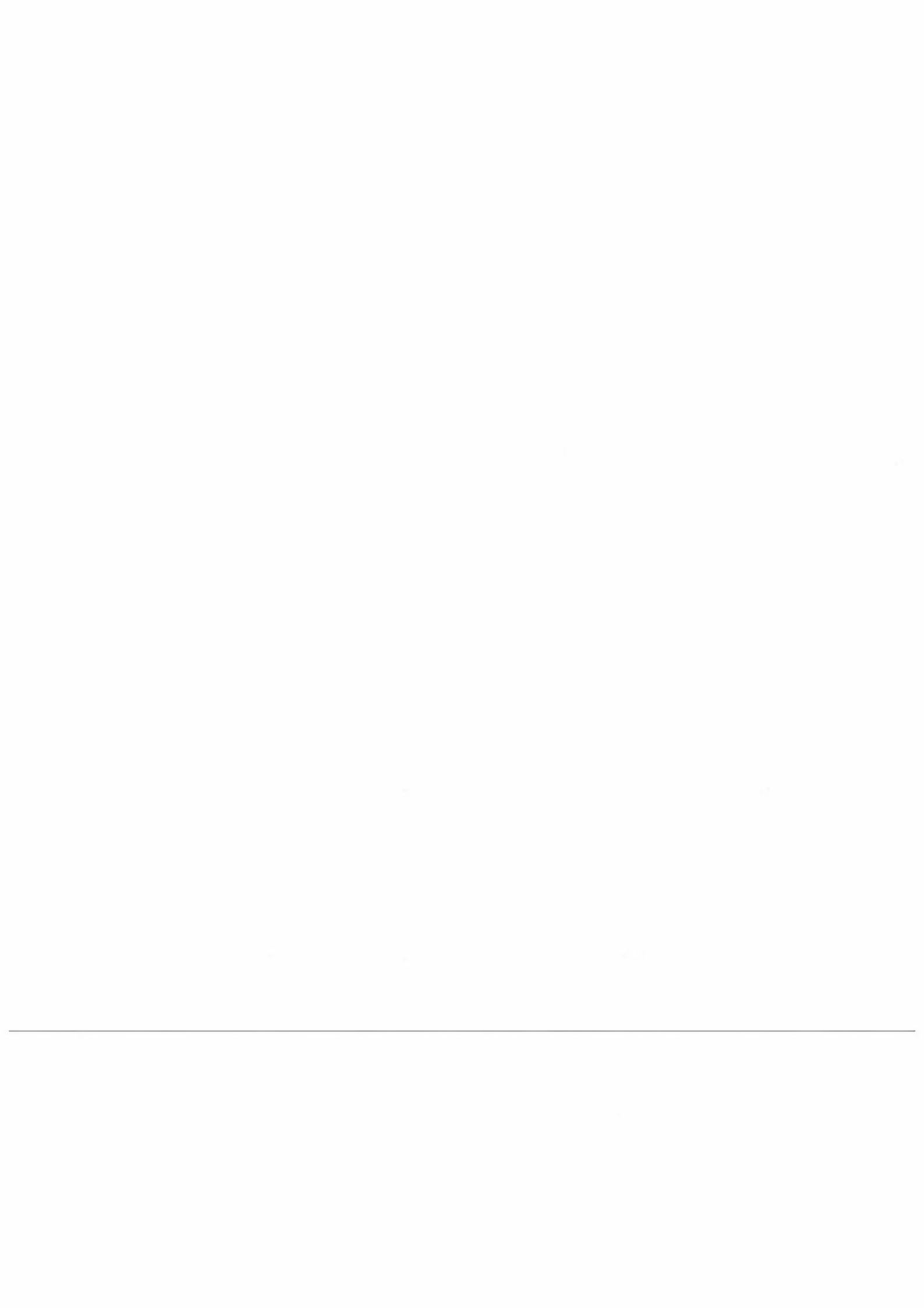

Bo Rendahl/V Kucera
Nov. 23, 1993

Experience from WETCORR monitoring on UN/ECE Stockholm South test site

EXPERIMENTAL

The exposure with the Wetcorr instrument has been performed at the ECE-test site Stockholm South, which is located on a flat roof on a seven floor building in the south center of Stockholm.

The Wetcorr sensors were mounted with Scotch double adhesive tape on zinc panels with the dimension 150x100x1 mm. On each panel duplicates of sensors were mounted. The sensors were exposed at different inclinations freely and with different degree of protection towards rain and environmental effects as follows:

Free exposure	10° inclination facing south
	45° inclination facing south
	90° inclination facing south
	90° inclination facing north
Sheltered	0° inclination
	90° inclination
Inside an Al box	90° inclination

The sensor voltage was chosen to 200 mV and measurements were made at every 15 minutes. The exposure started 930405 and will continue for 9 to 12 months. The setup of the exposure is shown in Figure 1.

RESULTS

In the beginning of the exposure and during the pre-exposure there were problems with 4 wetcorr-sensors with repeatedly high current levels. These 4 sensors were connected some weeks to the same adapter. After a while two of the sensors started to work satisfactory and the other two were replaced by new ones. For this reason the results presented here correspond to the period 930601 to 931117.

During the free exposure in 10° and 45° inclination facing south the time of wetness (TOW) at 20 nA level was about the same for all six sensors exposed. The differences between the measured exposure periods were also small, all values being between 20% and 30% TOW. Using the 10 nA wetness level there were higher TOW for the sensors

exposed with 10° inclination. The sensors exposed with 90° inclination facing south and north also show about the same TOW at the 20 nA level. With the 10nA level the TOW was much higher on the sensors facing north. The TOW was much higher in the autumn than during the summer. The reproducibility between the duplicates in the free exposure seems to be very good.

In sheltered conditions the variation between the duplicates is higher, especially in the beginning of the exposure. With 100 nA level one of the sensors gave 16% TOW while the other gave 0%. The sensors with 90° inclination have somewhat higher % TOW than with 0° inclination. The reason for this is probably that the used shelter consist of a large box without bottom and that the sensors with 90° inclination were mounted higher up in the box with less ventilation. In the beginning of the exposure the TOW was very low under the shelter but increased with the exposure time to 97% at the 20nA level.

Inside the aluminum box, with restricted ventilation, the TOW has been low during the whole exposure period.

DISCUSSION

As the exposure period is not yet finished the results obtained and conclusions which can be drawn so far should be considered as preliminary.

The **reproducibility** between cells exposed in parallel has been very good at free exposure, while at sheltered exposure the spread in results is greater. It should, however, be stressed that this may be due to a non uniform deposition of pollutants on the cell surface which is not equalized by precipitation as is the case at free exposure.

The value of the **wetness threshold level** is of principal interest and will affect the time of wetness measured by the technique. At open exposure there is only a small difference between the 10 and 20 nA levels, while at the 100 nA level the time of wetness was much shorter. The wetness measured and calculated according to ISO (time with RH >80% and T>0°C) shows the same pattern as the Wetcorr values but the ISO values are usually higher even than at the 10 nA level.

The **length of the exposure period** for standardized measurements is so far not easy to recommend. At free exposure no visible signs of deterioration were observed. At sheltered exposure, however, the current level and thus the time of wetness gradually increases which is obviously connected to deposition of pollutants at the cell surface.

The **frequency of measurements** has been 15 minutes which gives a great amount of data. It should be of interest to compare the so achieved values of time of wetness with values obtained from less frequent measurements.

The **measurement of temperature** seems to give very reproducible values. They show i.a. that the shelter strongly suppresses the temperature variations compared to open exposure.

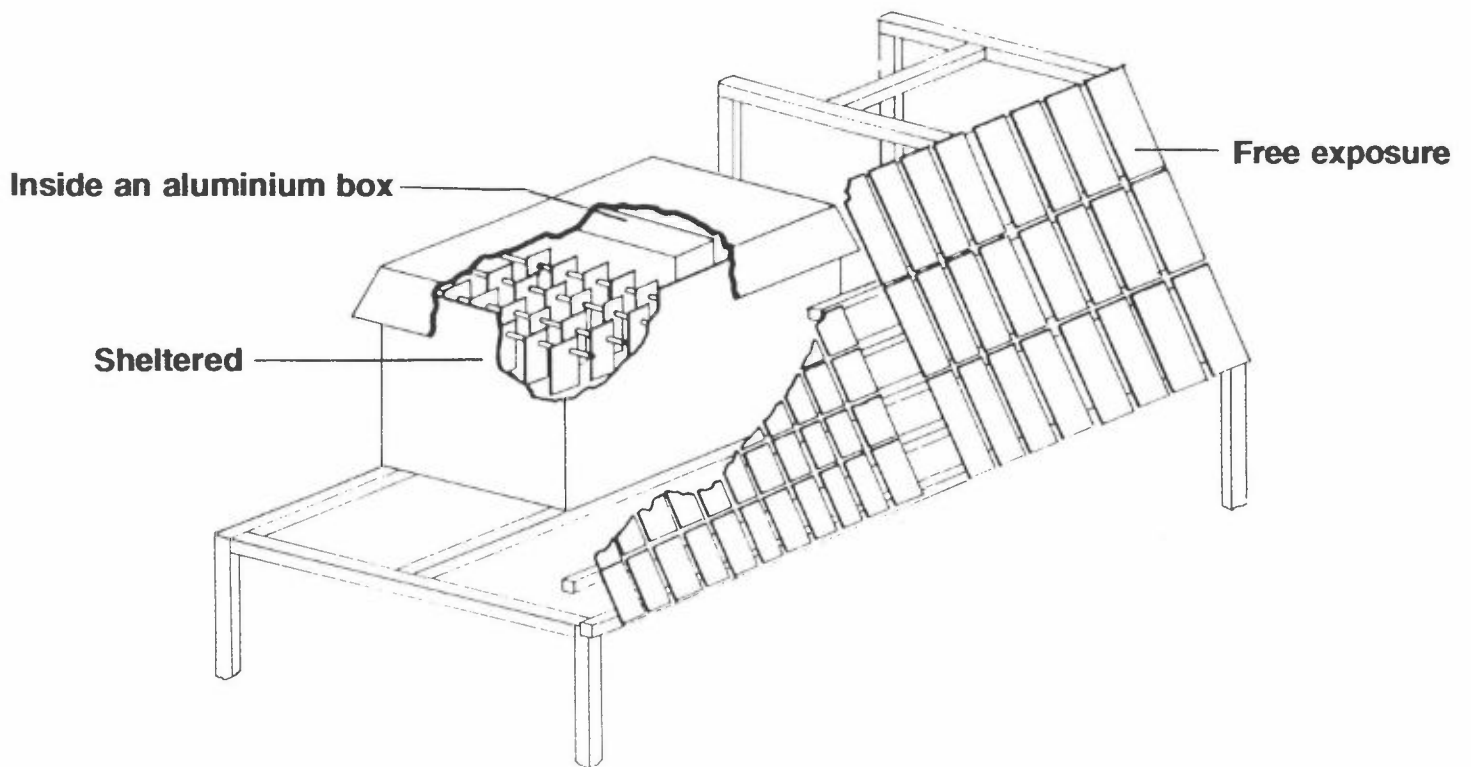

FIGURE 1. Exposure on the ECE Stockholm South test site.

Time of wetness (TOW) in % with 10 nA

	1/6-30/6	1/7-31/7	1/8-31/8	14/9-15/10	16/10-17/11
Free 10° south	23	55	72	59	57
	25	49	66	59	52
Free 45° south	21	19	28	34	28
	20	18	29	37	23
	20	22	26	30	26
	22	20	26	28	22
Free 90° south	10	14	17	42	48
	10	13	18	24	41
Free 90° north	13	48	90	76	81
	13	49	94	74	79
Sheltered 90°	38	57	92	96	99
	24	42	85	94	98
Sheltered 0°	15	36	63	83	97
	18	17	62	80	97
AI - box	1	11	16	15	21
	-	0	2	0	42

Time of wetness (TOW) in % with 20 nA

	1/6-30/6	1/7-31/7	1/8-31/8	14/9-15/10	16/10-17/11
Free 10° south	20	19	24	22	24
	21	19	24	22	23
Free 45° south	19	16	23	30	24
	17	15	24	28	21
	16	18	22	21	21
	18	17	21	22	20
Free 90° south	8	8	12	19	36
	8	9	14	21	35
Free 90° north	7	6	19	26	22
	8	6	22	19	35
Sheltered 90°	24	45	88	94	99
	10	29	79	90	97
Sheltered 0°	8	30	58	78	96
	16	9	57	71	96
AI - box	0	0	0	0	0
	-	0	2	0	28

Time of wetness (TOW) in % with 100 nA

	1/6-30/6	1/7-31/7	1/8-31/8	14/9-15/10	16/10-17/11
Free 10° south	4	8	16	11	18
	3	6	5	7	13
Free 45° south	1	3	2	11	11
	1	2	7	12	13
	0	2	2	7	10
	1	2	4	8	12
Free 90° south	0	1	2	5	11
	0	1	2	8	5
Free 90° north	0	2	1	9	6
	0	1	1	10	24
Sheltered 90°	0	16	69	86	94
	0	0	46	72	87
Sheltered 0°	0	6	37	58	88
	14	0	36	50	84
AI - box	0	0	0	0	0
	-	0	0	0	0

Time of wetness (%) measured by the WETCORR instrument at 45° inclination facing south, free exposure and using the ISO method (RH>80%, T>0°C).

Method, treshold level	Time of wetness, %			
	June	July	August	
WETCORR	10 nA	21	20	27
	20 nA	18	17	23
	100 nA	1	2	4
ISO	22	32	44	

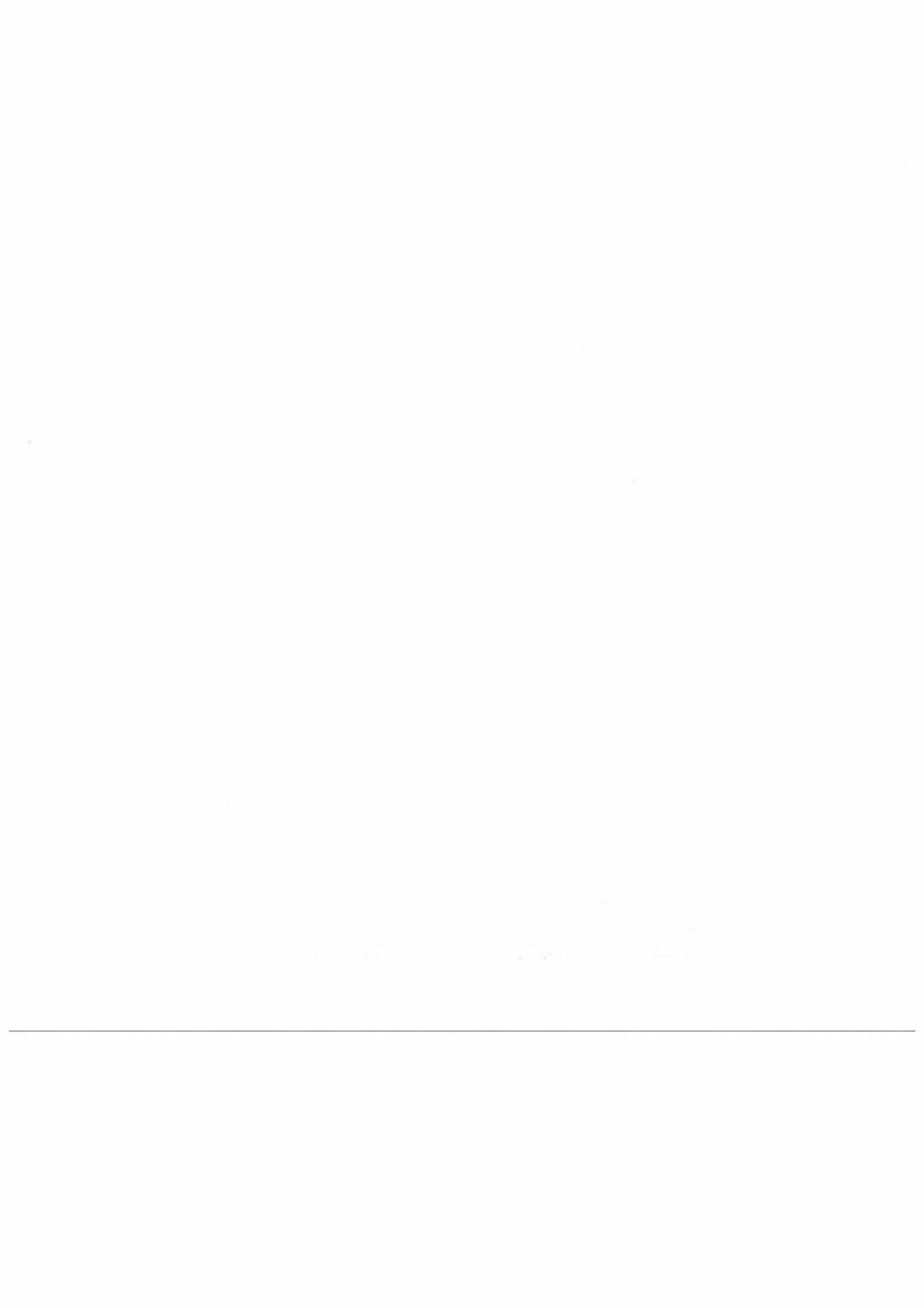

Appendix H

Use of WETCORR instrument on an artificial facade

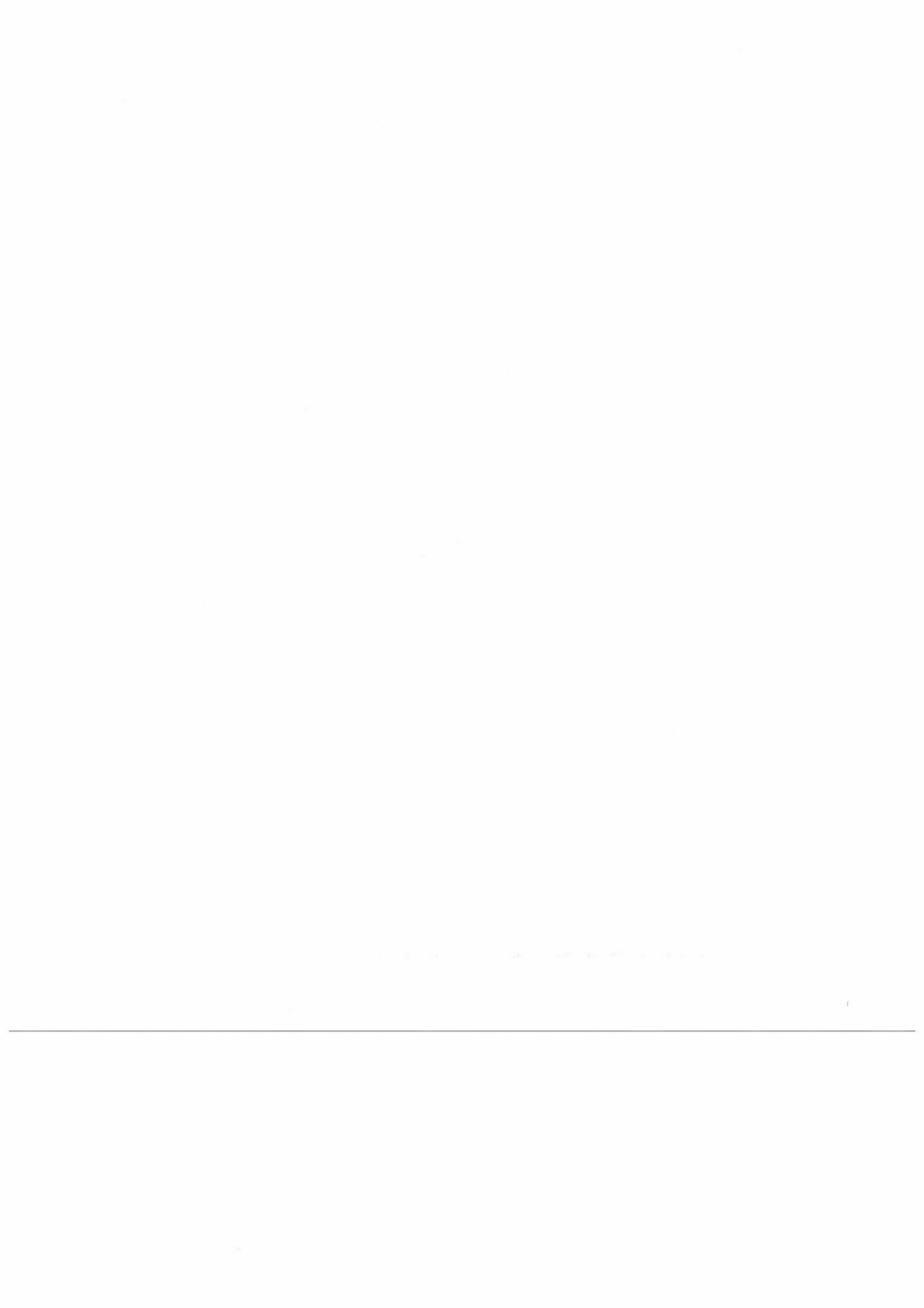

USE OF WETCORR ON AN ARTIFICIAL FACADE

P.F. O' Brien, T.P. Cooper, Trinity College, Dublin, Ireland

1 Introduction

The time of wetness is increasingly believed to be an important determinant of the rate and mechanism of decay of stone. The sulphation of stone proceeds at a much greater rate when the stone is wet as opposed to the dry state. The effects of wetness appear to be accelerated where washing of the surface is absent. Well washed surfaces are generally observed to be in good condition due to the washing away of the products of sulphation and other damaging salts. Arising from this understanding, the WETCORR device was designed to measure and record the time of wetness on stone surfaces.

The device has been described in detail elsewhere [1]. The WETCORR device was tested at Trinity College Dublin (TCD) as part of the European wide STEP programme on the scientific understanding of the decay of historic buildings and monuments [2] The device was tested outdoors at a specially constructed artificial stone facade. The results of this work is described in this report.

2 Outdoor exposure

The WETCORR device was used to collect time of wetness data on a specially designed artificial facade. The facade was designed to study the stone decay processes occurring in different microenvironments on a facade. It is recognised that different parts of a facade deteriorate very differently, due to differences in washing regime wetting and other microenvironmental parameters.

The artificial facade mimics a number of microenvironments. A projecting overhang with sides protects the lower area from direct washing. Five microenvironments are included in the facade. The first is located at the top of the facade and is well washed. The second microenvironment is fully protected by the overhang and would only be wetted under severe conditions by wind blown rain. The third microenvironment is situated below this and receives considerably more rain and runoff but is protected to some extent by the overhang. Microenvironments 4 and 5 are similar and are well washed but would have some variation over their vertical length.

The microenvironments have small disks of stone inserted flush with the surface which are sampled to measure the effects of the different microenvironments. The artificial facade was constructed of Portland limestone.

The WETCORR cells have been attached as set out in figure 1. Cell 1 is above microenvironment 1 while cell 2 is below. Cell 2 is located close to the projection. Cell three is located underneath the overhang facing downwards. Cell 4 and 5 are above and below microenvironment 3. All cells were conditioned with rainwater in advance

of exposure. Monitoring is ongoing at the site. A data set of 7 days was produced to assess the WETCORR unit.

4 Results of outdoor exposure

Representative data from the 6 cells has been graphed to compare the current output from the different microenvironments. These are compared in groups of adjacent cells. Cells 1, 2, 3 and 6 are located at the top of the facade. Current from cells 1 and 2 gave similar diurnal trends in current. Current and temperature are plotted in figure 2. Cell 2 close to the projection recorded a slightly higher current. Values ranged from 40 nA to 500 nA for cell 1 and between 50 to 100 nA for cell 2. Current from cell 2 was higher indicating a greater time of wetness. The fluctuations of cell 2 was more dramatic than cell 1 giving greater high and low current output under the same environmental conditions. A previous recording period gave a similar result but the differences were not so pronounced in the data set reported in this document.

Cell 3 on the horizontal surface underneath the projecting stone gave an appreciably lower current than cell 1. This is as expected, given its sheltered position. Current values ranged from 30 nA to 200 nA for cell 3. Fluctuations in the current were smaller in cell 3 than cell 1, again reflecting the influence of the surrounding stone canopy. Data from cell three is plotted in figure 3.

Cell 5 (below microenvironment 3) recorded a higher current level than cell 4 (above microenvironment 3). This was especially noticeable toward the end of the data period. Cell 4 current ranged from 30 nA to 200 nA. Cell 5 range was 30 nA to 1000 nA. The greater current in cell 5 could be due its proximity to the bottom of the facade where it could be influenced by the horizontal surface the facade is placed on, or due to its greater distance from the projecting stone canopy.

Cell 2 and cell 6 are located close together but are on planes which are at right angles to each other. Cell 6 is on a horizontal surface facing upward while cell 2 is on a vertical surface. Data from cell 6 is plotted in figure 3. The current fluctuations are much greater in cell 6 with greater high and low current values being recorded for a given set of environmental conditions. The average current value is probably similar as the periods when cell 6 current is greater are balanced by periods when cell 2 is greater. The orientation of cell 6 upward to the sky produces a very different microclimate where the effects of radiatant heating and cooling are more pronounced. This data could be more fully interpreted if weather data was available. Weather monitoring at the site is being carried out but equipment malfunction prevented the data being used in this analysis.

Temperature measurements from all sensors are very similar. The one exception was the sensor on cell 6 which was about 5 degrees lower than the rest. This is thought to be a sensor problem.

Discussion

The data set from the WETCORR instrument analysed agrees well with the expected moisture regime from the different microenvironments. Microenvironment 1 is the

most exposed. The closeness of the projection has a pronounced effect on the bottom of this microenvironment as measured by cell 2. A similar effect may explain the high current levels in cell 5 at the bottom of microenvironment 3. The effect of increased salt loading on sensors lower down could also produce higher currents. The effect of salt loading on the magnitude of current has been demonstrated [1]. Runoff from above could deposit extra salt on sensors lower down.

The effect of orientation on time of wetness was very pronounced. The effect of the canopy on the microenvironment was demonstrated by the data from cells 3 and 6. As well as a much lower overall current level underneath (80 versus 200 nA) the fluctuations in response to environmental conditions were very much greater. The diurnal trends in current closely follow expected relative humidity cycles. Increased relative humidity at night when temperatures are low with lower relative humidity during the day when temperatures are higher.

The cells attached to the different microenvironments will develop a layer of salts which reflect the conditions where it is exposed. The cell current will respond to changes in the moisture regime of this surface layer. Thus the sensors should respond in a similar fashion to the stone surface layer. To the extent that the cell surface mimics the stone surface it will give an accurate representation of the surface moisture conditions. The work presented here demonstrates the ability of the device to detect differences in microenvironmental conditions over small areas. Given that the moisture regime is an important determinant of the rate and mechanism of stone decay the WETCORR device should prove useful. It is being used on an ongoing basis in the research programme at TCD. Further work needs to address how closely the cell surface layer mimics the stone surface environment.

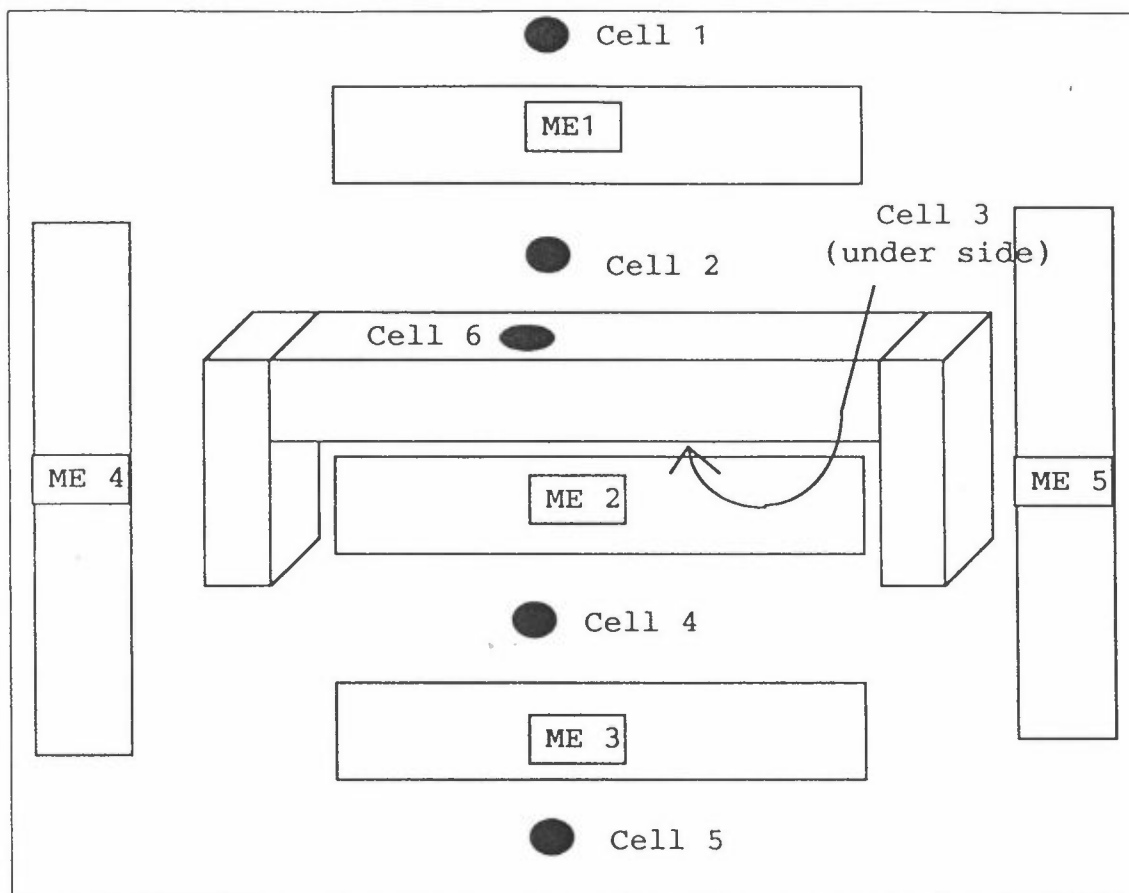

Figure 1 location of WETCORR measuring cells and microenvironments on the artificial facade

Acknowledgements

This work was supported by the European Commission under the STEP research programme, contract number STEP CT90-0107-SSMA.

References

- [1] Henriksen J.F, Haagenrud S.E., Store, M 1993
Monitoring of the wetness impact on buildings by means of a new instrument for continuous recording (EUREKA EU 615 EURO CARE WETCORR).
UNESCO/RILEM Congress on the Conservation of stone and other materials.
Paris, 29 June-1 July 1993
- [2] Conservation of historic buildings, monuments and associated cultural property.
Contract no. STEP CT90-0107-SSMA.

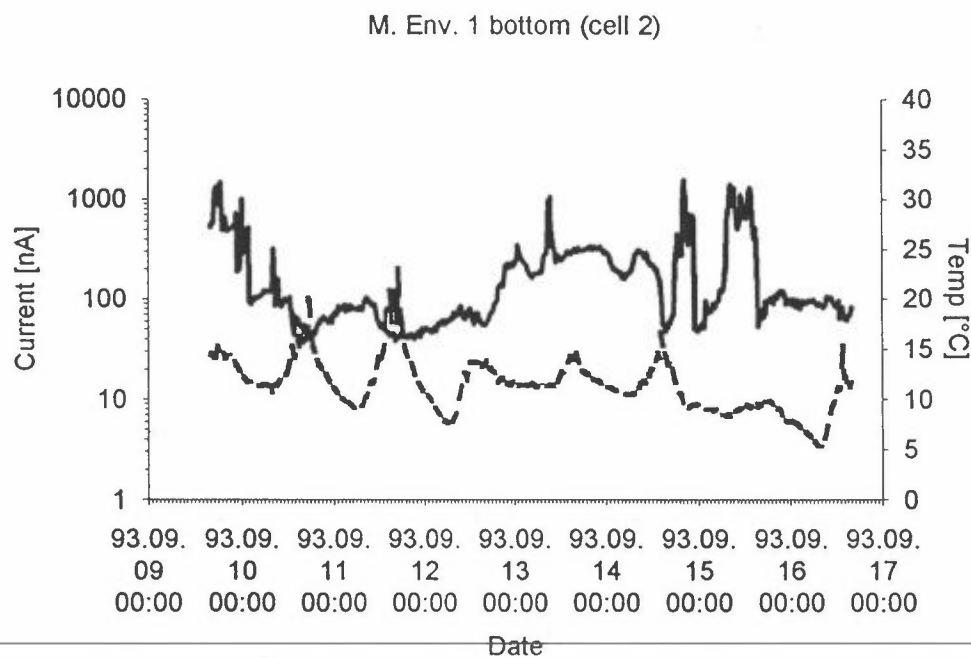
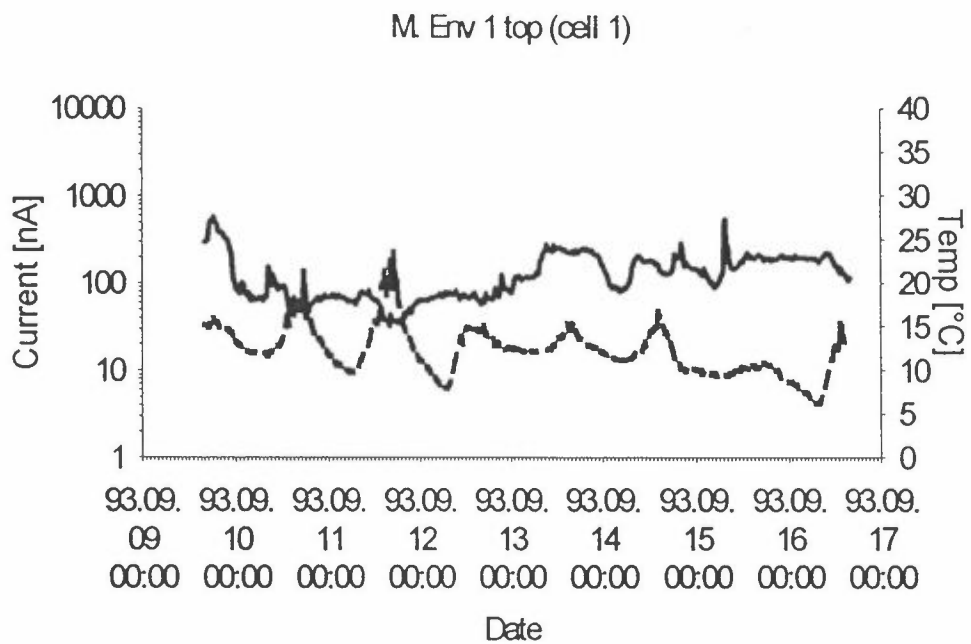

Figure 2 Current and temperature from cells 1 and 2 . Dashed line is temperature.

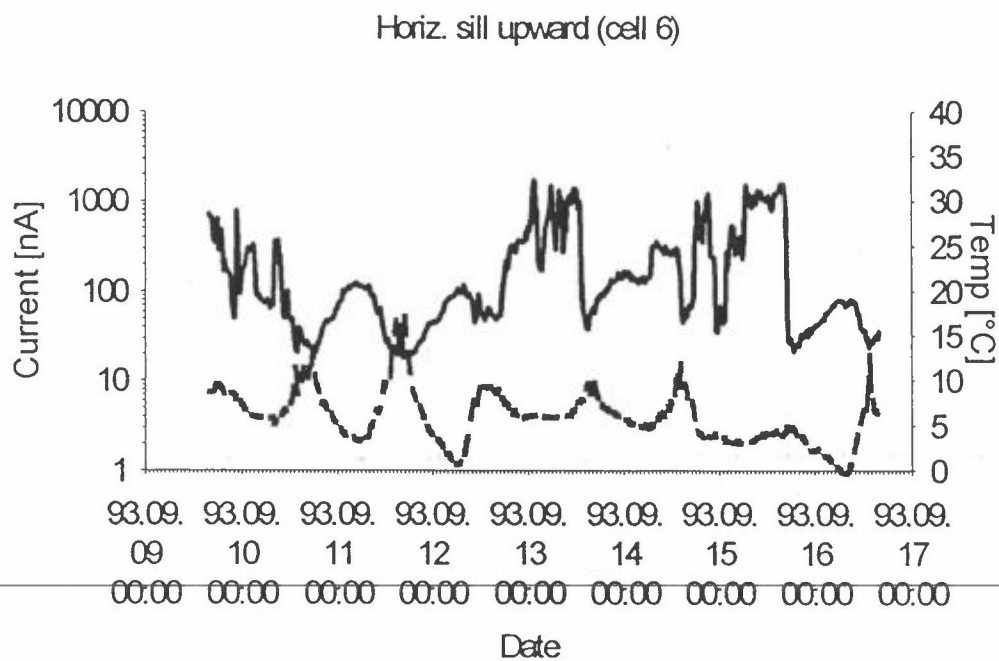
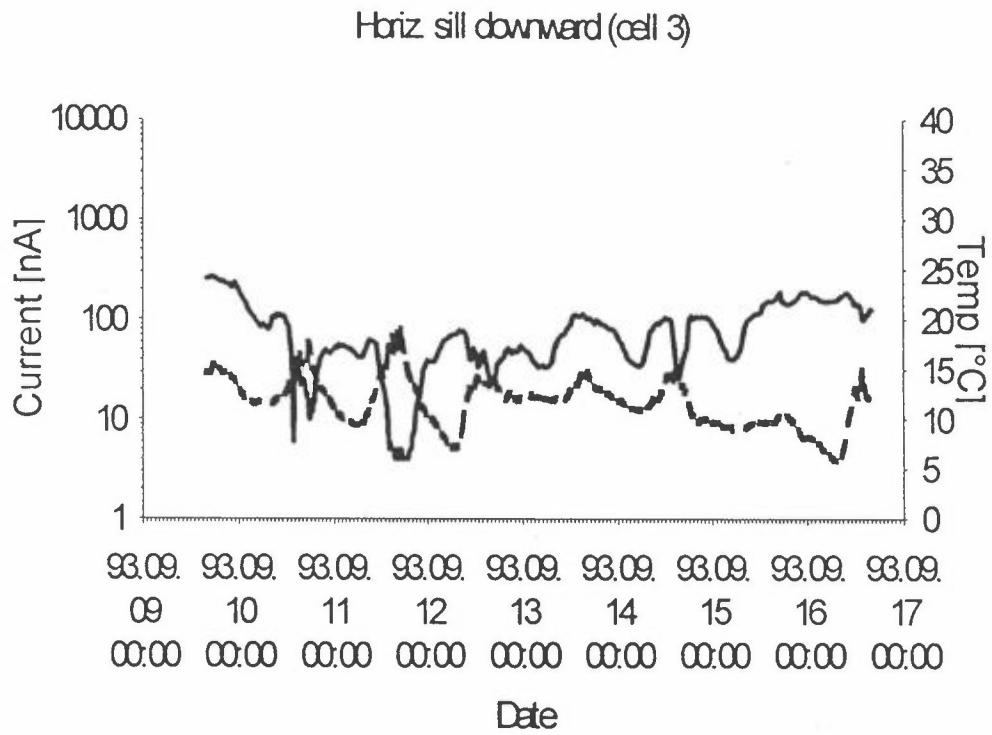

Figure 3 Current and temperature from cells 3 and 6.

Appendix I

Use of WETCORR instrument at NILU's laboratory

NILU laboratory

The conclusions drawn in chapter 8.5 are illustrated by the following figures:

Figure I.1 shows the increased current flow in a sensor applied in sheltered position compared to a sensor openly exposed on the same wall.

Figures I.2 and I.3 show the importance of measuring the time of wetness with sensors in the micro environment instead of calculating the TOW from meteorological parameters.

Figure I.4 shows that fairly little change in the time of wetness is recorded by changing the threshold values inside the dynamic range of the current flow for the sensors.

Figures I.5 and I.6 show that a temperature drop below 0°C causes an increased current flow in the gold sensor.

Figure I.7 shows the current flow in wood panel structures when the capillarity forces cause absorption of water into the structure.

Figure I.8 shows that aerosol deposition create an increased current at vertical placed sensors compared to 45° angle at the same time.

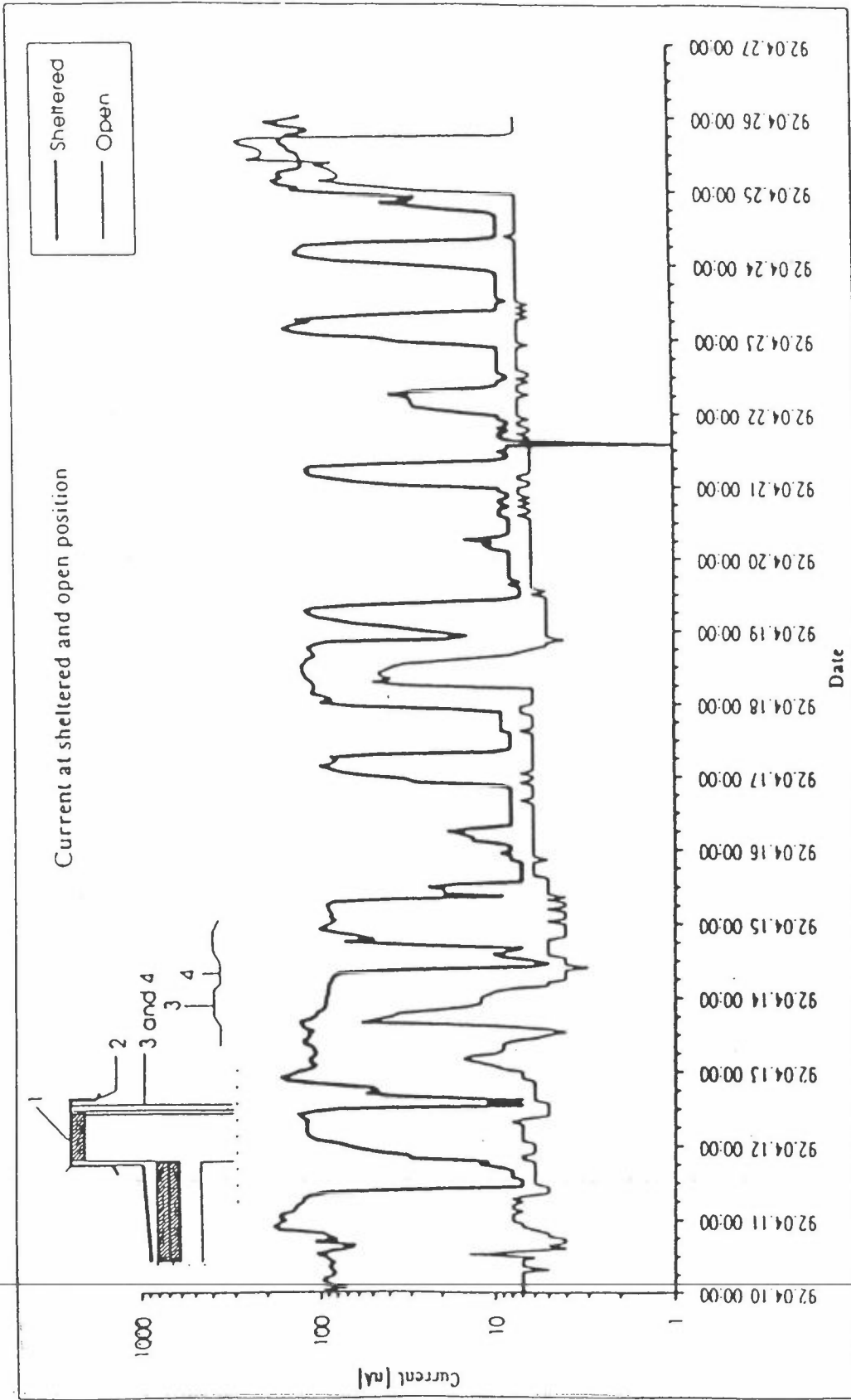

Figure I.1: The current flow at sheltered and open position at a facade.

Site 0013 0013SA02.
 Eksponering av celler på tak, plassert i 45

Date
 From: 92.04.01 00:00
 To: 92.04.14 23:00
 Printed: 92.09.29 12:29



Threshold
 Measured: 20 nA 53,0%
 Calculated: 51,0%

RingSys ILAB NILU

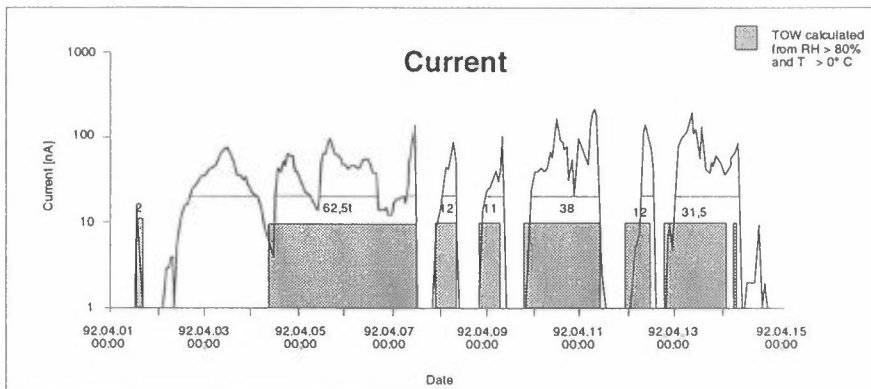

Site 0013 0013SA02. Eksponering av celler på tak, plassert i 45

Date
 From: 92.04.15 00:00
 To: 92.04.28 23:00
 Printed: 92.09.29 12:30

RingSys ILAB NILU

Threshold
 Målt: 20 nA 20,2%
 Beregnet: 28,0%

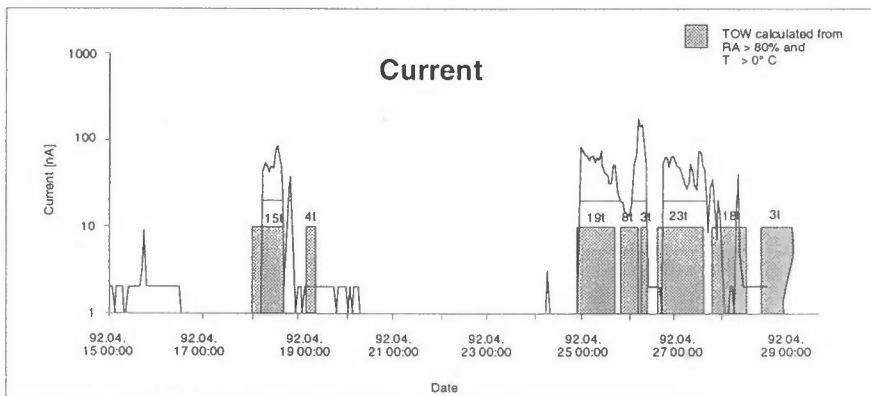

Site 0013 0013SA02. Eksponering av celler på tak, plassert i 45

Date
 From: 92.04.29 00:00
 To: 92.05.12 13:00
 Printed: 92.09.29 12:31

RingSys ILAB NILU

Threshold
 Målt: 20 nA 18,4%
 Beregnet: 33,0%

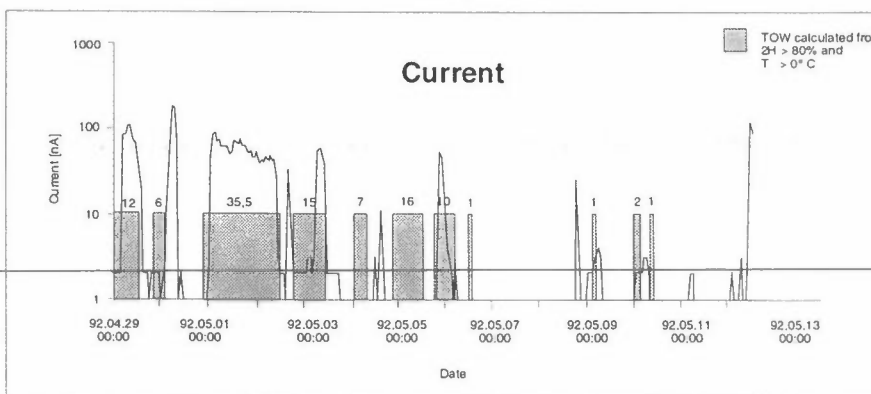

Figure I.2: Calculated and measured TOW for three 14-days periods in spring 1992.

Sammenligninger mellom ToW målt med Wetcorr og ToW beregnet ut fra ISO-krit. RF>80% og T>0°C

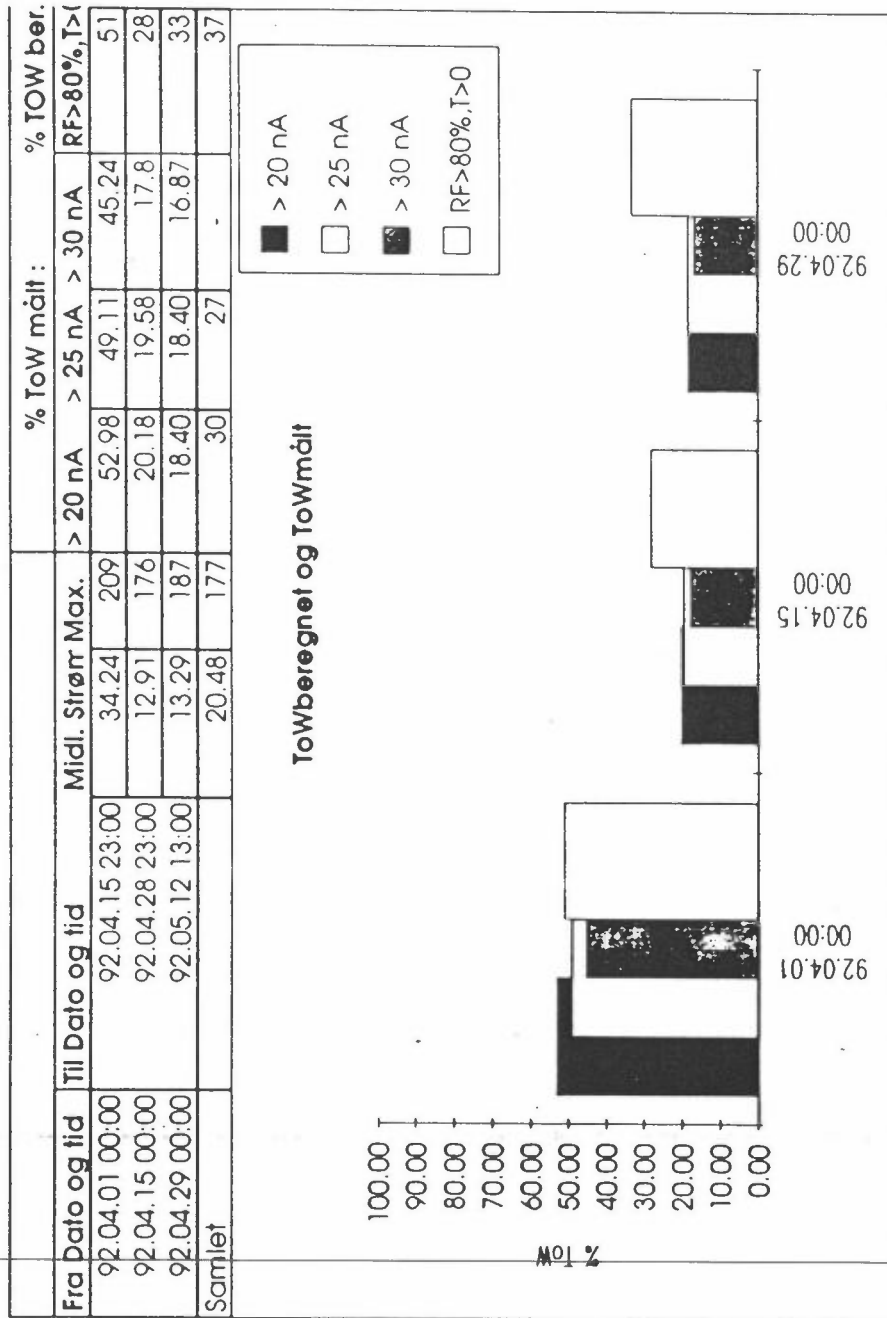

Figure I.3: Calculated and measured TOW for different threshold values.

Site: 0014 0014SA01. Forsøk 92Mars Eksponering av celler på tak, plassert i 45

Date
From: 92.03.03 00:00
To: 92.03.31 07:00
Printed: 92.12.09 02:34

Threshold	% ToW
20 nA	45.1
25 nA	43.7
30 nA	40.6

RingSys ILAB NILU

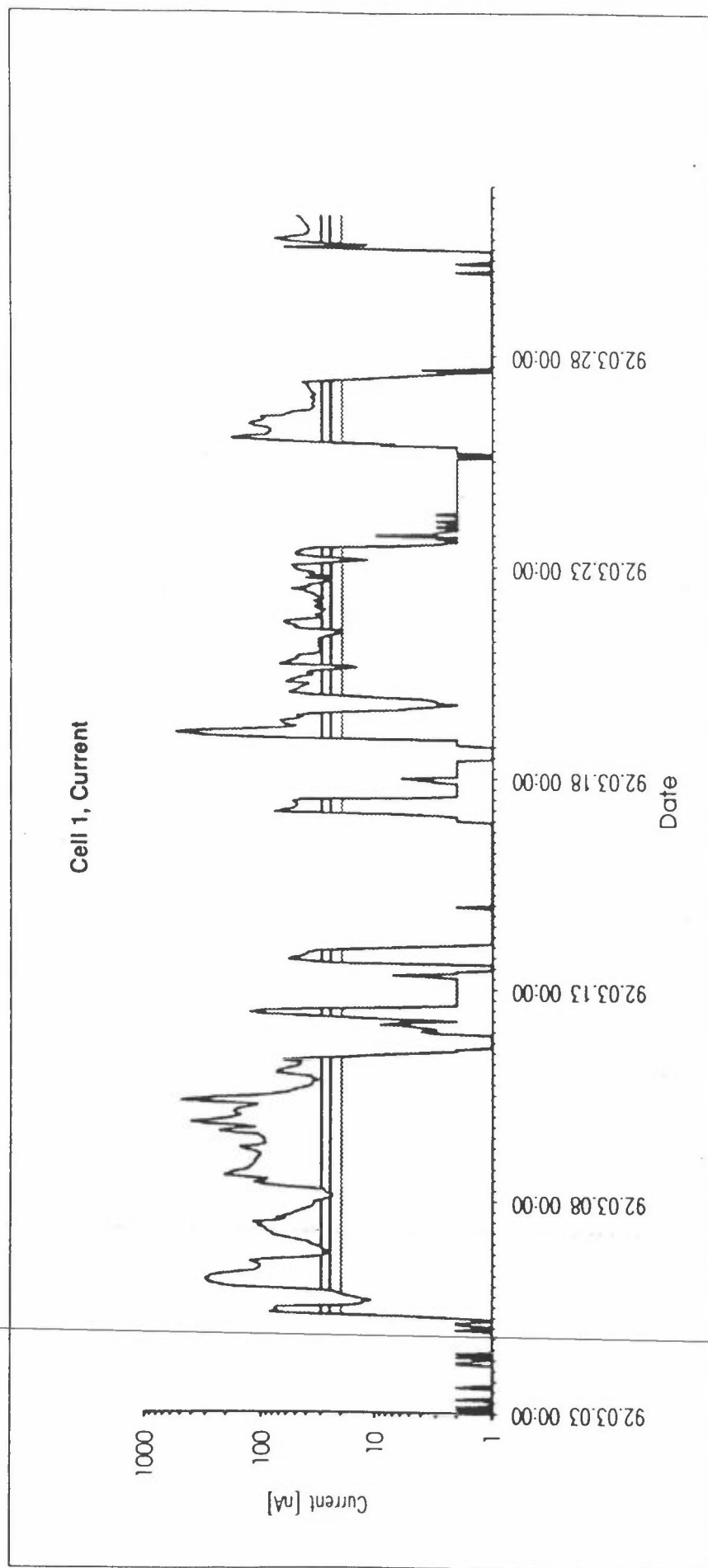

Figure I.4: Measured time of wetness at 20, 25 and 30 nA threshold values for a sensor exposed 45° through the south.

Date
 From: 92.01.08 15:00
 To: 92.01.31 11:00
 Printed: 92.09.29 16:17

Threshold 20 nA
 % ToW 42.0

RingSys ILAB NILU

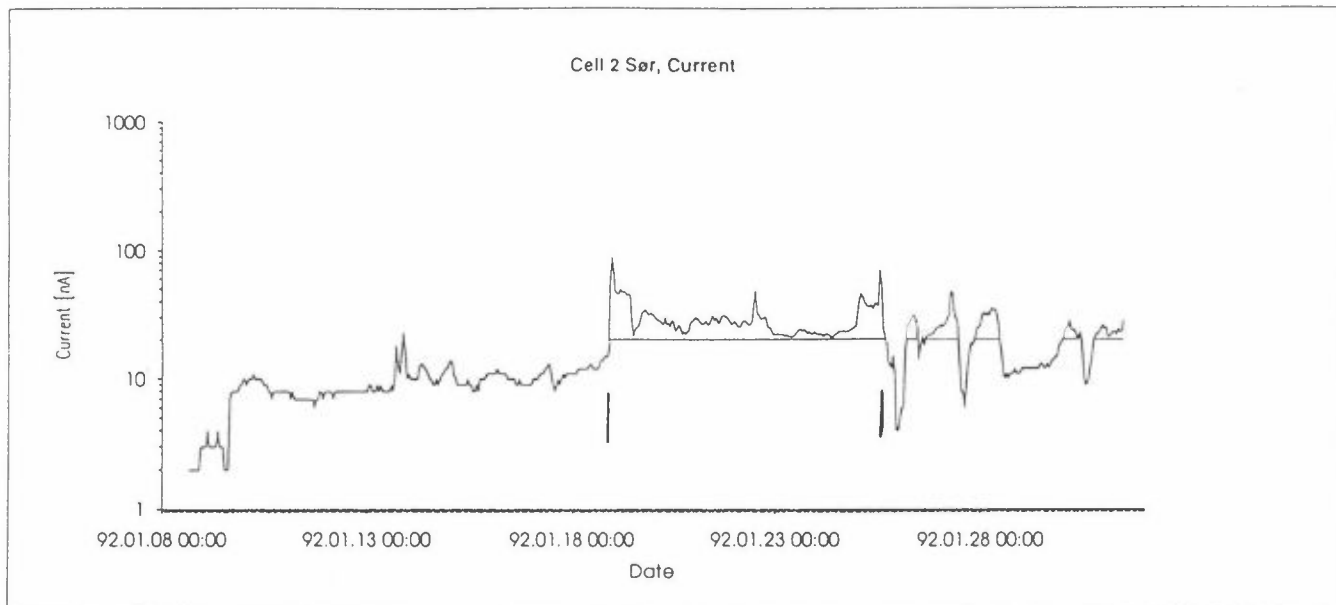

Figure I.5: Current flow on a gold sensor during a cold period in January 1992.

Site: 0014 0014SA04. Database file: 0014 er viftehuset på NILUs taklab. Celler er plassert oppe og nede. 0014SA01 VEST, 0014SA02 NORD..

Date
 From: 92.01.08 15:00
 To: 92.01.31 11:00
 Printed: 92.09.29 16:19

Threshold 20°C
 % 42.0

RingSys ILAB NILU

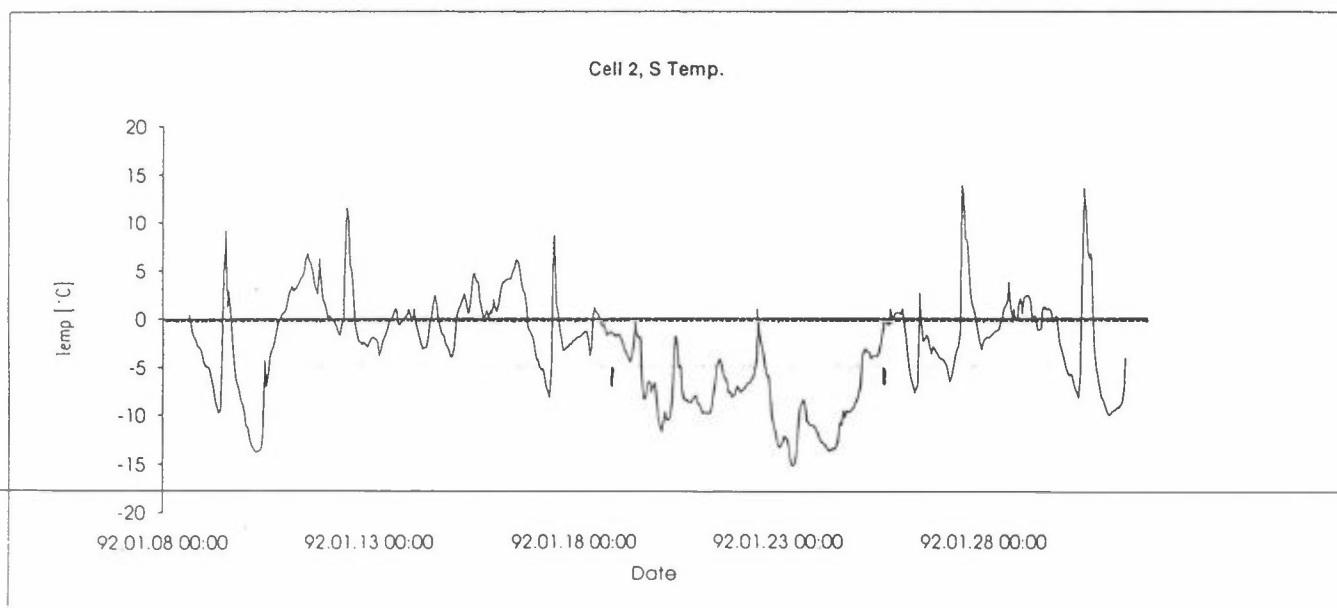

Figure I.6: The temperatures during the period in January 1992 where the current is shown in Figure I.5.

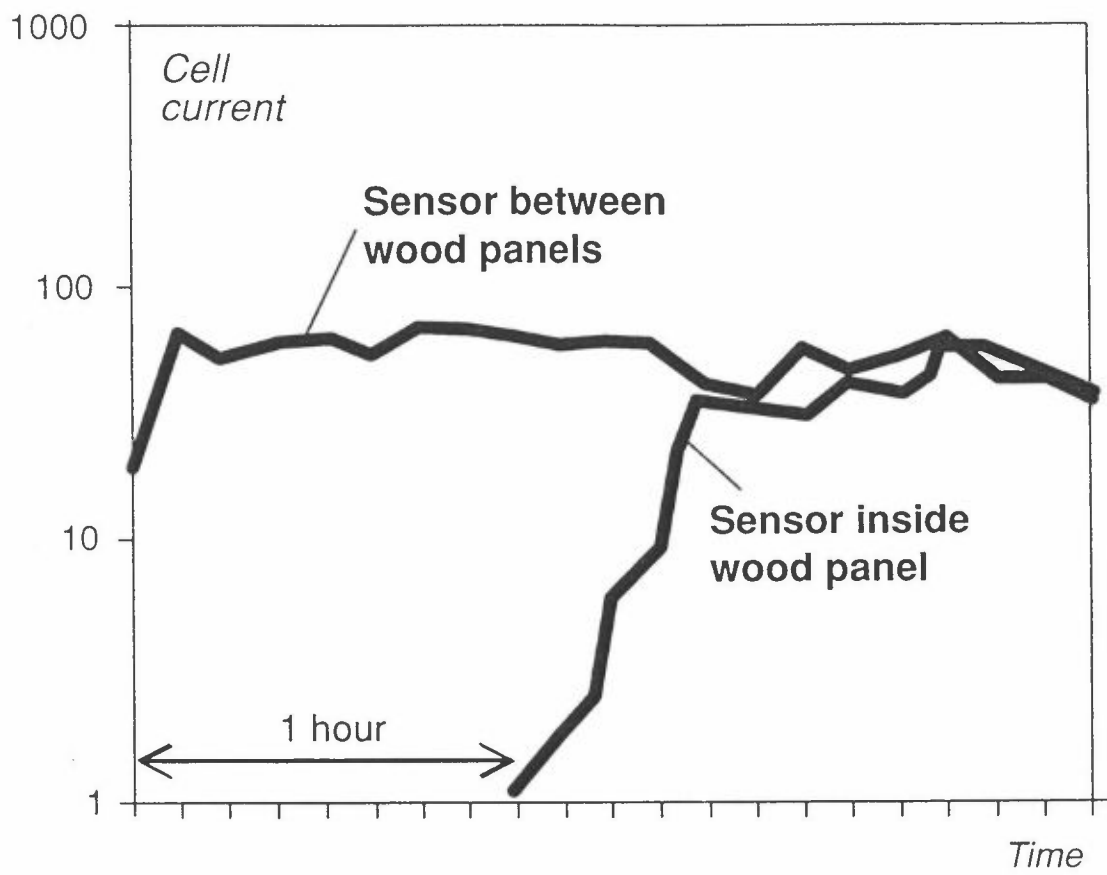

Figure I.7: TOW results from demonstration model of water uptake in wood.

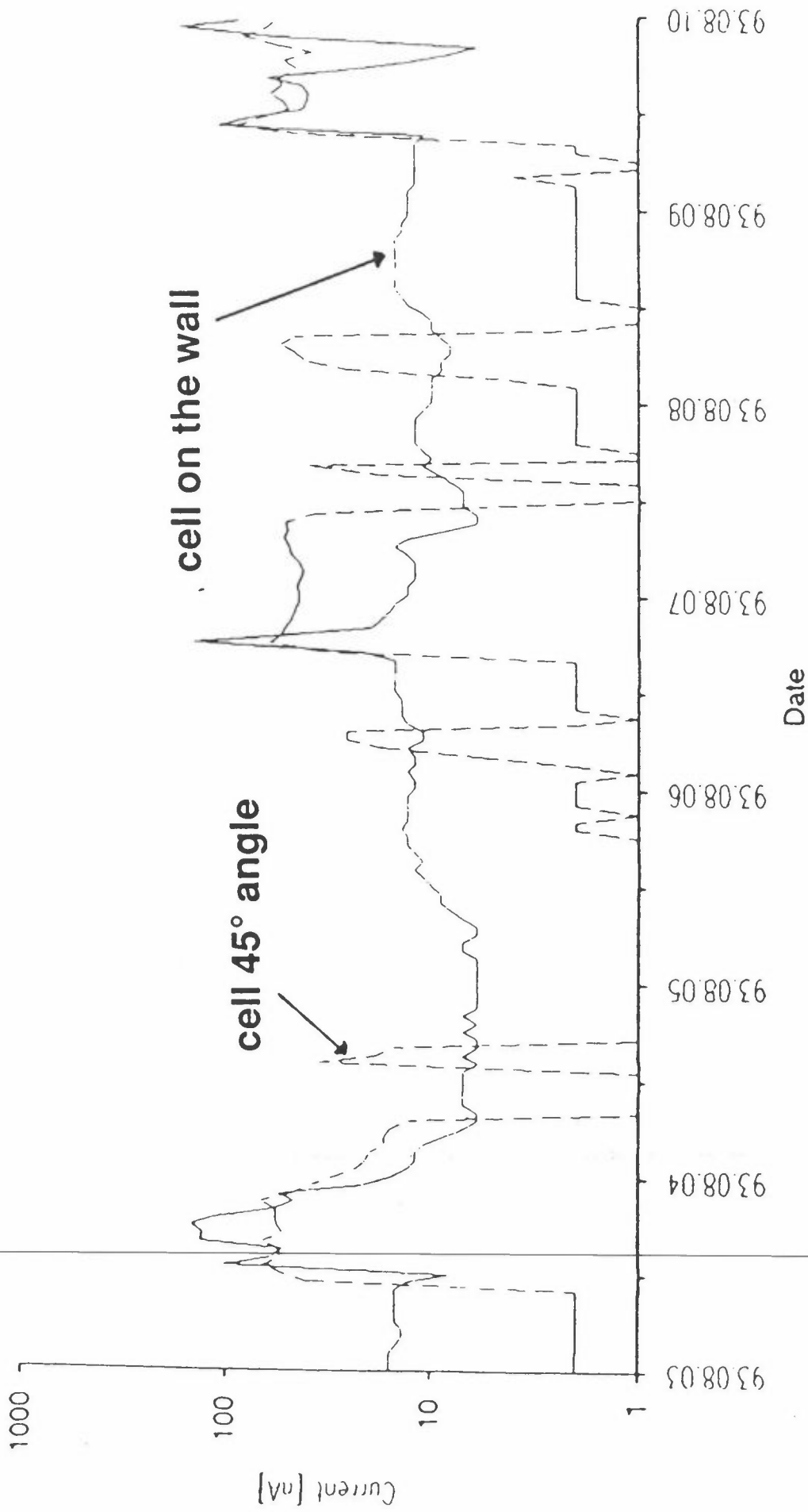

Figure I.8: NILU roof laboratorium. The effect of aerosol deposition on vertical surfaces compared to the cleaning effect of rain on cells 45° angle to the south.

Appendix J

Monitoring of time of wetness on concrete slabs

THE UNIVERSITY OF CHICAGO PRESS

NBS-MK Seminar
The WETCORR instrument for monitoring of time of wetness (TOW) and temperature
Oslo, 24 November 1993

MONITORING OF TIME OF WETNESS ON CONCRETE SLABS

Ernst Jan de Place
Materials and Structures Division
Danish Building Research Institute (SBI), Hørsholm, Denmark

Summary of tests performed

The WETCORR-instrument is used for measuring time of wetness (TOW) and temperature on 50 by 200 by 500 mm concrete slabs exposed outdoors on a flat roof at the Danish Building Research Institute. The slabs are placed at a 45° angle and are facing south (see figure 1). A total of 6 sensors are fastened with silicone to the surface of the concrete slabs, which are made without air-entrainment and with a water-cement-ratio of 0.30, 0.45 and 0.70 respectively. Measurements have been going on since November 1992.

The measurements are carried out as part of a PhD-project on frost resistance of building materials which also involves laboratory tests. The frost resistance of the concrete is tested according to the Swedish Standard SS 13 72 44 "Concrete testing - Hardened concrete - Frost resistance" by measuring the weight of scaled material per freeze-thaw cycle. The critical degree of saturation - i.e. the saturation below which frost problems will not occur - as well as the pore structure are studied. The purpose of the outdoor exposure is to determine the moisture characteristics of concrete under real conditions (how long is the concrete wet ? - how often ? - how great is the risk of damages related to frost ? - etc). The WETCORR measurements are correlated with climate data: rainfall in mm/h, sunshine in min/h, air temperature and relative humidity. As a measure for sunshine is used radiation in excess of 200 W/m².

In the summer of 1993 the Danish Building Research Institute participated in a calibration test of the WETCORR sensors (as presented by Jan F. Henriksen, NILU at this seminar). 8 sensors were fastened to an aluminium plate with double-coated adhesive tape normally used for carpets. The plate was placed on the same roof as the concrete slabs with the same slope and orientation. These measurements took place from 8th July to 20th Sept. Finally the plate was moved to a climate chamber where the sensors were exposed to varying RH as prescribed by NILU.

Evaluations, conclusions and recommendations for the WETCORR instrument

The reproducibility of the sensors seems OK, although they do not seem to respond at exactly the same time and do not reach quite the same level when wet. During wet periods the maximum response can go as high as 600-800 nA (in the summer somewhat lower). The ultimate high response measured is 11317 nA in March 1993, half an hour later the same sensor showed 64 nA. The sensors show a minimum response of about 15-20 nA, also during long dry periods, a little lower in summer than in winter. There seems to be a reasonable correspondence between the TOW, and a combination of the RH, the amount of sunshine and the temperature. However, the results indicate that a rainy month (July 1993 gave 110 mm) does not necessarily give a high TOW, and vice versa a dry month (February 1993 gave 29 mm) might give a high TOW. See also table 1.

The outdoor exposure showed good correlation between the new sensors (used in the calibration test) and the sensors placed in Nov 1992. Only the first 4 days gave very low response (3-5 nA) in the new sensors. In the climate chamber, however, the response of the sensors was almost unaffected by the

changes in RH used for this test. Only when spraying with artificially made rainwater a clear response is seen.

No difference in temperature was measured between the sensors fastened to the aluminium plate and the sensors fastened to the concrete slabs. In contrast to the major part of measurements the sensors fastened to the concrete slabs are oriented in such a way that it is possible for water to run along the wire and down to the sensor (see figure 2). This was done to avoid problems with water inside the wire. In the calibration test the sensors were oriented with the wire downwards. There does not seem to be any dependency of this difference in orientation, as the sensors fastened to the slabs and to the aluminium plate responded quite similarly during the summer, when the calibration test took place.

We do not have experience with the behaviour of the sensors during periods with frost and/or snow.

The sensors on the slabs do not show any sign of deterioration after an exposure of one year.

We have some proposals for improving the reliability of the sensors. It is assumed that each WetCorr sensor can be described as a discrete component which only has electrical connection to the sensor adapter. However, it is shown that the WetCorr sensor sometimes has electrical connection to the temperature sensor. At high RH a leakage to the surroundings will exist. By changing the pattern of the electrodes on the WetCorr sensor these problems should be minimized (see figure 3). In order to improve the reliability of the temperature measurements we suggest to use a gold resistor applied in the same way as the pattern of the WetCorr sensor (see figure 3) and protected with a moisture-proof layer. The temperature sensor should be placed outside the "guard" of the WetCorr sensor as shown on figure 3. Considering all the possible sources of error when measuring temperature a 1-point calibration of the temperature sensor seems adequate. To minimize electrical interaction between the WetCorr sensors the excitation to the sensors should be pulsed instead of continuous. The mounting of the sensors to the construction should be better specified.

The controller and the adapters have performed without any problems. In October 1993 the power supply unit to the system controller was attacked by mice and was replaced. Nevertheless the system controller still held data for 2 weeks of the period since the latest unstore (data are unstored once a month).

An updated version of the software was received in April 1993. After installation and necessary adjustments the software has been running without any problems. The automated processing of data and printout is working but has not been used. It would be an advantage if during the automated processing of data it was possible to examine the data in more detail and possible to see a graph and adjust the thresholds before printing it out.

It is proposed to supplement the statistic module with a feature to determine the frequency of TOW and the longest period above a specified threshold.

As mentioned the purpose of the outdoor exposure in this project is to determine the moisture characteristics, primarily the moisture content. The WETCORR measurements can be used for this by selecting suitable thresholds defining wet cells and take into regard the fact that it takes some time for ~~a moisture-film to build up and break down respectively on the surface of a porous material such as~~ concrete. Based on field tests on concrete facades facing north and east respectively, Svennerstedt¹ concluded that the TOW will not change noticeable when these facts were taken into account.

To calculate the moisture content the results must be combined e.g. with determination of diffusion coefficients and a pore size distribution and a mathematical model for correlating the amount of surface

¹ Svennerstedt B.: Surface moisture on facade materials. TN:16, The National Swedish Institute for Building Research, Gävle, Sweden, 1989. (in Swedish).

moisture and the moisture content in the material must be developed. This illustrates that there still is some work to be done before we can determine the moisture content in porous materials by means of WETCORR measurements.

Applications of the WETCORR-method

Some proposals for application of the method:

- cast sensors in fresh concrete (? - can the sensors endure it ?) directly below the surface and correlate with surface measurements
- below different kinds of surface treatments (paint etc)
- at all kind of facades and under eaves
- on constructions with problems regarding condensation, e.g. in stables with uninsulated roofs
- on (and perhaps even inside) walls in rooms with heavy use of water, bathrooms etc.
- on surfaces of constructions which are subjected to accelerated ageing in order to correlate the exposure to "normal" exposure conditions
- on/in old and new window frames
- on/in flat roofs

Month	February 1993	April 1993	July 1993
Description of weather	mild short on rain	dry and warm	wet and cold
Average air temperature [°C]	0.2	7.1 20th-30th: 12.7	14.5
Rainfall [mm]	29	12	110
Sunshine [h]	30 (50)	170 (220)	120 ?? (200)
Average RH [%]	92 (1st half) 79 (2nd half)	62 20th-30th: 52	70
% TOW at 20 nA	97 (1st half) 50 (2nd half)	80	50
% TOW at 100 nA	72 / 21	1	0
Min	11 nA	15 nA	7 nA
Max	665 nA	281 nA	116 nA

Table 1. Climate data and WETCORR results for selected months.

For sunshine the figure in parenthesis represents the official hours of sunshine as measured by the Meteorological Office for this part of the country. Differences could relate to the definition of how great the radiation has to be before it relates to sunshine.

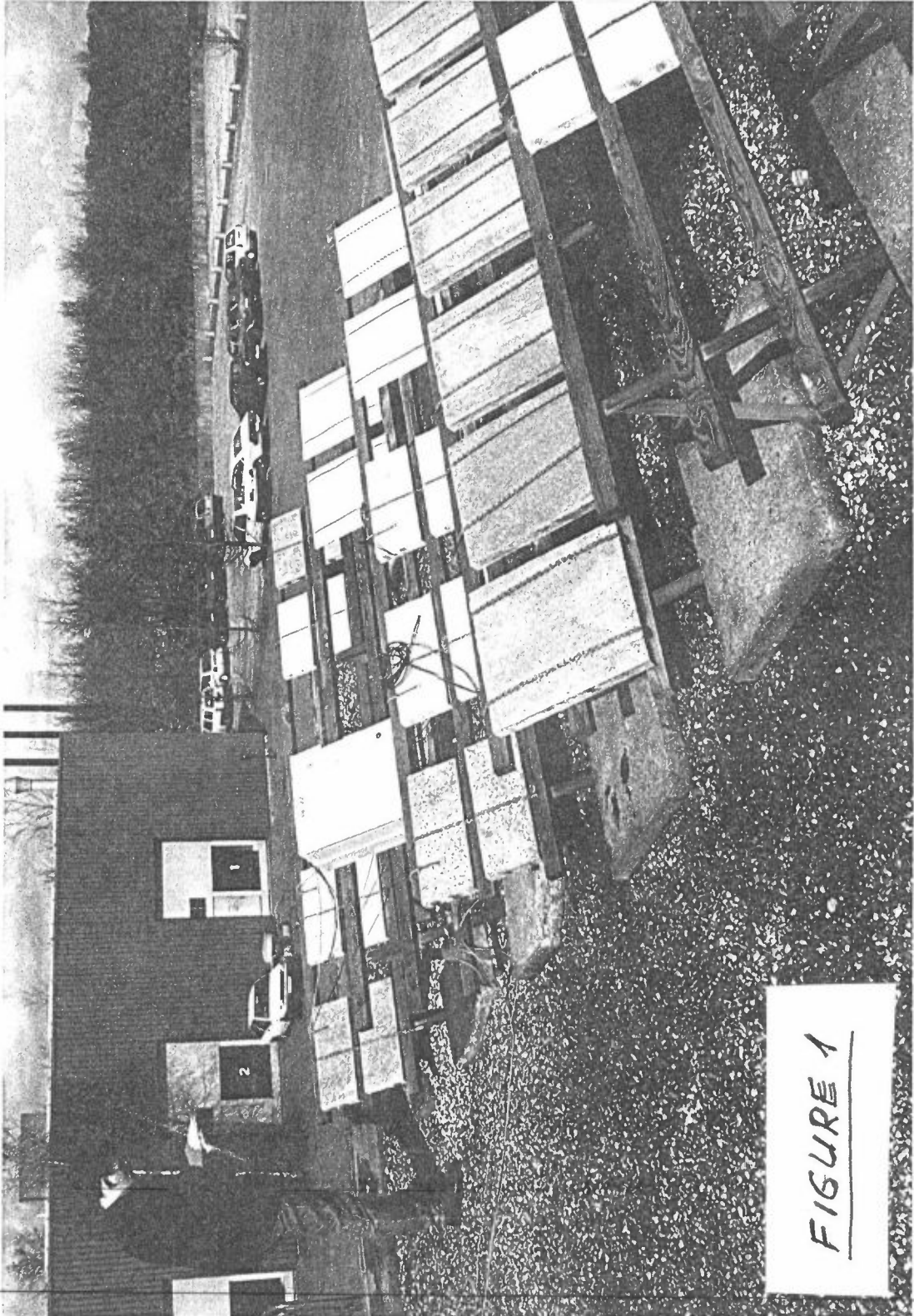
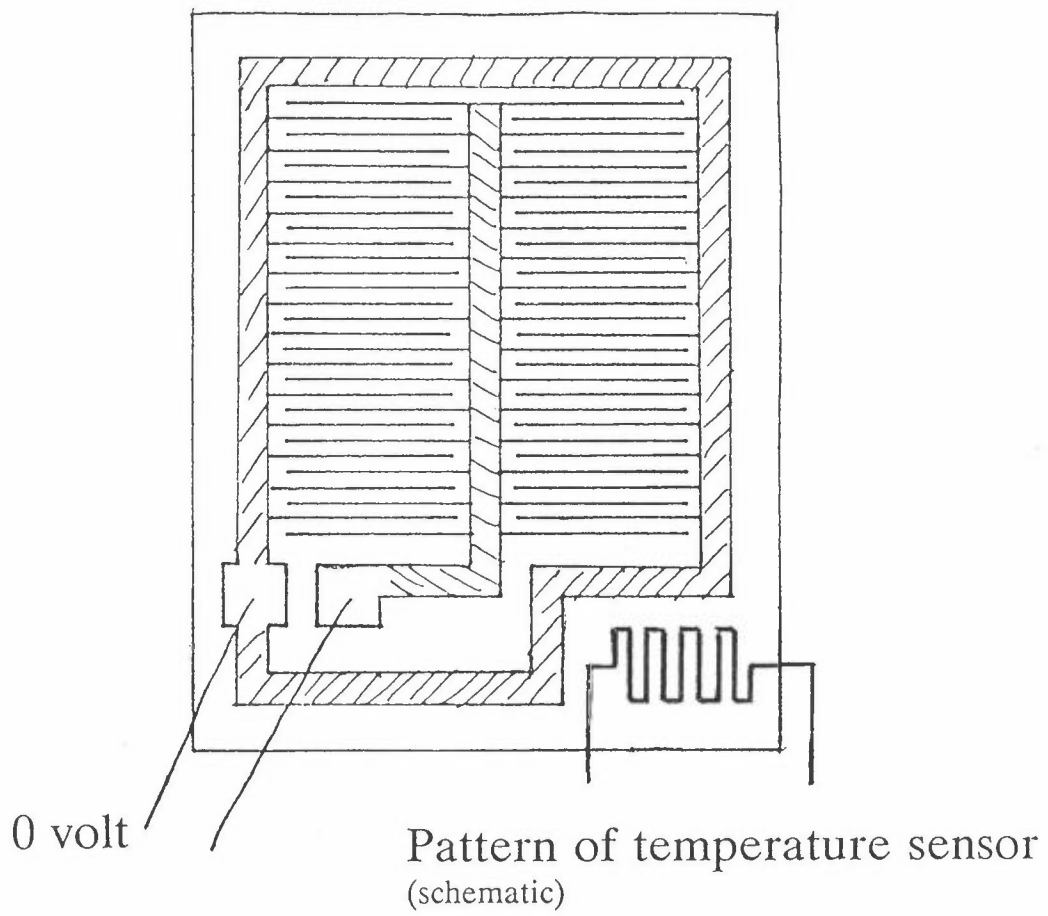

FIGURE 2



FIGURE 3

WETCORR sensor with "guard"
(schematic)



Site: 2970 2970SA01. Database file: 2970SA01.SYM, 2970SA02.SYM. Concrete slabs.

Threshold	% ToW
20 nA	92.4
100 nA	4.6

Date
93.04.06 12:30
93.04.21 00:00
93.11.16 15:55

RingSys ILAB NILU

Cell 1, Current and temperature

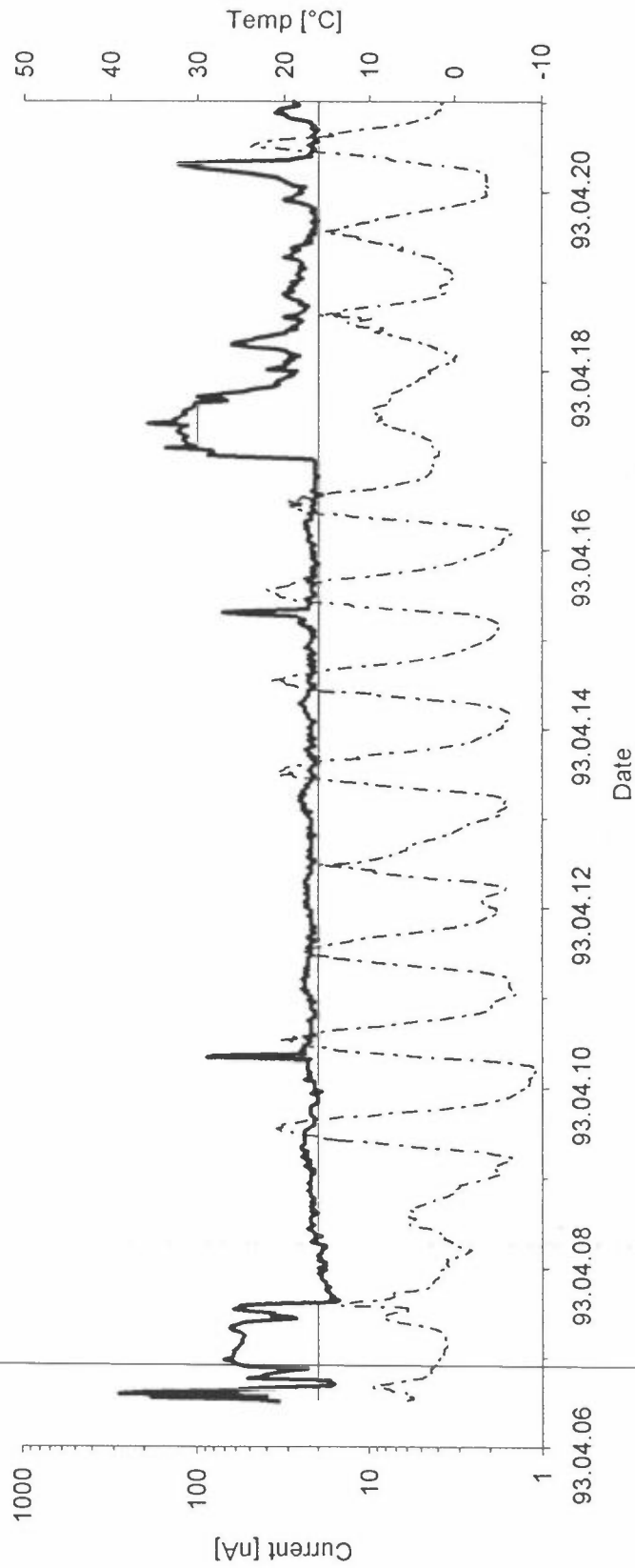

Climate data - April 1993

Rainfall and RH

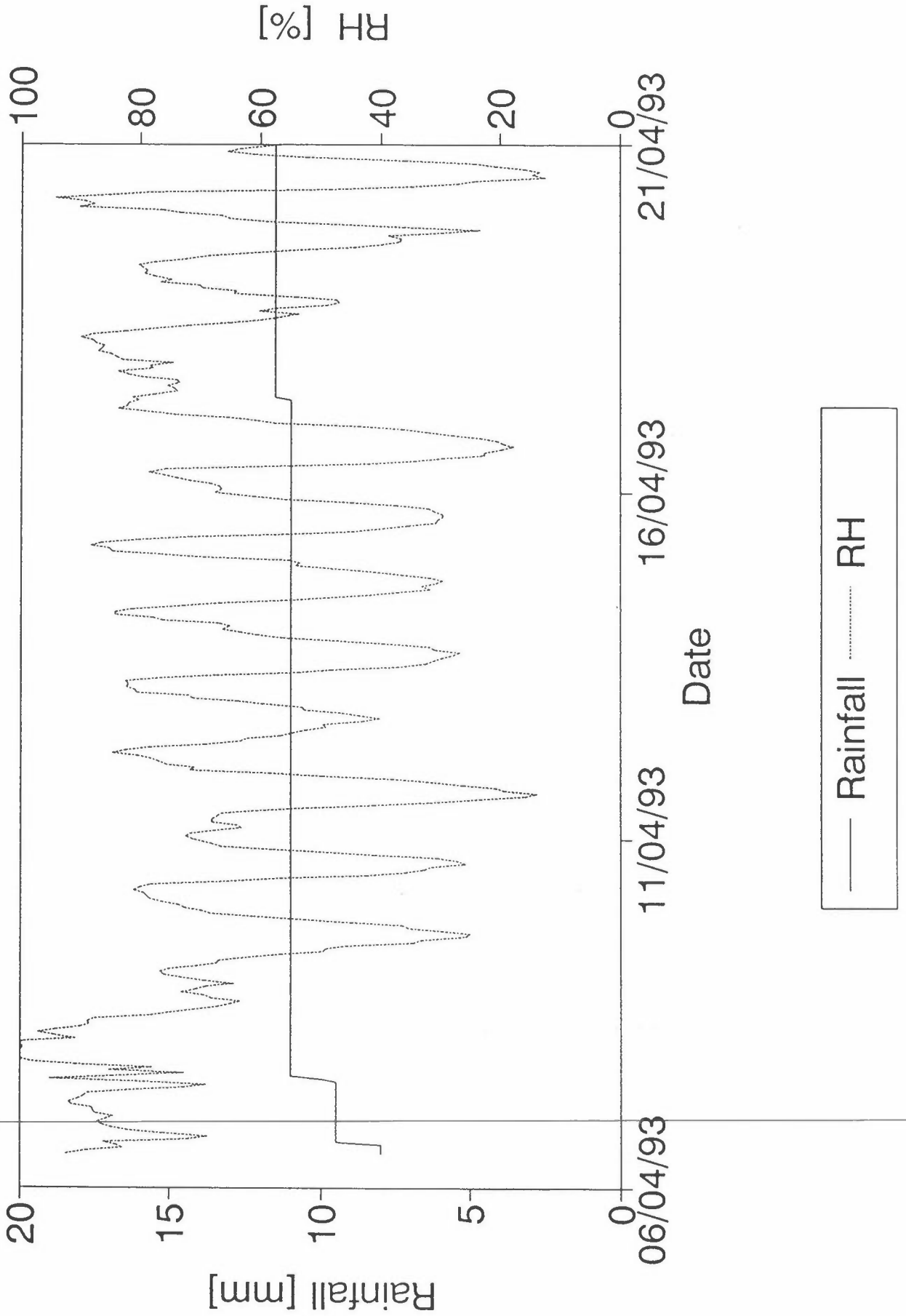

Climate data - April 1993

Air temperature and sunshine

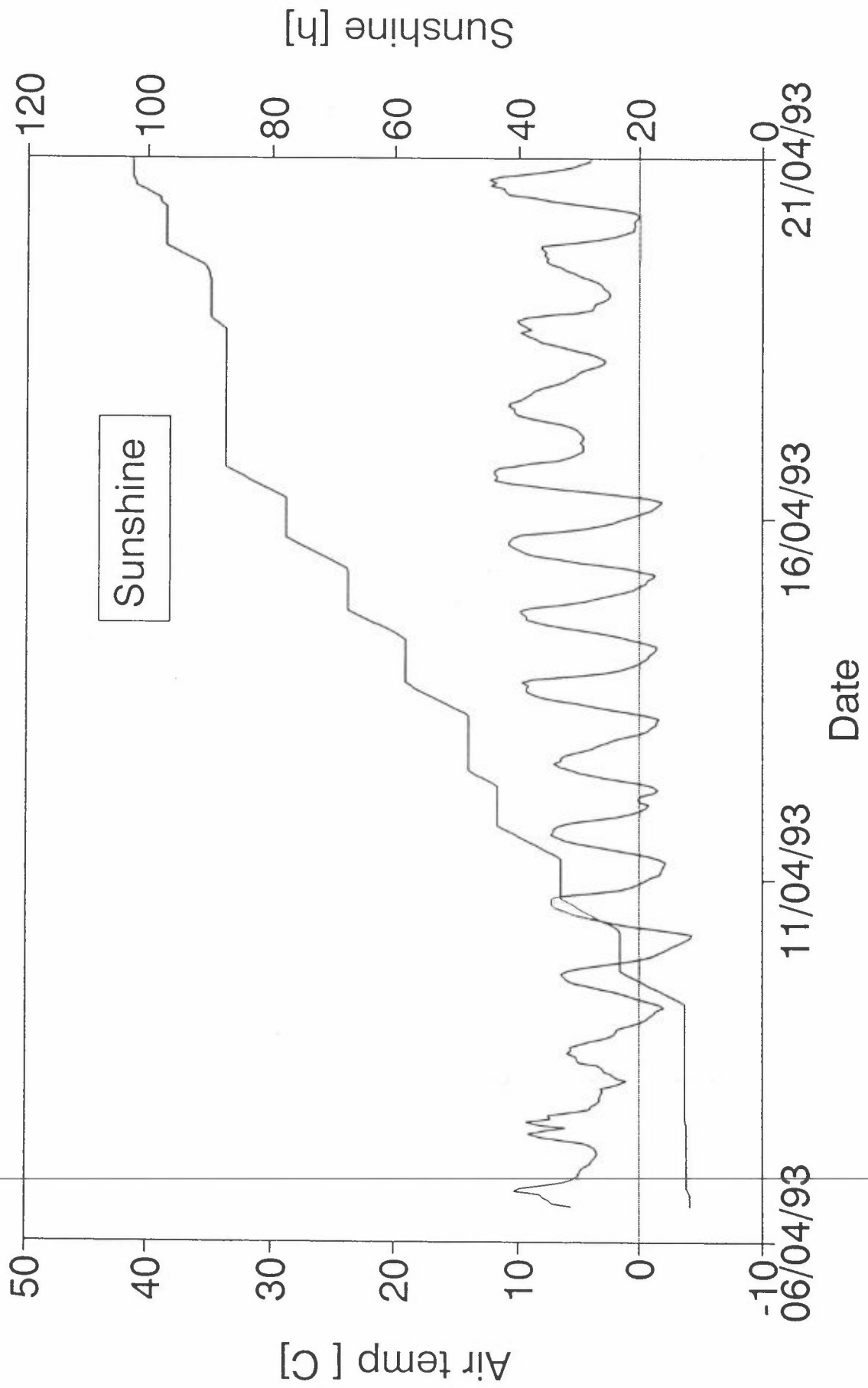

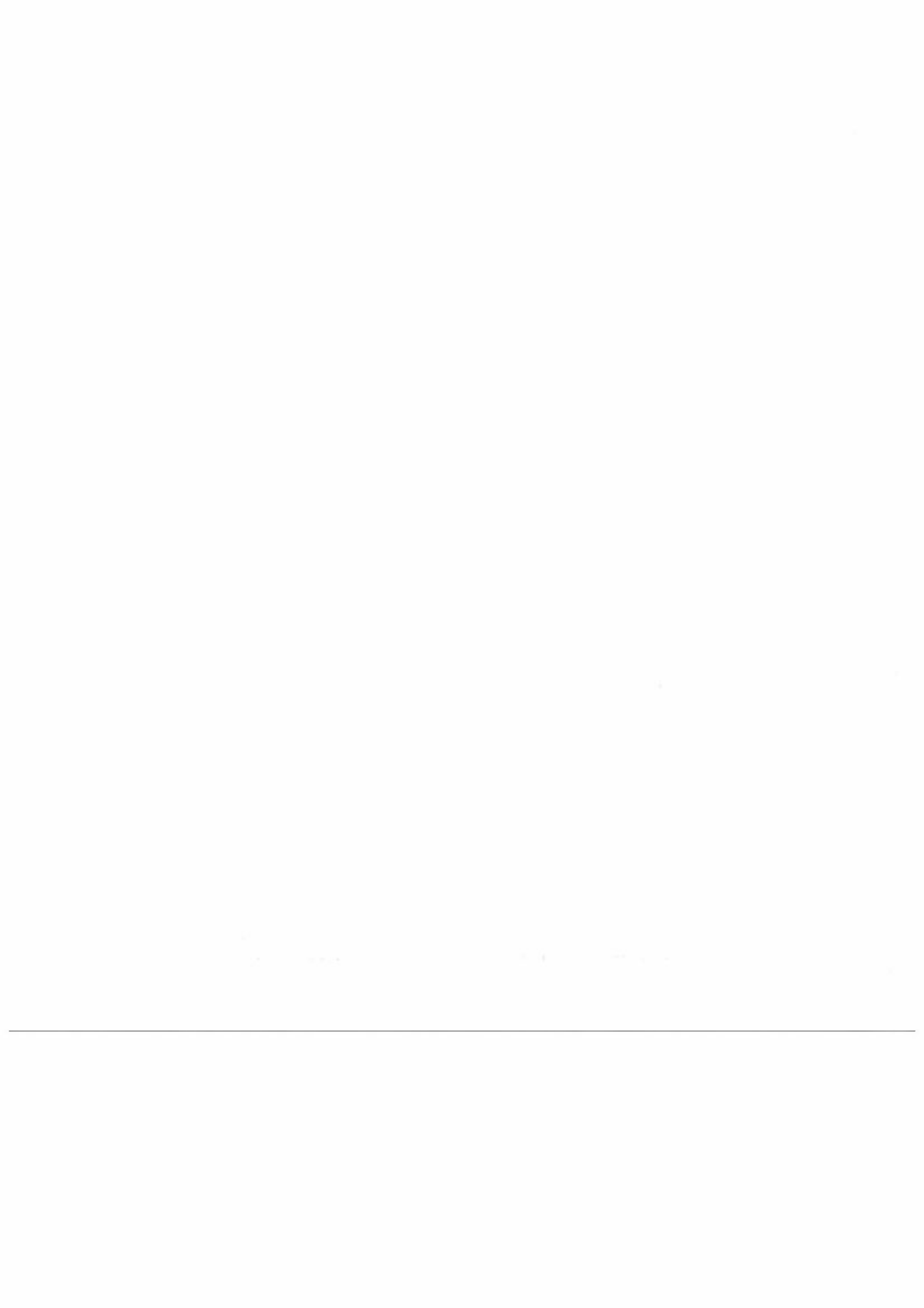

Appendix K

The usage of the WETCORR instrument in Iceland

← → ↵ ↶ ↷ ↸ ↹ ↺ ↻ ↼ ↽ ↾ ↿ ↺ ↻ ↼ ↽ ↾ ↿

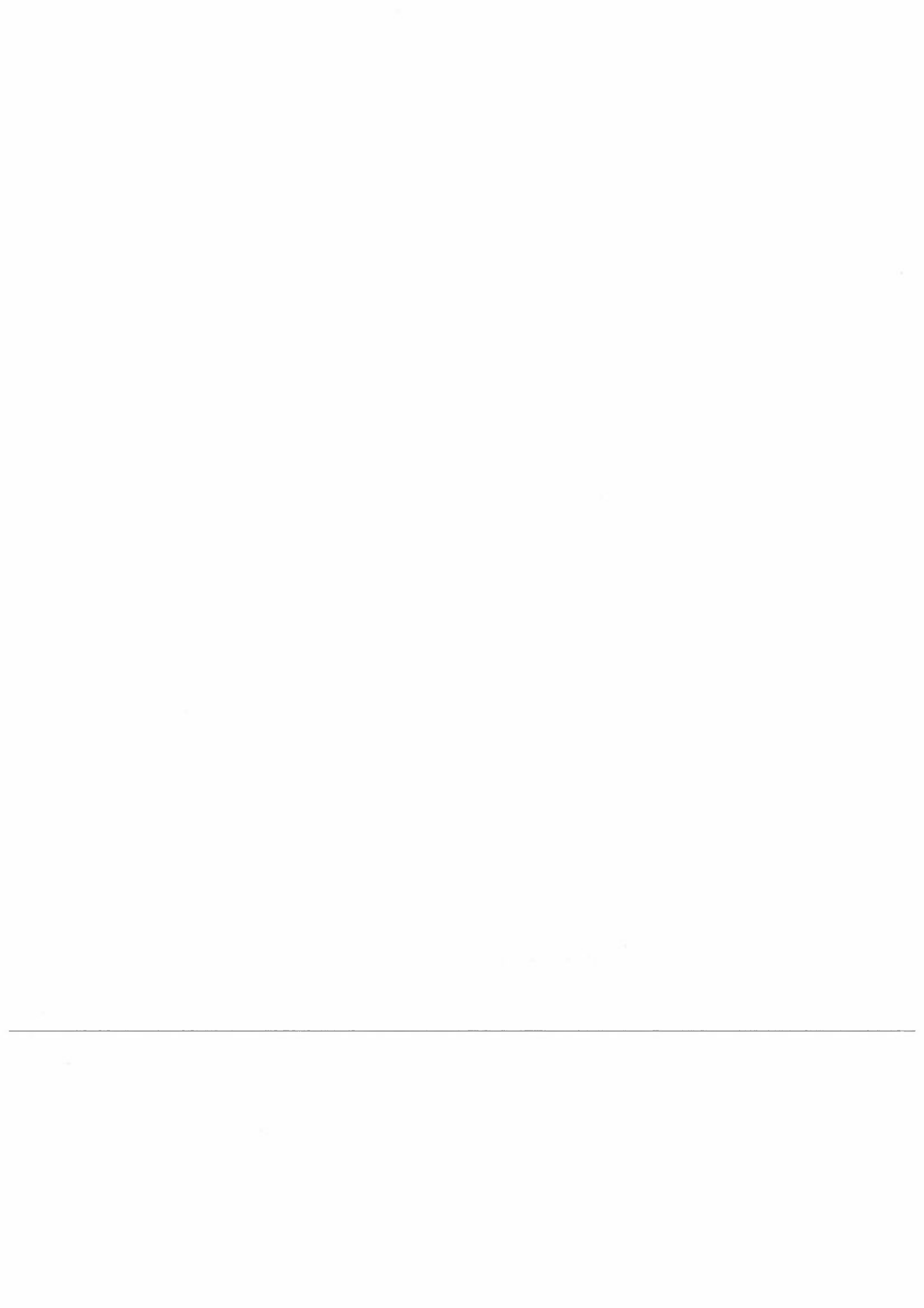



The usage of the WETCORR - instrument in Iceland

Weather conditions in Iceland are wet and windy, humidity generally around 80 % and nearly all precipitation is in the form of driving rain. These are difficult conditions for moisture absorbent building materials and materials whose life expectancy is dependent on time of wetness (TOW).

The Icelandic Building Research Institute (IBRI) is therefore interested in investigating the TOW of building materials and building components. The investigations would especially be concerned with the following:

- Monitoring the TOW on the surface of materials with different conditions and even the moisture content of the materials.
- Measuring TOW inside building components, for example behind external wall and roof cladding and in building - insulation materials (due to leakage).

The institute obtained a WETCORR instrument in the beginning of 1993 but the research project which the instrument was purchased for has not started yet. In the meantime, and to be acquainted with the instrument, measurements have been carried out on TOW for surfaces of two colours with different bearing and slope. The surfaces with sensors are placed on a small "bird-house", Fig. 1, and surface moisture and temperature measured as well as the ambient air temperature.

Processing the measurement results has started and already it is apparent that the measurement method and results provide interesting information on the micro climate.

For instance it's interesting to note the difference between the roof and wall sensors (Fig. 2 and 3) where the sensor on the wall often shows higher values than on the roof. A possible explanation can be that (approximately) 98 % of all rain in Iceland is driving rain and the mean windspeed over the year is over 5 m/s .

The use of the instrument has shown us some aspects that we wish to comment on:

- The instrument is in itself very stable in use and has a good handling characteristics.

Requirements:

Collection of information of a general character from laboratory - user to ease the decision making about data collection and transport to a computer. To name a few examples; convenient measurement rate (the amount of data grows to some huge data files !), recommended voltage on sensors (to ease later comparison between laboratories), to notify the user of different end-of-line in DOS and the Macintosh (the return/linefeed characters are used in different order to signify a new block of data).



BYGGINGARANNSÓKNIR
THE ICELANDIC BUILDING RESEARCH INSTITUTE

- The software is written to extract TOW for a sensor for any given length of time, but the software and the handbook need some (considerable) time to be understood !

Requirements:

A more flexible software to evaluate the considerable amount of data collected, and to compare data between sensors in an easier way.

- Irregularities in the current of the distribution net result in an very localised scramble of the data file, but these make the files hard to process.

Requirements:

A software to manipulate the data to filter out irregularities, and even to make the data accessible to other "brands" of software.

The instrument gives a large amount of data which may easily be used to determine the TOW if such a term is pre-defined for the material in question. For many materials the degradation process is of course dependant on TOW but also on the amount of water on the surface, the TOW compared to following drying-out conditions and even an reaction between TOW and other environmental factors. It would be interesting to see if the instrument could even be used to quantify the amount of water on the surface. The instrument gives an information that can be used for more than only calculating the TOW as the results show time-series of the wet-dry condition of the surface, now its more a question how to evaluate the data to be able to compare sites.

Our experience of the instrument has thus far been good. We still plan to start the projects concerning moisture content of porous building materials and the time of wetness behind claddings. In these projects the instrument will be very important to measure the TOW.



BYGGINGARANNSÓKNIR
THE ICELANDIC BUILDING RESEARCH INSTITUTE

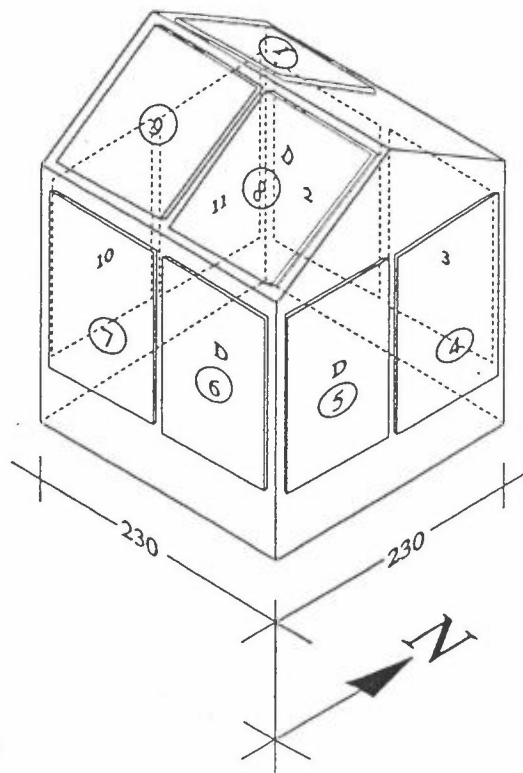

The numbering of sensors on the "bird house"

SENSOR ADAPTER no.	SENSOR NO:			
	1	2	3	4
SA01	1	2	3	4
SA02	5	6	7	8
SA03	9	10	11	12
SA04	13	-	-	-

No. 12 is placed side by side with nr. 9, but the temperature sensor is painted white
No. 13 measures ambient air temperature

Fig. 1 The "bird-house" with sensors



BYGGINGARANNSÓKNIR
THE ICELANDIC BUILDING RESEARCH INSTITUTE

Station: 1121 SA02

	Date	Time
From:	931101	0000
To:	931122	2130
Printed:	931123	0109

RingSys ILAB NILU

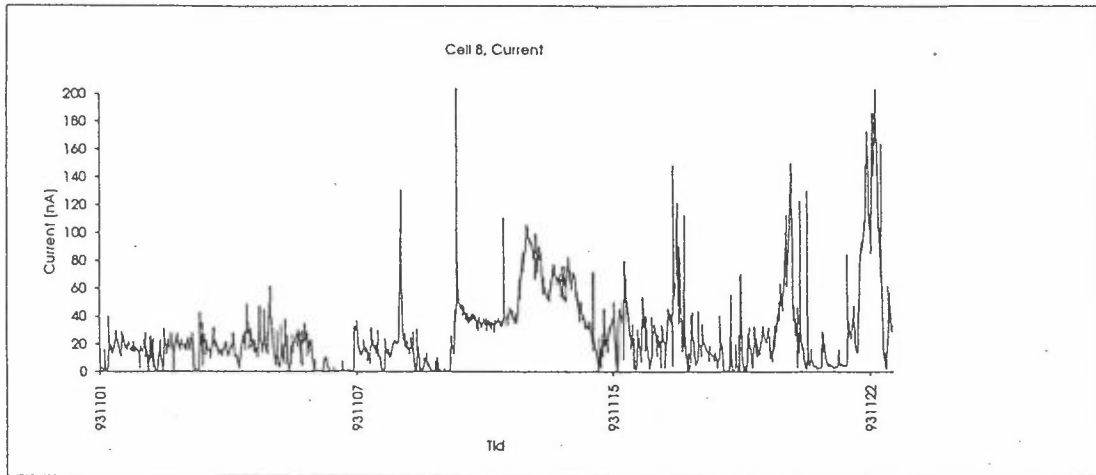

Fig. 2 Sensor no. 8 on the roof of the box (Fig. 1)

Station: 1121 SA02

	Date	Time
From:	931101	0000
To:	931122	2130
Printed:	931123	0103

RingSys ILAB NILU

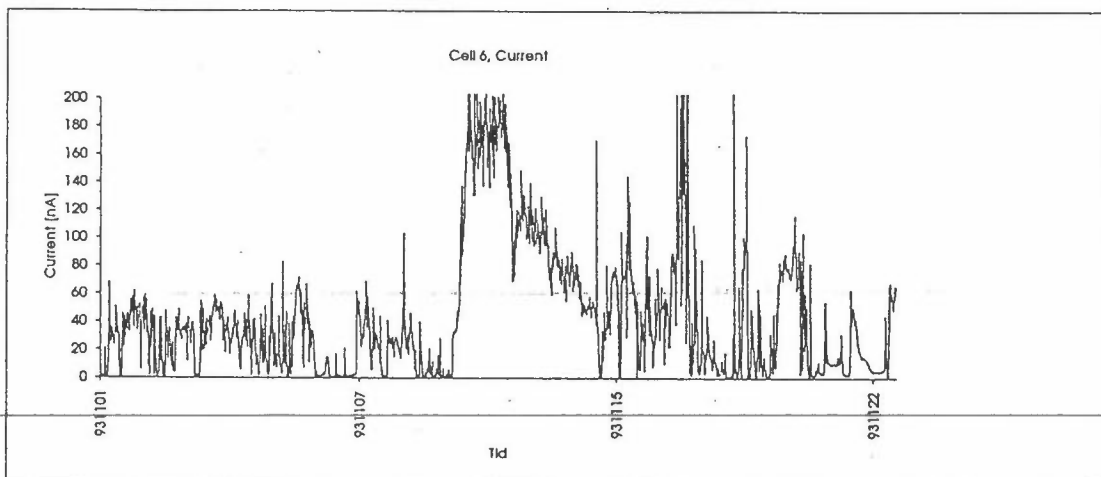

Fig. 3 Sensor no. 6 on the south-wall (Fig.1)

Appendix L

Laboratory and field test at SIB

Laboratory and field tests at SIB, Part 1

Peter Norberg, SIB, GÄVLE, Sweden

Introduction

This presentation deals with the latest development of Wetcorr instrument and how it compares to an older version being used at SIB since 1986. In addition, the new type of gold sensor has been evaluated in long-term tests where 12 sensors in parallel were compared. The surface moisture studies took place on the roof of the institute. The contents of the following text is extracted from Norberg (1993).

Measuring conditions

The evaluation of the new surface moisture sensor started in June 1991 and has to a large extent been made with an old Wetcorr instrument. The new system did not become available for testing until December 1991. This fact, however, made it possible to compare the new system with the old one using the same sensor set-up.

A first set of 12 sensors were mounted on two pieces of coil coated sheet metal in aluminium, using Scotch double stick adhesive, type 950. The two sheets were mounted vertically on the north-east wall of a superstructure situated on the roof of the institute. This means that the sensors would be in the shade most of the time, particularly in the winter. The surface temperature sensing part of the combined sensor could not be connected to the old instrument. Instead, a separate thermocouple was screwed onto the back of one of the sheets. In addition, a combined humidity-temperature probe, Rotronic MP-100 was used to monitor air temperature and relative humidity close to the measuring position.

The above measurements were running between 17 June and 18 August, 1991. After that, all the sensors were replaced for a new set of 12 sensors, and the second period of measurement continued from 26 August to 15 December, 1991.

In December 1991, when the new Wetcorr instruments arrived, it seemed appropriate to devote one instrument to the running sensor evaluation programme, simply by connecting six of the sensors to the new instrument and keeping the remaining six connected to the old instrument. In this way, it should be possible to compare the current response of the same set of sensors but with different instruments, and also to compare the two groups of six sensors during the continued measurements using the two instruments in parallel. This third period of measurement took place between 23 December, 1991 and 23 March, 1992.

Results

In order to condense the large amount of data available, the weekly current averages for each of the 12 parallel sensors were calculated for the three test series conducted at the exposure site of the institute. The results of the first two test periods are plotted together with the average relative humidity in the presented figures. The mean and standard deviation was calculated for the 12 averages of the two periods. The ratios of mean current and standard deviation over the periods were 18 and 22%, respectively.

There is an obvious co-variation between the logarithm of the current through the sensor and the relative humidity of the ambient air. Deviations should, however, be expected since there was no record kept of occurrences of rain or of any other conditions that may be of importance.

The results of the last exposure period have been splitted up into the two sub-sets of sensors connected to the old and the new Wetcorr instrument, respectively. As is obvious, there is no significant difference in mean current between the two sets of sensors. These two groups could also be compared in retrospect during the previous test period, when only the old instrument was used. Virtually the same relative difference in mean current was found for that test period, giving support to the conclusion that the new Wetcorr system works in the same way as the old instrument, as far as the actual measuring technique is concerned.

TOW-estimates using the current criteria 10 and 100 nA have also been made. In general, all sensors give roughly the same result and the typical standard deviation for each set of 12 sensors is typically 10% in relative terms. However, there will always be large individual variations in the estimated TOW when the criterion is on the same level as the current variation. If, for example, high-humidity conditions prevail for a considerable period of time, the current through the sensors will also stay at a high and fairly constant level. As it happens, some sensors will reach above the chosen criterion while the current of others will be just below. This means that for the considered period some sensors will measure 100% TOW and some 0%, even though their relative difference in current may be as small as 10%. Thus, it seems advisable to make TOW-estimates for more than one current criterion in order to avoid misinterpretation of border line cases.

Discussion and conclusions

The new Wetcorr system has been evaluated for nearly two years under field conditions. It appears that data produced with the new instrument do not differ from those obtained by an older instrument, working according to the same measuring principle. Installation and operation of the system is very simple. Data retrieval and processing by PC require some experience and detailed knowledge about the programme structure. For routine measurements many of the steps in the evaluation process are made automatically in accordance with custom commands and criteria.

The relative standard error in the measured current between different sensors is about 20%. However, the nature of surface moisture implies that some of this variation has to do with actual differences in moisture deposition on the individual sensor.

The detection limit for relative humidity is not possible to deduce directly from the presented data. According to the arrangement of the current and relative humidity axes in the three figures presented, the lowest resolvable current, which is 1 nA, would correspond to 60 %RH. Since the dependence of the logarithm of the current on relative humidity is not linear but rather quadratic, the average currents will overestimate the sensitivity. The results show that 1 nA would correspond to a relative humidity in the range 70 - 80 %RH. This means that the present moisture sensor is less sensitive to relative humidity than a slightly different sensor previously evaluated under constant climatic chamber conditions, Norberg (1990).

The current flowing through the cell seems to be saturated at about 100-200 nA for clean sensors. Saturation can be caused by high relative humidity as well as by rain or dew. This means that just by looking at the variation in current, it seems difficult to decide whether the peaks are related to rain, dew or high relative humidity, or some combination of these and other factors. Moreover, rainfall on top of high relative humidity would not change the current response very much when saturation has occurred.

In order to avoid misinterpretation of border line cases it seems advisable to make TOW-estimates for more than one current criterion.

The circumstances have not yet permitted a thorough study of the accuracy of the surface temperature transducer and neither of how relevant the obtained values are. The importance of knowing the surface temperature can be exemplified by the fact that the surface temperature measured on the coil coated sheet metal on an average was about 4°C lower than the temperature of the ambient air. This difference implies that if the relative humidity is 80 %RH or higher in the air, condensation would occur on the sheet metal as well as on the surface moisture sensor.

References

Norberg, P. (1990) Monitoring of surface moisture by miniature moisture sensors. **Proc. 5th Int. Conf. on Durability of Building Materials and Components**, Brighton, 7-9 Nov, 1990, pp 539-550.

Norberg, P. (1993) Evaluation of a new surface moisture monitoring system. **Proc. 6th Int. Conf. on Durability of Building Materials and Components**, Omiya, Japan, 26-29 Oct, 1993, pp 637-646.

EXPERIMENTAL SET - UP

2 x

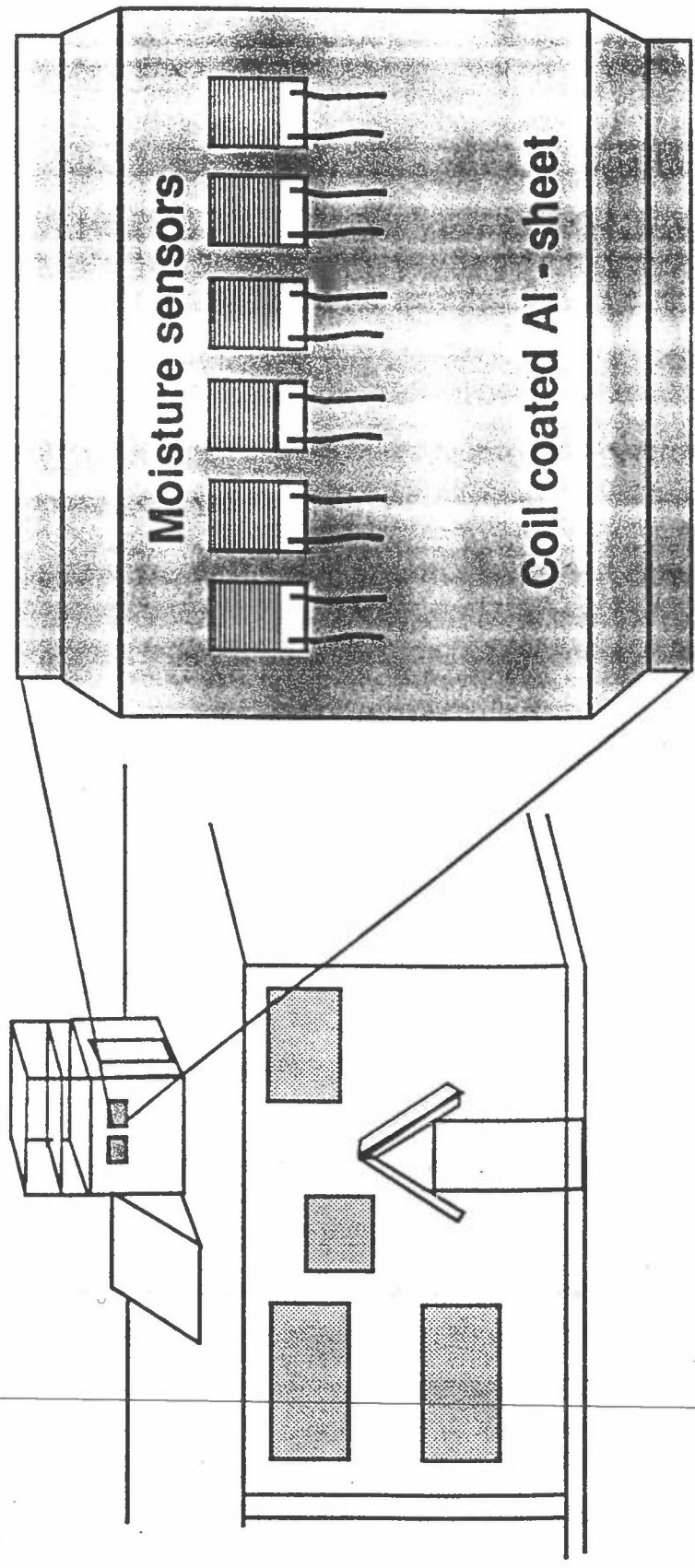

Weekly averages for the first set of 12 sensors

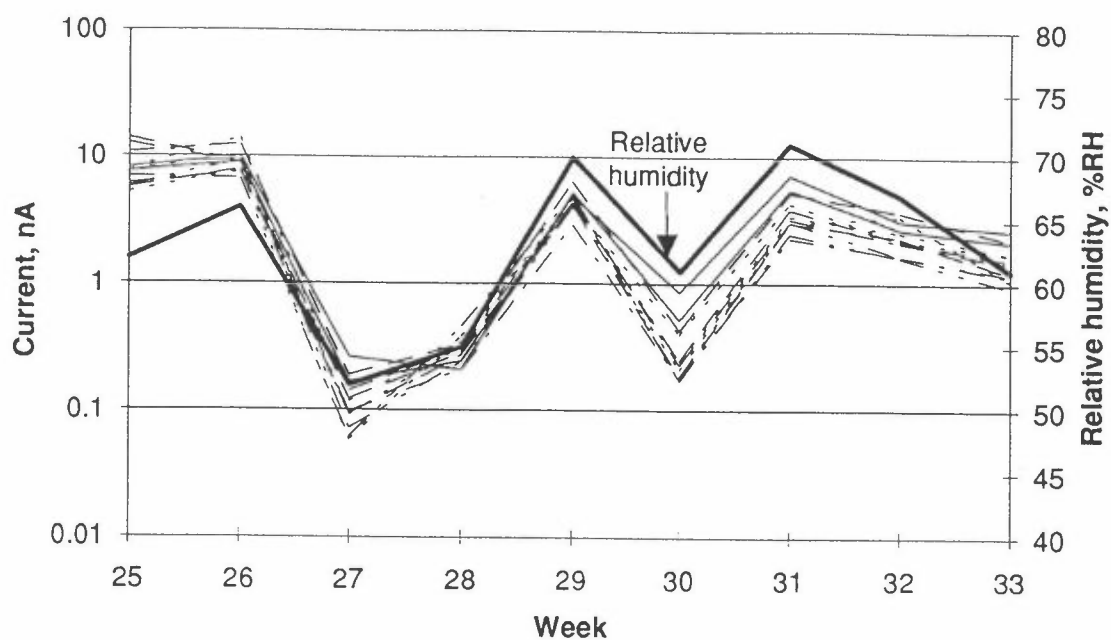

Weekly averages for the second set of 12 sensors

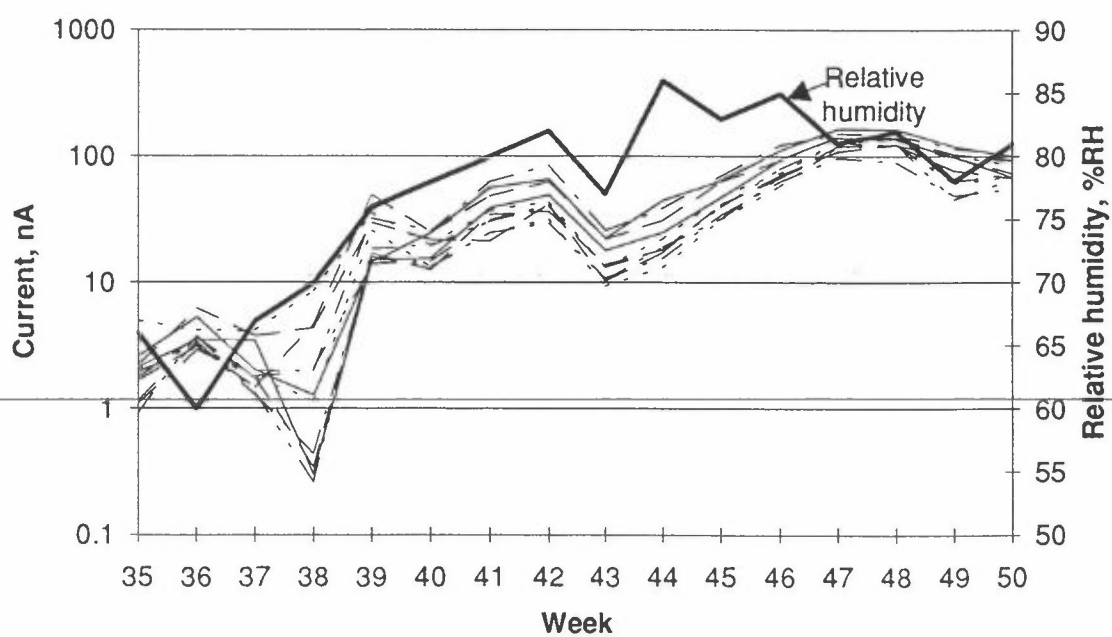

Comparison of the new and old Wetcorr instruments

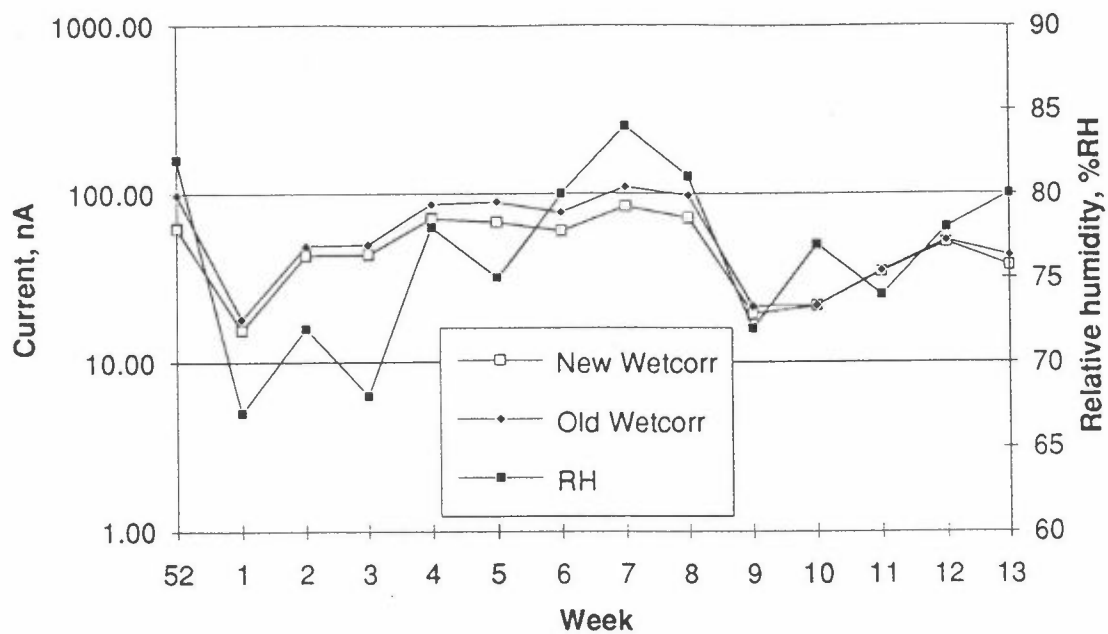

Conclusions

- * **The new WETCORR system is easy to install and operate**
- * **Data retrieval and processing can be made automatically**
- * **The data generated with the new instrument are compatible with those obtained with previous versions of WETCORR**
- * **The new sensor responds to RH >70% and the recorded current primarily follows the ambient relative humidity**
- * **The standard deviation of the recorded current for 12 parallel sensors is about 20%**
- * **The sensors normally used are sensitive to pollution deposition in sheltered positions**

Laboratory and field tests at SIB, Part 2

Peter Norberg, SIB, GÄVLE, Sweden

Introduction

The present document summarizes SIB's experience with the Wetcorr method in various tests along with some proposed applications.

Studies indoors

Some years ago the Wetcorr method was used to study the surface moisture loads experienced in high-humidity compartments of an inhabited dwelling.

Measurements were carried out during approximately one week in, respectively, a shower cabinet, a bathroom and a laundry. Two types of moisture sensors were used, one gold sensor of a previous design and a commercial dew sensor called Murata HOS103, see Norberg (1990).

Both sensors were mounted in pairs at four different locations on the walls of the compartments. In general, the sensors were placed so that the extremes with regard to moisture load would be represented. This meant e.g. that walls with different surface temperature were selected. As a rule, two pairs of sensors were placed 50-100 mm from the floor level and the other two pairs 100-200 mm from the ceiling.

In the bathroom, one pair of sensors were mounted behind the bath tub near the floor. The distance between the the wall and the edge of the tub was about 50 mm, ensuring acceptable ventilation of this critical area. In all other locations the sensors were openly exposed.

In both the shower cabinet and the bathroom an RH-probe was mounted close to the shower nozzle but away from the pouring water. The surface temperature of the coldest wall and also of the air was measured in all compartments.

The results shown in the first table show that there is a good agreement between the two sensors and the RH-probe in the comparable location. Examples of current-time plots for the gold sensor close to the floor and close to the ceiling of the shower cabinet are shown in the attached figures. A summary of the moisture times obtained for various locations on the walls of the shower cabinet and the bathroom is given in the two following tables. In the case of the laundry, the relative humidity never exceeded 60 %RH despite line drying of the clothes and closed door. This was not sufficient to generate critical moisture levels on any of the walls of the laundry.

The overall conclusion from this study was that the Wetcorr method proved to be very useful and reliable to quantify surface moisture loads.

At present, a similar study is being conducted in the laboratory dwelling of SIB, where the influence on the surface moisture loads of ventilation conditions and different modes of drying the laundry are studied.

Measurements in wood and paint films

Preliminary tests have shown that the Wetcorr technique with advantage can be used for monitoring of moisture conditions in wood and paint films on wood. In such cases, alternative sensors or electrodes are used but connected to the Wetcorr instrument.

The moisture content of wood can be measured by applying the same type of nails or electrodes as the ones used with traditional devices, e.g. Timbermaster. Thanks to the low voltage applied (100 mV) and the polarity reversal, the Wetcorr technique should have less impact on the chemistry of the wood substance than the traditional technique.

Experiments with Pt-wires (25-50 μm), embedded in the paint film have demonstrated that very interesting effects in relation to the wetting and drying of the material can be disclosed. It is, however, too early to judge to what extent these observations can improve our understanding of the moisture dynamics of different paint films and how this relate to various aspects of durability of painted wood.

The above sensor techniques are currently employed in the Eurocare Prowood project along with the normal Wetcorr sensor.

Other applications

The following is a list of suitable applications of the Wetcorr method indoors as well as outdoors.

- Surfaces towards the air cavity behind wood panels
- Metallic ties and fasteners in brick cavity walls
- Surfaces between different moisture barriers and thermal insulation layers
- Foundations (slab on ground, crawl-space)
- Moisture monitoring in different roof cladding layers
- Studies of moisture conditions in various parts of windows
- Determination of actual and critical moisture conditions, e.g. in relation to frost attack of concrete and mould attack of wood
- Studies of surface condensation on walls, windows, floors etc.

Reference

Norberg, P. and Sjöström, Ch. (1990) Time-of-wetness measurements in high-humidity compartments of dwellings. Paper I19. **Proc. Int. CIB W67 Symp. on Energy, Moisture, Climate in Buildings**, Rotterdam, 3-6 Sep, 1990.

TABLE 1. Comparison of Various Moisture Time Estimates for Locations Close to the RH-probe. Moisture Criteria According to Eq. 1.

Compartment	Moisture time (TOW), %		Showering time, %	Average air temp., °C
Moisture crit.	Au/Au	HOS103 RH-probe		
Shower cabinet				
70% RH, 20 °C	5.0	-	4.0	
80% RH, -"-	1.8	- *	1.0	
90% RH, -"-	0.7	0.4	0.6	20.6
Bathroom				
70% RH, 20 °C	3.8	-	3.3	
80% RH, -"-	3.1	- *	2.2	
90% RH, -"-	2.7	2.4	1.8	21.3

* For Murata HOS103 a current of 10^5 nA corresponds to 90% RH, 20 °C

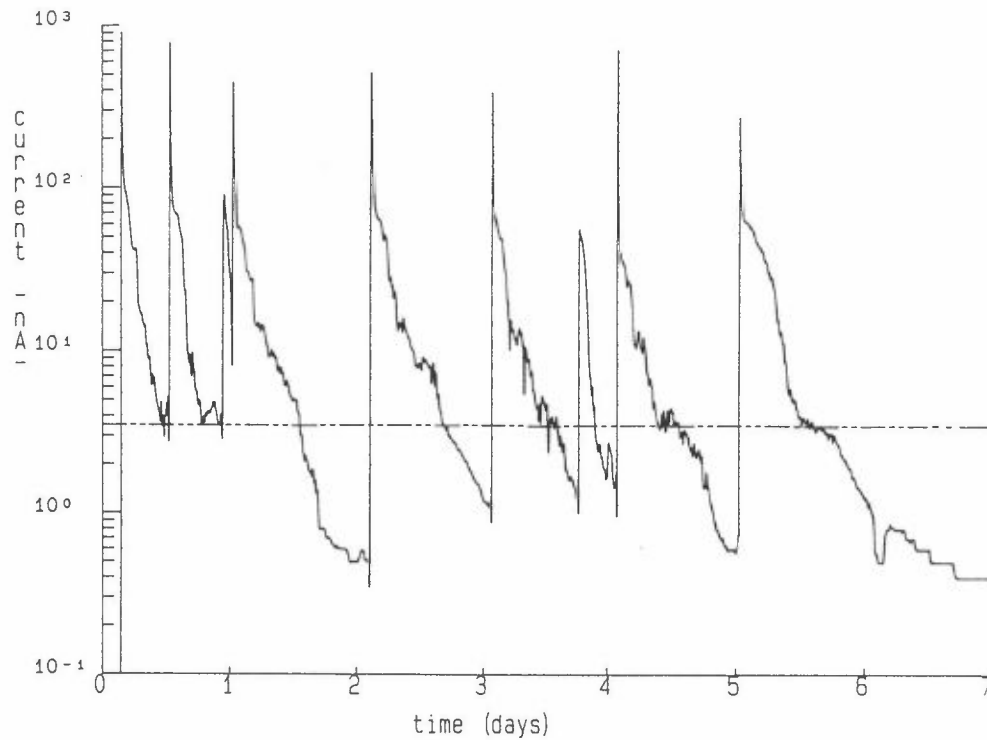

FIGURE 1. Current-time curve for Au/Au-sensor mounted close to the floor of a shower cabinet. The line represents 80% RH, 0°C.

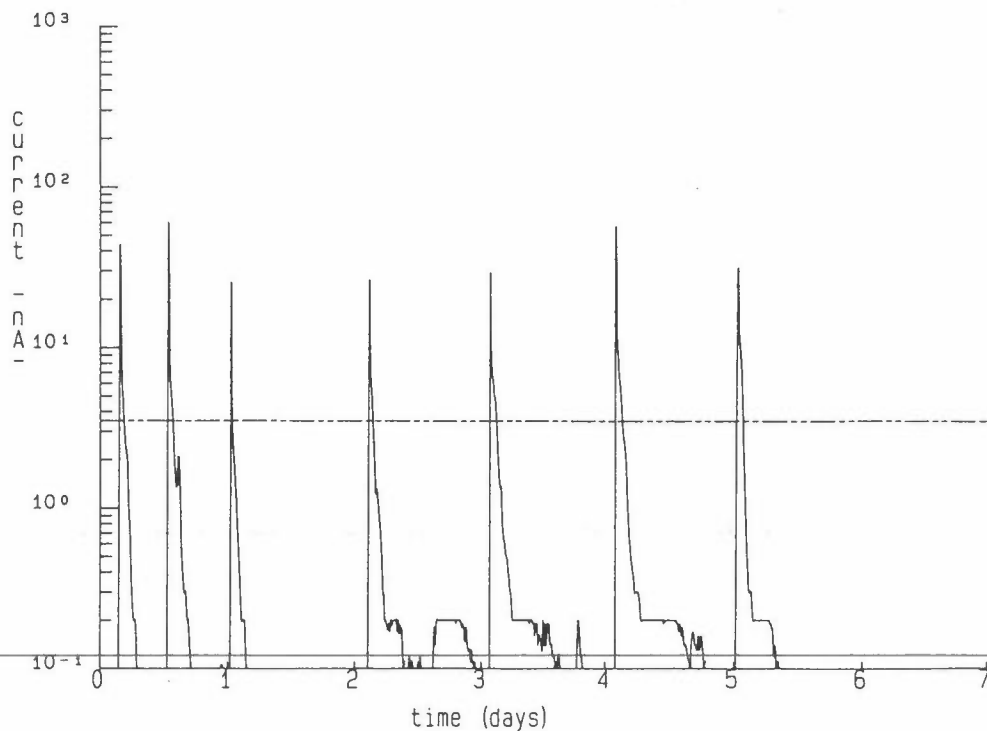

FIGURE 2. Current-time curve for Au/Au-sensor mounted close to the ceiling of a shower cabinet. The line represents 80% RH, 0°C.

TABLE 2. Moisture Times for Various Locations on the Walls of a Shower Cabinet. Total Showering Time = 0.47% of 7 Days.

Sensor location	Moisture time (TOW), %			
	Au/Au-sensors			Murata HOS103
	70%RH, 0°C (=1.1 nA)	80%RH, 0°C (=3.5 nA)	90%RH, 0°C (=13.2 nA)	90%RH, 0°C (=10 ⁵ nA)
Close to floor, shower side	74.9	49.8	22.5	7.6
Close to ceiling, shower side	7.8	3.9	0.9	0.4
Close to floor, opposite shower	62.3	39.0	19.4	15.3
Close to ceiling, opposite shower	10.7	5.9	3.0	0.90

TABLE 3. Moisture Times for Various Locations on the Walls of a Bathroom. Total Showering Time = 1.33% of 7 Days.

Sensor location	Moisture time (TOW), %			
	Au/Au-sensors			Murata HOS103
	70%RH, 0°C (=1.1 nA)	80%RH, 0°C (=3.5 nA)	90%RH, 0°C (=13.2 nA)	90%RH, 0°C (=10 ⁵ nA)
Close to floor, behind bath tub	44.6	30.9	5.4	7.7
Close to ceiling, above bath tub	5.1	3.4	2.9	2.4
Close to floor, opposite bath tub	5.1	3.8	2.1	2.6
Close to ceiling, window wall	2.8	2.5	2.3	1.8

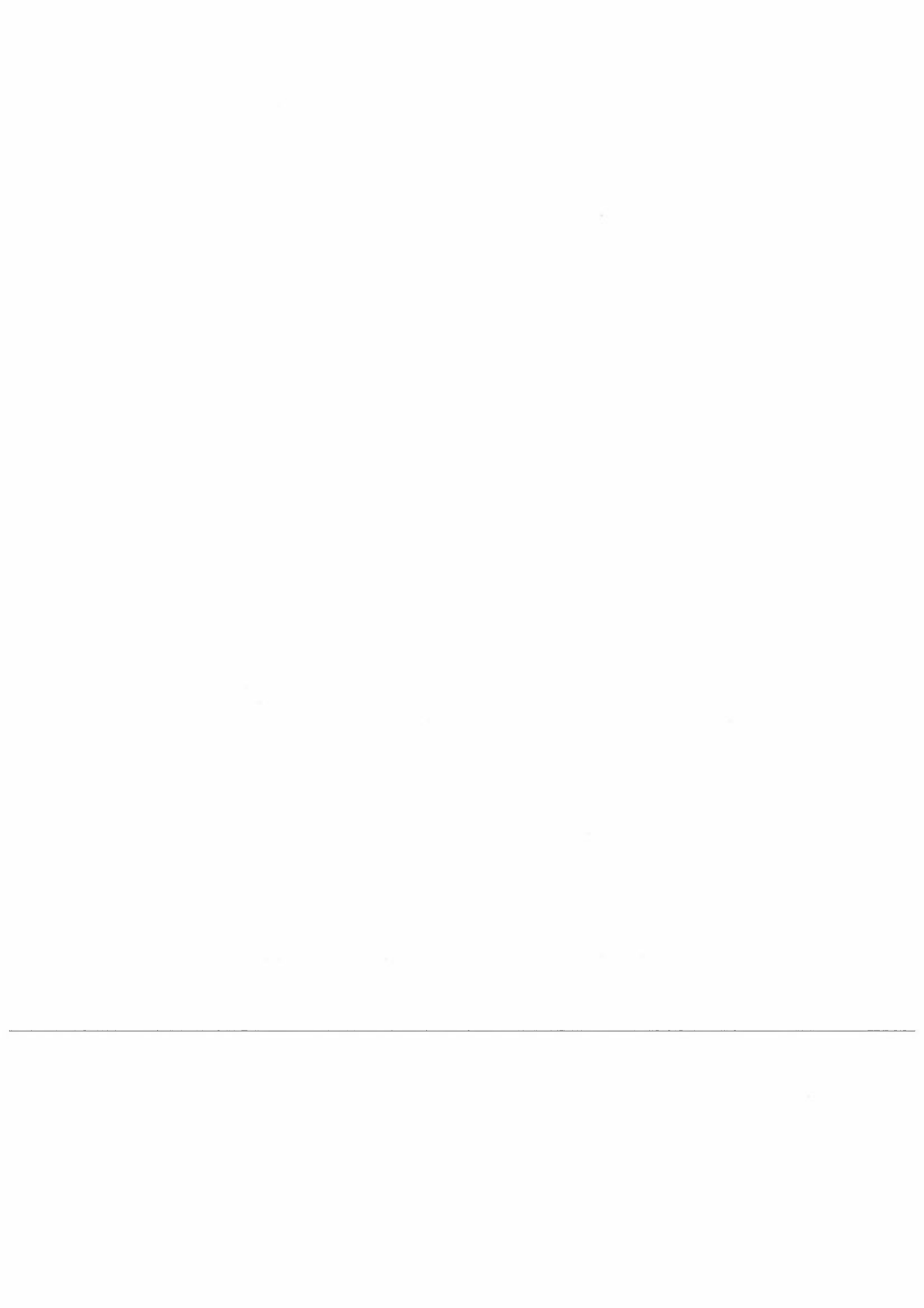

Appendix M

Wetness impact around windows

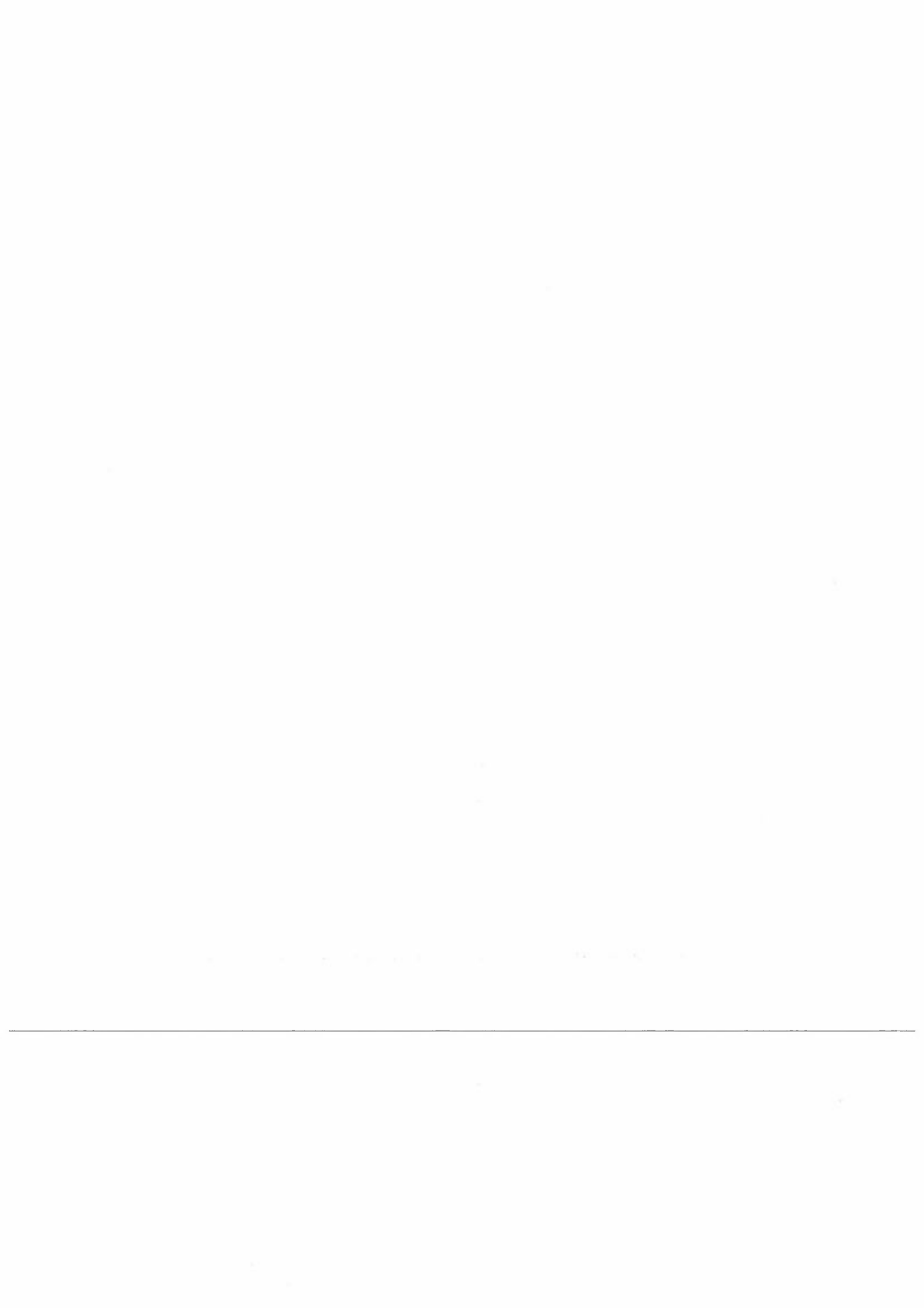

Surface Moisture and Temperature on a Windowframe

Measurements with the
WETCORR - instrument

Bengt Svennerstedt
Lund, Sweden

Purpose of the project:

- * Evaluate the new WETCORR-instrument
- * Measurementdata for a window

Measurementperiod:

16.2 - 16.4 1993

LÄSVÄGEN, LUND

SW-FASAD

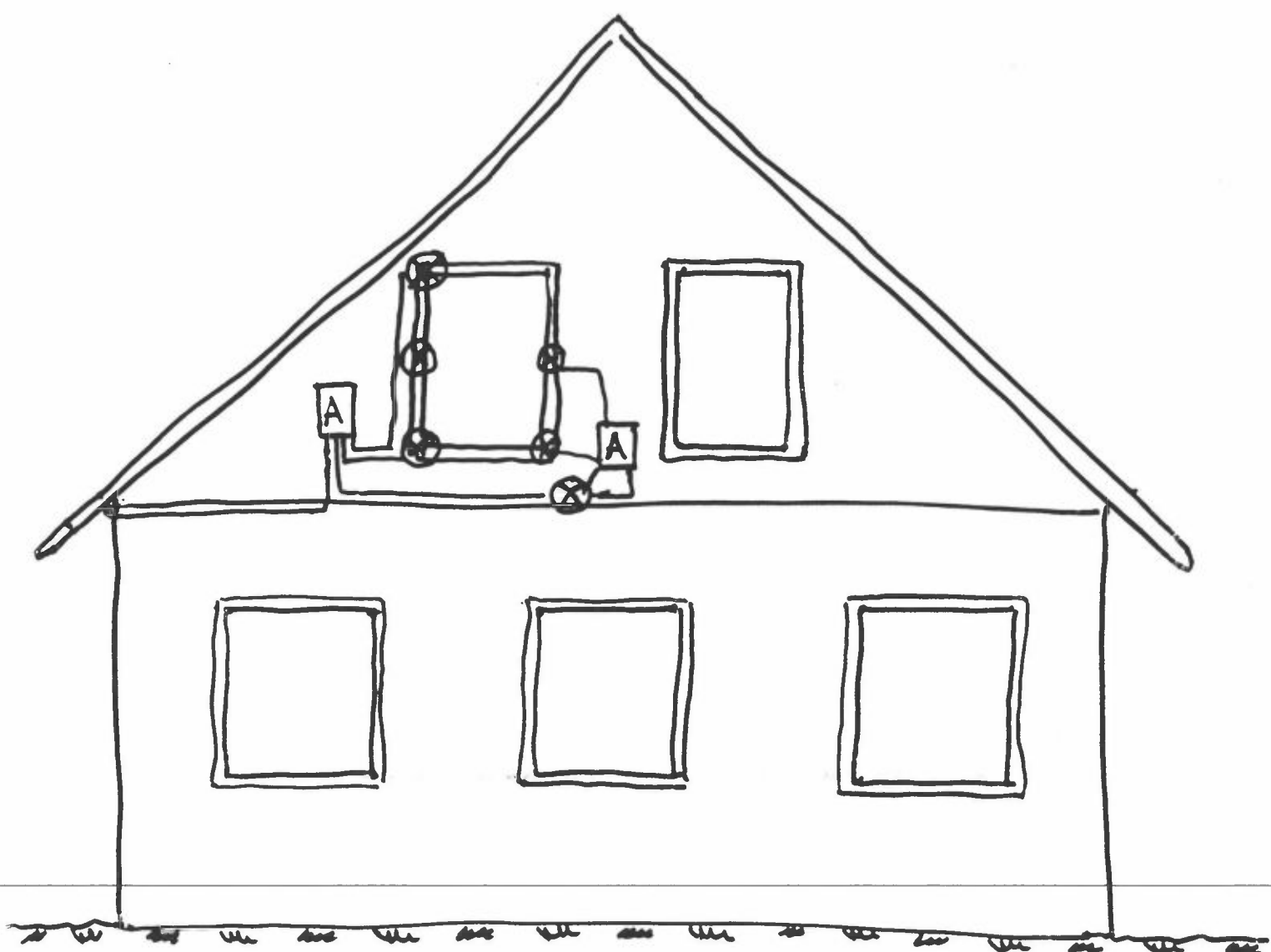

Surface Moisture on a Window - Measurements for 19.2 1993

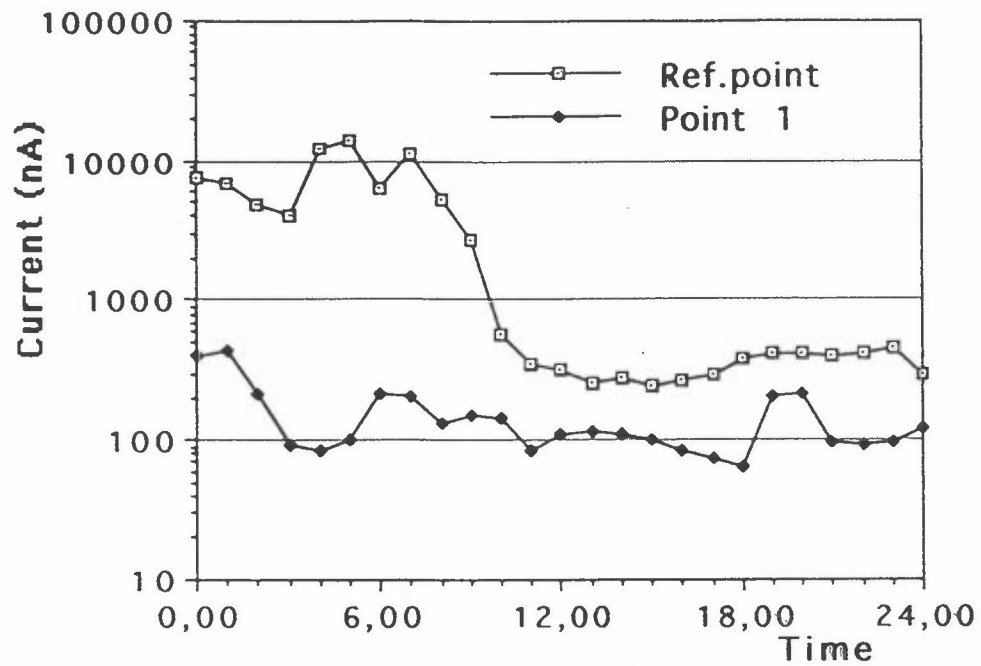

Surface Temperature on a Window- Measurements for 19.2 1993

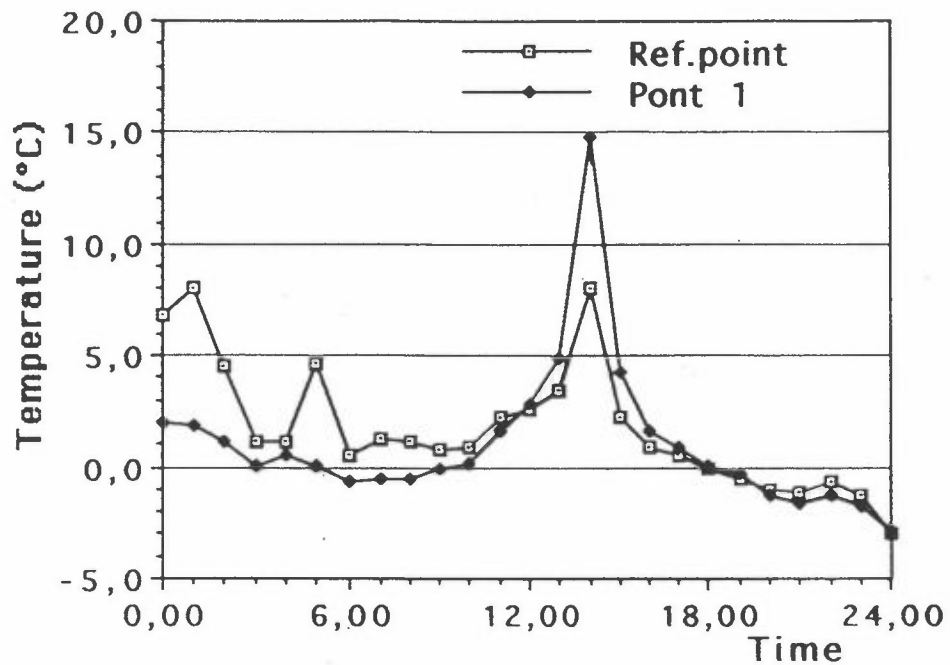

Conclusion

- * The new WETCORR -equipment functioned very well.

Future Research Work

- * Analytical models describing the connection between moisture on surfaces and the climate surrounding the structures

* TOW-THRESHOLD VALUES



Norwegian Institute for Air Research (NILU)
P.O. Box 100, N-2007 Kjeller, Norway

REPORT SERIES OPPDRAGSRAPPORT	REPORT NO. OR 37/94	ISBN-82-425-0586-1	
DATE 4.8.1994	SIGN. <i>Storland</i>	NO. OF PAGES 140	PRICE NOK 180,-
TITLE The EUREKA project EU 615 EUROCORE WETCORR Report from the NBS-MK seminar at ABB Conference Centre, Billingstad, 24 November 1993		PROJECT LEADER Jan F. Henriksen	
		NILU PROJECT NO. O-91023	
AUTHOR(S) Jan F. Henriksen and Svein E. Haagenrud		CLASSIFICATION * A	
		CLIENT'S REF. BA 29794	
CLIENT The Research Council of Norway Rosenkrantsgt. 3 N-5003 BERGEN			
ABSTRACT The EUREKA project EU 615 EUROCORE WETCORR aims at an industrialization of NILU's instrument for measuring the real time of wetness (WETCORR instrument) on materials exposed. 10 instruments in a 0-series production has been tested by several specialists in Nordic and European R&D projects. The report gives the conclusions from the second seminar. The instruments follow the specifications given. Proposals for further improvements both for the sensor as well as for the presentation package were discussed.			
NORWEGIAN TITLE WETCORR-instrument for måling av våttid og temperatur - Rapport fra et NBS-MK-seminar 24. november 1993.			
DESCRIPTORS Time of wetness	Instrument	EUROCORE	
ABSTRACT (in Norwegian) EU 615 EUROCORE WETCORR er et EUREKA-prosjekt som har som mål å industrialisere et måleinstrument for bestemmelse av den reelle våttiden på materialer. Rapporten summerer opp resultatene etter 1-2 års utprøving hos ulike brukere av en 0-serie på 10 instrumenter. Resultatene viser at instrumentene holder de kravspesifikasjoner som er gitt. Det er imidlertid behov for videreutvikling på deler av instrumentet, spesielt for sensorer og databehandling.			

- * Classification
- A Unclassified (can be ordered from NILU)
 - B Restricted distribution
 - C Classified (not to be distributed)